

**MILBANK**<sup>®</sup>  
ENERGY AT WORK



# Indiana

*Meter Mounting Equipment*



# Milbank Overview

*Energy At Work since 1927*

Milbank designs and manufactures electrical solutions that move and manage power for the residential, commercial, industrial, utility and transportation sectors. With more than 90 years of expertise in electrical engineering design and manufacturing, Milbank's portfolio includes metering equipment, enclosures and enclosed controls. Founded in 1927, Milbank is a family-owned, American manufacturer headquartered in Kansas City, Mo. For more information, please visit [milbankworks.com](http://milbankworks.com).



## METERING

As a market leader in electrical metering equipment, Milbank has set the standard for quality since 1927. Hundreds of configurations are available, including many sizes, knockout configurations, terminal configurations, bypass options, hubs, locks and connectors. Milbank has the socket you need with thousands of active products to meet your utility's requirements.



## ENCLOSURES

Milbank's line of enclosures include commercial junction boxes, panel mount enclosures, transformer cabinets, wireway and troughs. Built with high-quality craftsmanship and materials which meet or exceed industry standards, Milbank enclosures are made to protect controls and equipment from dust, dirt and other harmful elements found in a wide variety of environments based on various NEMA ratings Milbank offers.



## ENCLOSED CONTROLS

Milbank doesn't just build empty enclosures. We can deliver the entire package, complete with custom control equipment built to your exact specifications by our engineers. Milbank enclosed controls are an attractive, secure, easy to install and cost-effective solution when underground remote site power distribution and control equipment is required, replacing unsightly and inefficient strut and backboard structures.



Please consult serving utility for their requirements prior to ordering or installing, as specifications and approvals vary by utility, and may require local electrical inspector approval. All installations must be installed by a licensed electrician and must comply with all national and local codes, laws and regulations. Milbank reserves the right to make changes in specifications and features shown without notice or obligation.

# Table of Contents

## Air Conditioner Disconnects

30-60 Amps AC disconnects .....	6
60 Amps AC disconnect with 20 Amps GFCI receptacle.....	7
Hot tub disconnects.....	8

## Single Position Sockets

125-200 Amps, 4 terminal, ringless .....	9
200 Amps, 4, 5 & 7 terminal, ringless, lever bypass .....	10
320 Amps, 4 terminal, ringless, side wireway, lever bypass .....	11
320 Amps, 7 terminal, side wireway, ringless, lever bypass .....	12

## Unmetered Load Centers

200 Amps, unmetered load center with main breaker.....	13
--	----

## Meter Mains

125-200 Amps, 4 terminal, ringless .....	14
200 Amps, 4 terminal, load center, ringless, horn bypass .....	15
200 Amps, 4 & 7 terminal, ringless, lever bypass .....	16
320 Amps, 4 terminal, ringless, lever bypass .....	17
400 Amps, 4, 5 & 7 terminal, ringless .....	18
400 Amps, 7 terminal, ringless .....	19
200-400 Amps, 4, 5 & 7 terminal, ringless.....	20

## Multi-Position Sockets

150 Amps, 4 terminal, ringless .....	21
200 Amps, 4 terminal, ringless .....	22
Knockout information .....	23

## Lever Bypass Multi-Position Sockets

200 Amps, 5 terminal, ringless .....	24
200 Amps, 7 terminal, ringless .....	25

## Multi-Position Meter Mains

125-200 Amps, 4 terminal, ringless .....	26
Knockout information .....	27
125-200 Amps, 4 terminal, ringless .....	28
Dimensional information.....	29

Please consult serving utility for their requirements prior to ordering or installing, as specifications and approvals vary by utility, and may require local electrical inspector approval. All installations must be installed by a licensed electrician and must comply with all national and local codes, laws and regulations. Milbank reserves the right to make changes in specifications and features shown without notice or obligation.



**Transformer Rated Sockets**

20 Amps, 6, 8 &13 terminal, plunger bypass.....	30
20 Amps, 6, 8 &13 terminal, test switch provision .....	31
80 Amps, 6, 8 &13 terminal, lever bypass .....	32
Test Switches.....	33-34
Current transformer cabinet, panel enclosure .....	35

**Multi-Position Tap Box**

3 phase, aluminum construction, wall or pad mountable.....	36-37
--	-------

**Meter Main with Load Center Pedestal**

100-200 Amps, 4 terminal, ringless .....	38-41
--	-------

**Temp Power**

125 Amps, 4 terminal, ringless .....	42
125 Amps, surface mount, Millennium Series .....	43
125 Amps, power outlet pedestal .....	44-45

**Miscellaneous**

Lighting & Mounting Accessories .....	46-51
Circuit Breakers .....	52-53
Accessories .....	54-56
Enclosed Controls.....	57-66
Reference Information .....	67-71
Index.....	72-74



Please consult serving utility for their requirements prior to ordering or installing, as specifications and approvals vary by utility, and may require local electrical inspector approval. All installations must be installed by a licensed electrician and must comply with all national and local codes, laws and regulations. Milbank reserves the right to make changes in specifications and features shown without notice or obligation.

# Catalog Number Logic

How our product catalog numbers are derived

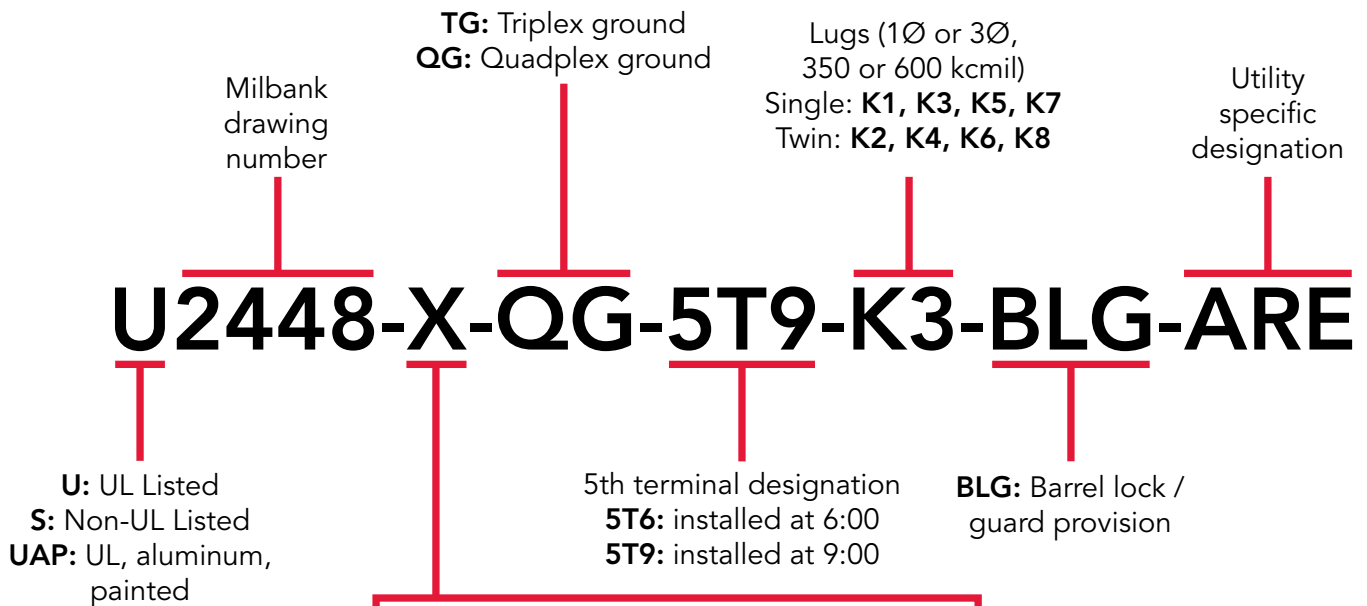

Hub Openings & Closing Plates	
<b>-O</b> Blank top	<b>-PXL</b> Closing plate packed inside
<b>-RL</b> Small hub opening	<b>-WL</b> 1" hub
<b>-R</b> Large hub opening	<b>-YL</b> 1¼" hub
<b>-XL</b> Small closing plate	<b>-ZL</b> 1½" hub
<b>-XT</b> (2) Large Closing plates	<b>-DL</b> 2" hub
<b>-XTL</b> (2) Small closing plates	<b>-EL</b> 2½" hub
<b>-X</b> Large closing plate	<b>-F</b> 3" hub
<b>-RXL</b> Large hub opening adapted to small closing plate	<b>-G</b> 3½" hub
<b>-RRL</b> Large hub opening adapted to small hub opening	<b>-H</b> 4" hub

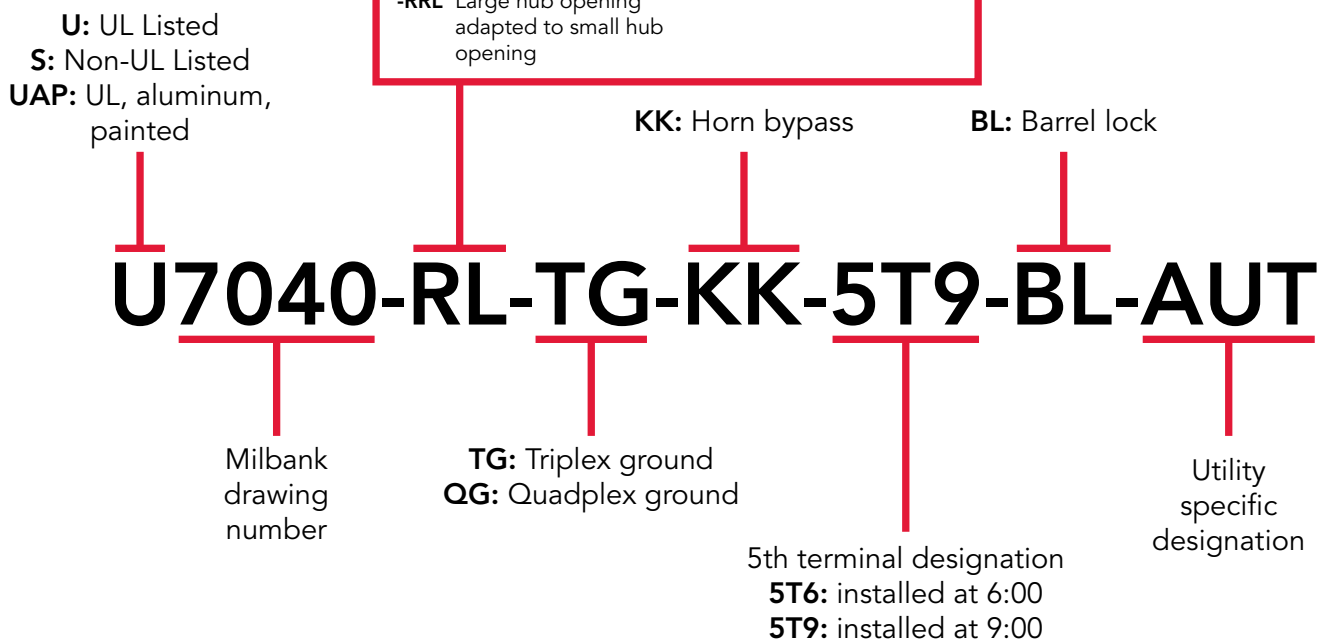

Please consult serving utility for their requirements prior to ordering or installing, as specifications and approvals vary by utility, and may require local electrical inspector approval. All installations must be installed by a licensed electrician and must comply with all national and local codes, laws and regulations. Milbank reserves the right to make changes in specifications and features shown without notice or obligation.



# Air Conditioner Disconnects

30-60 Amps | Fusible & Non-Fusible



**U3802**



**U3812**



**U3832**

Milbank's air conditioner disconnect has a removable hinged cover for ease of installation. Our compact design meets NEC wiring space requirements and also complies with NEC article 440-14. For safe working conditions, our disconnect pullers may be removed and reinstalled in the OFF position. Additionally, padlock provisions are included on the front cover. As with other Milbank products, our enclosure is constructed of G90U galvanized steel and electrostatically finished with an attractive, light gray, baked powder coating. Our epoxy/polyester resin blend offers a finish that is both durable and fade-resistant.

## 30-60 Amps | 1Ø 240 VAC | Air Conditioner Disconnects

Catalog Number	Amps	Type	Max H.P.	Weight (lbs.)	Line/Load Wire Range		Ground Wire Range CU/AL	Dimensions			Wire Rating	
					CU	AL		D"	W"	H"	CU °C	AL °C
<b>U3802</b>	60	Non-Fusible	10	3.25	#14-#2	#12-#2	#14-4	2½	5	7½	60°/75°	60°/75°
<b>U3812</b>	60	Non-Auto	10	3.25	#14-#2	#12-#2	#14-4	2½	5	7½	60°/75°	60°/75°
<b>U3832</b>	30	Fusible	3	2.5	#14-#3	#14-#3	#14-3	2½	5	7	60°/75°	60°/75°
<b>U3862</b>	60	Fusible	10	3.3	#14-#3	#14-#3	#14-3	2½	5	9	60°/75°	60°/75°

### Notes

- UL listed as Enclosed Pullout Switch
- Type 3R
- Weather resistant
- One-inch concentric knockouts



Please consult serving utility for their requirements prior to ordering or installing, as specifications and approvals vary by utility, and may require local electrical inspector approval. All installations must be installed by a licensed electrician and must comply with all national and local codes, laws and regulations. Milbank reserves the right to make changes in specifications and features shown without notice or obligation.

# Air Conditioner Disconnects

## 20 Amps GFCI Receptacle



U3822-20GWR

### Specifications

- Meets NEC #210.63 requirements
- UL listed as Power Outlet
- Type 3R enclosure
- In-use cover\*
- Duplex ground connector
- 1" concentric knockouts
- 1Ø, 240 volt
- 60 Amps, non-fused
- 20 Amps GFCI receptacle
- Reset/test button
- Weather and tamper resistant
- Meets NEC #406.8 requirements

### 60 Amps | 1Ø, 240 VAC | Air Conditioner Disconnect with GFCI Receptacle

Catalog Number	Type	Max H.P.	Weight (lbs.)	Line/Load Wire Range		Ground Wire Range CU/AL	Dimensions			Wire Rating	
				CU	AL		D"	W"	H"	CU °C	AL °C
U3822-20GWR	Non-Fusible	10	6	#14-#2	#12-#2	#14-4	4 $\frac{1}{8}$	5 $\frac{1}{4}$	7 $\frac{1}{2}$	60°/75°	60°/75°

### Notes

- **Disconnect pullers:** To ensure the safest conditions, Milbank disconnect pullers are reversible so they may be reinstalled in the OFF position.
- **Padlock provision:** All units are designed with a padlock provision on the cover for security.
- **\*In-use cover:** Cover is rated as an in-use cover (cover may be closed with cords plugged into receptacle).

Please consult serving utility for their requirements prior to ordering or installing, as specifications and approvals vary by utility, and may require local electrical inspector approval. All installations must be installed by a licensed electrician and must comply with all national and local codes, laws and regulations. Milbank reserves the right to make changes in specifications and features shown without notice or obligation.





# Hot Tub Disconnects

## Type 3R Enclosures



**U4881-O-50GB**



**U4881-O-60GB**

### Specifications

- 240 volt ground fault protection
- UL listed
- Type 3R
- Weather resistant
- 2-pole, 50 or 60 Amps GFCI breaker protection
- Compact size
- Three or four wire installation
- 1Ø, 120/240 VAC
- Standard package of 12
- Two extra one-pole breaker spaces
- 100 Amps overall rating
- Easy to install

### 100 Amps | Hot Tub Disconnect or Sub Panel Breaker Enclosure | Type 3R

Catalog Number	Breaker Amps	Type	Weight (lbs.)	Line/Load Wire Range		Ground Wire Range CU/AL	Dimensions		
				CU	AL		D"	W"	H"
<b>U4881-O-50GB</b>	50	Breaker	8	#14-1/0	#14-1/0	#14-1/0	3¾	7½	8½
<b>U4881-O-60GB</b>	60	Breaker	8	#14-1/0	#14-1/0	#14-1/0	3¾	7½	8½



Please consult serving utility for their requirements prior to ordering or installing, as specifications and approvals vary by utility, and may require local electrical inspector approval. All installations must be installed by a licensed electrician and must comply with all national and local codes, laws and regulations. Milbank reserves the right to make changes in specifications and features shown without notice or obligation.



# Single Position Sockets

125-200 Amps | 4 Terminal | Ringless | 600 VAC

9

125-200 AMPS  
SINGLE  
POSITION



U7487-RL-TG-KK

U7040-RL-TG-KK

U4532-XL

U1980-O-KK

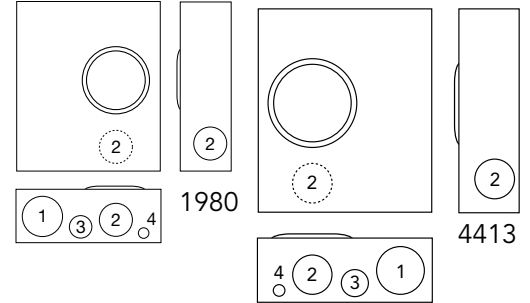
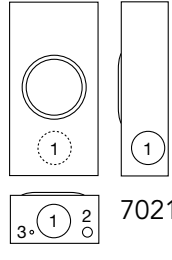
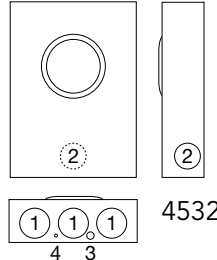
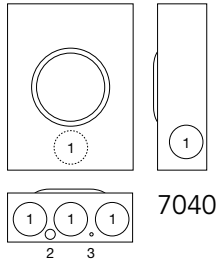
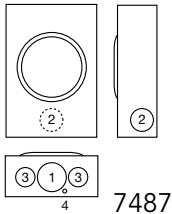

## 4 Terminal | Single Position | Ringless | 1Ø3W

Catalog Number	Amps	Service	Hub	Connectors CU/AL			Bypass	Dimensions			Knockouts			
				Line	Load			D"	W"	H"	1	2	3	4
U7487-RL-TG-KK	125	OH/UG	H.O.	#6-2/0	#6-2/0	Horn	3 <sup>5</sup> / <sub>16</sub>	8	11 <sup>1</sup> / <sub>2</sub>	2	1 <sup>1</sup> / <sub>2</sub>	1 <sup>1</sup> / <sub>4</sub>	1 <sup>1</sup> / <sub>4</sub>	
U7487-RL-TG-KK-BLG	125	OH/UG	H.O.	#6-2/0	#6-2/0	Horn	3 <sup>5</sup> / <sub>16</sub>	8	11 <sup>1</sup> / <sub>2</sub>	2	—	1 <sup>1</sup> / <sub>4</sub>	1 <sup>1</sup> / <sub>4</sub>	
U7021-RL-TG-KK	200	OH	H.O.	#6-350	#6-350	Horn	4 <sup>1</sup> / <sub>8</sub>	8	15 <sup>1</sup> / <sub>2</sub>	2 <sup>1</sup> / <sub>2</sub>	1 <sup>1</sup> / <sub>4</sub> , 1 <sup>1</sup> / <sub>2</sub>	1 <sup>1</sup> / <sub>4</sub>	—	
U7021-RL-TG-KK-BLG	200	OH	H.O.	#6-350	#6-350	Horn	4 <sup>1</sup> / <sub>8</sub>	8	15 <sup>1</sup> / <sub>2</sub>	2 <sup>1</sup> / <sub>2</sub>	1 <sup>1</sup> / <sub>4</sub> , 1 <sup>1</sup> / <sub>2</sub>	1 <sup>1</sup> / <sub>4</sub>	—	
U7040-RL-TG-KK	200	OH/UG	H.O.	#6-350	#6-350	Horn	4 <sup>1</sup> / <sub>8</sub>	11	14 <sup>5</sup> / <sub>8</sub>	2 <sup>1</sup> / <sub>2</sub>	1 <sup>1</sup> / <sub>4</sub> , 1 <sup>1</sup> / <sub>2</sub>	1 <sup>1</sup> / <sub>4</sub>	—	
U7040-RL-TG-KK-BLG	200	OH/UG	H.O.	#6-350	#6-350	Horn	4 <sup>1</sup> / <sub>8</sub>	11	14 <sup>5</sup> / <sub>8</sub>	2 <sup>1</sup> / <sub>2</sub>	1 <sup>1</sup> / <sub>4</sub> , 1 <sup>1</sup> / <sub>2</sub>	1 <sup>1</sup> / <sub>4</sub>	—	
U7040-XL-TG-KK	200	OH/UG	C.P.	#6-350	#6-350	Horn	4 <sup>1</sup> / <sub>8</sub>	11	14 <sup>5</sup> / <sub>8</sub>	2 <sup>1</sup> / <sub>2</sub>	1 <sup>1</sup> / <sub>4</sub> , 1 <sup>1</sup> / <sub>2</sub>	1 <sup>1</sup> / <sub>4</sub>	—	
U4532-XL	200	OH/UG	C.P.	#6-350	(2) #6-350	None	4 <sup>1</sup> / <sub>8</sub>	15	20 <sup>1</sup> / <sub>2</sub>	3	2 <sup>1</sup> / <sub>2</sub>	1 <sup>1</sup> / <sub>4</sub> , 1 <sup>1</sup> / <sub>2</sub>	1 <sup>1</sup> / <sub>4</sub>	

## 200 Amps | 4 Terminal | Single Position | Ringless | Side Wireway | 1Ø3W

Catalog Number	Service	Hub	Connectors CU/AL			Bypass	Dimensions			Knockouts			
			Line	Load			D"	W"	H"	1	2	3	4
U1980-O-KK	UG	Blank	#6-350	#6-350	Horn	4 <sup>1</sup> / <sub>2</sub>	13	15 <sup>1</sup> / <sub>4</sub>	3	2 <sup>1</sup> / <sub>2</sub>	1 <sup>1</sup> / <sub>2</sub>	1 <sup>1</sup> / <sub>4</sub> , 1 <sup>1</sup> / <sub>2</sub>	
U1980-O-KK-BLG	UG	Blank	#6-350	#6-350	Horn	4 <sup>1</sup> / <sub>2</sub>	13	15 <sup>1</sup> / <sub>4</sub>	3 <sup>1</sup> / <sub>2</sub>	2 <sup>1</sup> / <sub>2</sub>	1 <sup>1</sup> / <sub>2</sub>	1 <sup>1</sup> / <sub>4</sub> , 1 <sup>1</sup> / <sub>2</sub>	
U4413-O-KK-BLG	UG	Blank	#6-350	#6-350	Horn	4 <sup>1</sup> / <sub>2</sub>	13	15 <sup>1</sup> / <sub>4</sub>	3	2 <sup>1</sup> / <sub>2</sub>	1 <sup>1</sup> / <sub>2</sub>	1 <sup>1</sup> / <sub>4</sub> , 1 <sup>1</sup> / <sub>2</sub>	

## Notes

- **Hubs:** Order hubs separately — see accessory page for ordering information.
- **Fifth terminal:** For field mounted fifth terminal for **U7021**, **U7040**, **U4532** and **U1980**, order catalog number **K5T**. For the **U7487**, order catalog number **5T8K2**.
- **Connectors:** Extruded aluminum connectors are tin plated.
- **U4532:** Includes twin lug connector on load side.
- **Tap connector:** For tap connector, order **K4977-INT**.
- **Product numbers with BLG are used in AEP service areas.**

Please consult serving utility for their requirements prior to ordering or installing, as specifications and approvals vary by utility, and may require local electrical inspector approval. All installations must be installed by a licensed electrician and must comply with all national and local codes, laws and regulations. Milbank reserves the right to make changes in specifications and features shown without notice or obligation.



# Single Position Lever Bypass

200 Amps | 4, 5 & 7 Terminal | Ringless | 600 VAC



**U3278-RL**

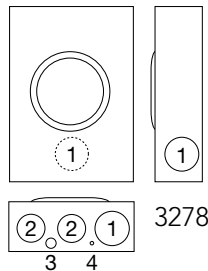

**U9551-RRL**

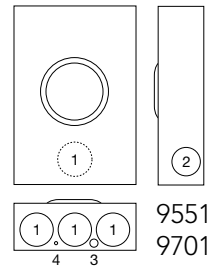

**U9701-RRL**

**200 Amps | Single Position | Lever Bypass | Ringless | Non-Jaw Clamping**

Catalog Number	Terminal	Phase	Service	Hub	Connectors CU/AL	Dimensions			Knockouts			
						D"	W"	H"	1	2	3	4
U3278-RL	4	1Ø3W	OH	H.O.	#6-350	4 <sup>7</sup> / <sub>8</sub>	11	15 <sup>1</sup> / <sub>2</sub>	2 <sup>1</sup> / <sub>2</sub>	2	¼, ½	¼

**200 Amps | Single Position | Heavy Duty Lever Bypass | Ringless | Jaw Clamping**

Catalog Number	Terminal	Phase	Service	Hub	Connectors CU/AL	Dimensions			Knockouts			
						D"	W"	H"	1	2	3	4
U9551-RRL	5	1Ø3W or 3Ø3W	OH/UG	H.O.	#6-350	4 <sup>7</sup> / <sub>8</sub>	13	19	3	2 <sup>1</sup> / <sub>2</sub>	¼, ½	¼
U9701-RRL*	7	3Ø4W	OH/UG	H.O.	#6-350	4 <sup>7</sup> / <sub>8</sub>	13	19	3	2 <sup>1</sup> / <sub>2</sub>	¼, ½	¼
U9701-RRL-BLG*	7	3Ø4W	OH/UG	H.O.	#6-350	4 <sup>7</sup> / <sub>8</sub>	13	19	3	2 <sup>1</sup> / <sub>2</sub>	¼, ½	¼

**Notes**

- **Hubs:** For proper hub selection, see the hub suffix chart on the accessory page.
  - **Connectors:** Extruded aluminum connectors are tin plated.
  - **Bypass:** The lever on the **U3278** unit operates the bypass device only; it does not provide clamping action on the meter spades. The levers on the **U9551** and **U9701** units supply clamping action on meter spades and also operate the bypass devices.
  - **Product numbers with BLG are used in AEP service areas.**
- \*Can be used in a 100 Amps 3 phase applications due to lug range.



Please consult serving utility for their requirements prior to ordering or installing, as specifications and approvals vary by utility, and may require local electrical inspector approval. All installations must be installed by a licensed electrician and must comply with all national and local codes, laws and regulations. Milbank reserves the right to make changes in specifications and features shown without notice or obligation.

# Single Position Lever Bypass

320 Amps | 4 Terminal | Ringless | 600 VAC

**1 1**  
320 AMPS  
SINGLE  
POSITION  
LEVER BYPASS



U4363-X-QG-K3-K2

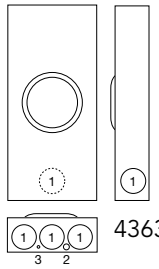

4363



U1079-RRL-K3

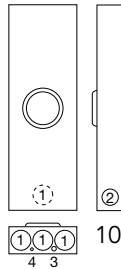

1079



U1129-O-K3L-K2L

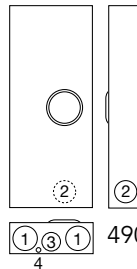

4905



U1797-O-K3L-K2L

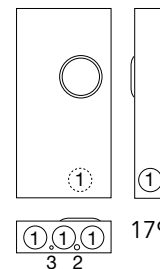

1797

320 Amps Continuous (400 Amps Max) | 4 Terminal | Single Position | Ringless | 1Ø3W

Catalog Number	Service	Hub	Connectors CU/AL		Bypass	Dimensions			Knockouts			
			Line	Load		D"	W"	H"	1	2	3	4
U4363-X-QG-K3-K2	OH	C.P.	(1) #4-600 or (2) 1/0-250	(2) #6-350	Lever	4 <sup>7</sup> / <sub>8</sub>	13	28 <sup>1</sup> / <sub>4</sub>	3	1/4, 1/2	1/4	—
U1079-RRL-K3	OH	H.O.	(1) #4-600 or (2) 1/0-250	3/8" x 16 Studs	Lever	4 <sup>7</sup> / <sub>8</sub>	13	38 <sup>3</sup> / <sub>4</sub>	3	2 <sup>1</sup> / <sub>2</sub>	1/4, 1/2	1/4
U4905-X	OH/UG	C.P.	3/8" x 16 Studs	3/8" x 16 Studs	Lever	5 <sup>3</sup> / <sub>4</sub>	16	38 <sup>3</sup> / <sub>4</sub>	4	3 <sup>1</sup> / <sub>2</sub>	3	1/4, 1/2
U4905-X-BLG	OH/UG	C.P.	3/8" x 16 Studs	3/8" x 16 Studs	Lever	5 <sup>3</sup> / <sub>4</sub>	16	38 <sup>3</sup> / <sub>4</sub>	4	3 <sup>1</sup> / <sub>2</sub>	3	1/4, 1/2
U5161-X-K3L-K2L-BLG	OH/UG	C.P.	(1) #4-600 or (2) 1/0-250	(2) #6-350	Lever	4 <sup>7</sup> / <sub>8</sub>	15	3 <sup>1</sup> / <sub>2</sub>	3	1/4, 1/2	1/4	—
U1129-O-K3L-K2L	UG	Blank	(1) #4-600 or (2) 1/0-250	(2) #6-350	Lever	4 <sup>7</sup> / <sub>8</sub>	15	30	3	1/4, 1/2	1/4	—
U1797-O-K3L-K2L	UG	Blank	(1) #4-600 or (2) 1/0-250	(2) #6-350	Lever	4 <sup>7</sup> / <sub>8</sub>	15	30	3	1/4, 1/2	1/4	—
U1797-O-K3L-K2L-BLG	UG	Blank	(1) #4-600 or (2) 1/0-250	(2) #6-350	Lever	4 <sup>7</sup> / <sub>8</sub>	15	30	3	1/4, 1/2	1/4	—

## Notes

- **Side wireway:** U1797 and U4905 are side wireway units.
- **Bypass:** Lever supplies clamping action and also operates bypass device.
- **Hubs:** For proper hub selection, see the hub suffix chart on the accessory page.
- **Connectors:** Some units supplied with 3/8" x 16 hex head nuts with Belleville washers. For connector kits, order as extra K1540 (single 600 kcmil). For twin lug connectors, order as extra K1350 (twin 350 kcmil). Order two kits to cover both line and load on U4905 and one kit for load side of U1079.
- **Fifth terminal:** For factory-installed fifth terminal in the 6 o'clock position, add the suffix -5T6 to the catalog number. For factory-installed fifth terminal in the 9 o'clock position, add the suffix -5T9 to the catalog number. For field-installed fifth terminal, order as extra catalog number K3865 for U1129, U1797 and U4905 and K3866 for U1079.
- **Product numbers with BLG are used in AEP service areas.**

Please consult serving utility for their requirements prior to ordering or installing, as specifications and approvals vary by utility, and may require local electrical inspector approval. All installations must be installed by a licensed electrician and must comply with all national and local codes, laws and regulations. Milbank reserves the right to make changes in specifications and features shown without notice or obligation.



# Single Position Lever Bypass

320 Amps | 7 Terminal | Ringless | 600 VAC



U2120-X-K7

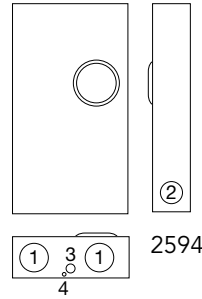
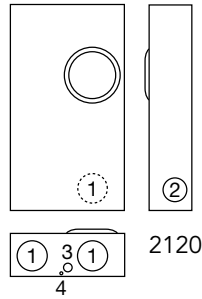

U2594-X

320 Amps | 7 Terminal | Single Position | Ringless | Side Wireway | 3Ø4W | Jaw Clamping

Catalog Number	Service	Hub	Connectors CU/AL		Bypass	Dimensions			Knockouts			
			Line	Load		D"	W"	H"	1	2	3	4
U2594-X	OH/UG	C.P.	3/8" x 16 Studs	3/8" x 16 Studs	Lever	6 1/2	19	34 1/8	4	3	1	1/4
U2594-X-BLG	OH/UG	C.P.	3/8" x 16 Studs	3/8" x 16 Studs	Lever	6 1/2	19	34 1/8	4	3	1	1/4
U2120-X-K7	UG	C.P.	(1) #4-600 or (2) 1/0-250	3/8" x 16 Studs	Lever	6 1/2	17 3/4	31 3/4	4	3	1	1/4

## Notes

- **Hubs:** For proper hub selection, see the hub suffix chart on the accessory page.
- **Bypass:** Lever supplies clamping action and also operates bypass device.
- **Connectors:** Supplied with 3/8" x 16 hex head nuts with Belleville washers. For connector kits, order as extra **K3441** (single 600 kcmil). For twin lug connectors, order as extra **K3442** (twin 350 kcmil). Separate kits are required for both line and load. Line side connectors furnished on **U2120**.
- **Product numbers with BLG are used in AEP service areas.**



Please consult serving utility for their requirements prior to ordering or installing, as specifications and approvals vary by utility, and may require local electrical inspector approval. All installations must be installed by a licensed electrician and must comply with all national and local codes, laws and regulations. Milbank reserves the right to make changes in specifications and features shown without notice or obligation.

# Unmetered Load Centers

200 Amps | 120/240 VAC

**13**  
200 AMPS  
UNMETERED  
LOAD CENTERS



USE-22-200-MB

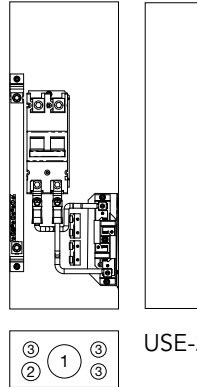

USE-22



U5971-XL-200

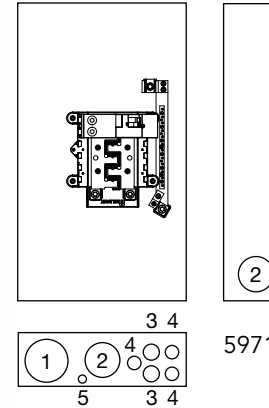

5971

## 200 Amps | Unmetered Load Center with Main Breaker

Catalog Number	Main Breaker Amp	Circuits	Service	Hub	Dimensions			Knockouts				
					D"	W"	H"	1	2	3	4	5
USE-22-200-MB	200	4	OH	2"	4	8	23	2	1	1/2, 3/4	—	—
U5971-XL-100	100	10	OH/UG	C.P.	4 1/2	14 1/8	25 1/6	3	2	1	1/2, 3/4	1/4, 1/2
U5971-XL-150	150	8	OH/UG	C.P.	4 1/2	14 1/8	25 1/6	3	2	1	1/2, 3/4	1/4, 1/2
U5971-XL-200	200	8	OH/UG	C.P.	4 1/2	14 1/8	25 1/6	3	2	1	1/2, 3/4	1/4, 1/2

### Notes

- **AIC Rating:** This units are rated 22K AIC.
- **Breaker interlock:** U5971 accepts breaker interlock kits — order **K5815** for large QN with small frame Q, **K5820** for large frame QN with large frame QN, or **K5830** for small frame Q to small frame Q.

Please consult serving utility for their requirements prior to ordering or installing, as specifications and approvals vary by utility, and may require local electrical inspector approval. All installations must be installed by a licensed electrician and must comply with all national and local codes, laws and regulations. Milbank reserves the right to make changes in specifications and features shown without notice or obligation.





U3989-XL

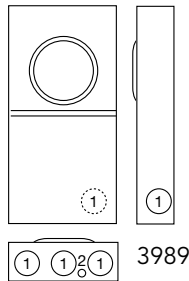

U3491-XL-200

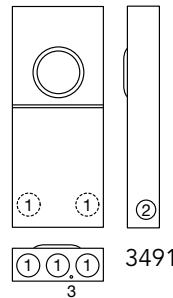

U5844-PXL-200-KK

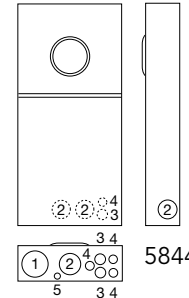

### 4 Terminal | Meter Mains | Ringless | 1Ø3W

Catalog Number	Service	Amp	Hub	Connectors CU/AL		Bypass	Dimensions			Knockouts				
				Line	Load		D"	W"	H"	1	2	3	4	5
U3989-XL	OH/UG	125	C.P.	#6-2/0	CB	None	3¾	11	22	2	¼, ½	—	—	—
U3491-XL-200	OH/UG	200	C.P.	#2-350	CB	None	4⅞	12	29	2½	2	¼	—	—
U5844-PXL-200-KK	OH/UG	200	C.P.	#6-350	CB	Horn	4½	14	30	3	2½	1	½, ¾	¼, ½
U5844-PXL-200-KK-BLG	OH/UG	200	C.P.	#6-350	CB	Horn	4½	14	30	3	2½	1	½, ¾	¼, ½

### Notes

- **Hubs:** For proper hub selection, see the hub suffix chart on the accessory page.
- **Breaker:** For replacement breakers for **U5844** order **QN2200H**. For **U3989**, order approved small frame breakers 125 amps or less per the rating label.
- **Fifth terminal:** For field installable fifth terminal kit, order **K5T**.
- **AIC rating:** The **U5844** is 22K AIC rated.
- **PXL** - Closing plate packed inside of carton.
- **Product numbers with BLG are used in AEP service areas.**



Please consult serving utility for their requirements prior to ordering or installing, as specifications and approvals vary by utility, and may require local electrical inspector approval. All installations must be installed by a licensed electrician and must comply with all national and local codes, laws and regulations. Milbank reserves the right to make changes in specifications and features shown without notice or obligation.

# Meter Main With Load Center

200 Amps | 4 Terminal | Ringless | 120/240 VAC

**15**  
200 AMPS  
METER MAIN  
WITH LOAD  
CENTER



U5168-XTL-200-KK

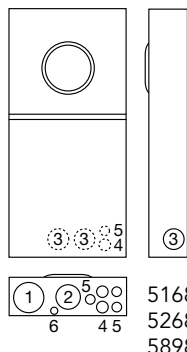

U5268-XTL-200-KK

Knockouts					
1	2	3	4	5	6
3	2½	2	1	½,¾	¼,½

200 Amps | 4 Terminal | Meter Mains | Horn Bypass | Ringless | 1Ø3W

Catalog Number	Breaker Amps	Circuits	Service	Hub	Connectors CU/AL - Line	Dimensions		
						D"	W"	H"
U5168-XTL-100-KK	100	10	OH/UG	C.P.	#6-350	4½	14⅞	32
U5168-XTL-100-KK-BLG	100	10	OH/UG	C.P.	#6-350	4½	14⅞	32
U5168-XTL-150-KK	150	8	OH/UG	C.P.	#6-350	4½	14⅞	32
U5168-XTL-150-KK-BLG	150	8	OH/UG	C.P.	#6-350	4½	14⅞	32
U5168-XTL-200-KK	200	8	OH/UG	C.P.	#6-350	4½	14⅞	32
U5168-XTL-200-KK-BLG	200	8	OH/UG	C.P.	#6-350	4½	14⅞	32
U5268-XTL-150-KK	150	20	OH/UG	C.P.	#6-350	4½	14⅞	32
U5268-XTL-200-KK	200	20	OH/UG	C.P.	#6-350	4½	14⅞	32
U5268-XTL-200-KK-BLG	200	20	OH/UG	C.P.	#6-350	4½	14⅞	32
U5898-O-200-KK-BLG	200	8	OH/UG	C.P.	#6-350	4½	17	34½
U5898-O-100-KK-BLG	100	10	OH/UG	C.P.	#6-350	4½	17	34½

## Notes

- **Fifth terminal:** For field installed fifth terminal, order **K5T**.
- **Breakers:** Rated 22K AIC with **QN2200H** main installed for **U5168** and **U5268**.
- **Sub feed lugs:** #6-350 sub feed lugs provided on 8 circuit interior. **Not available on 20 circuit interior.**
- **Main lug kit:** Main lug feed-through kit **K3701** available.
- **XTL** - Two small hub closing plate.
- **Product numbers with BLG** are used in AEP service areas.

## Generator Interlock — for use with U5168 and U5268

	K5815	K5820	K5830
	Large QN with small frame Q	Large frame QN with large frame QN	Small frame Q to small frame Q

## Branch Breaker Chart

AIC Rating	Amps	Siemens	Cutler Hammer	General Electric	Square D
10k	150-200	QNR	BR (150A only)	—	—
	≤ 125	QP	HQP, BR	THQL, THQL-GF	Homeline
22k	150-200	QNRH	—	—	—
	≤ 125	QPH	—	—	—

Please consult serving utility for their requirements prior to ordering or installing, as specifications and approvals vary by utility, and may require local electrical inspector approval. All installations must be installed by a licensed electrician and must comply with all national and local codes, laws and regulations. Milbank reserves the right to make changes in specifications and features shown without notice or obligation.





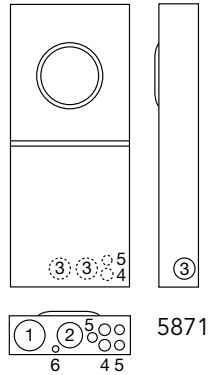

U5871-XL-200

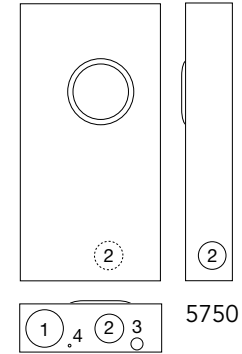

U5750-RXL-200-BL

200 Amps | Meter Main | Lever Bypass | Ringless | Jaw Clamping

Catalog Number	Terminals	Breaker Amps	Service	Hub	Connectors CU/AL - Line	Dimensions			Knockouts					
						D"	W"	H"	1	2	3	4	5	6
U5871-XL-200	4	200	OH/UG	C.P.	#6-350	4½	14⅞	32	3	2½	2	1	½,¾	¼,½
U5750-RXL-200-BL	7	200	OH/UG	C.P.	#6-350	5¾	17⅞	34	4	3	1	¼	—	—

### Notes

- **Breakers:** U5871 is rated 22K AIC with QN2200RH main installed. U5750 is rated 10K AIC with UQFB-3200 main installed.
- **U5871-** Has 8 branch circuits
- **-BL:** Barrel lock
- **Fifth terminal:** For field installed fifth terminal for U5871, order K5T.
- **Interlock kit:** For generator auxiliary circuit breaker interlock for U5871, order K5815 for large QN with small frame Q; order K5820 for large frame QN with large frame QN.



Please consult serving utility for their requirements prior to ordering or installing, as specifications and approvals vary by utility, and may require local electrical inspector approval. All installations must be installed by a licensed electrician and must comply with all national and local codes, laws and regulations. Milbank reserves the right to make changes in specifications and features shown without notice or obligation.

# Lever Bypass Meter Mains

320 Amps | 4 Terminal | Ringless | 120/240 VAC

**17**  
320 AMPS  
LEVER BYPASS  
METER MAINS



U5059-X-2/200



U5890-X-2/200-BL  
(shown with lugs installed)



U5891-X-2/200-MLK-BL



U4835-X-2/200-BL

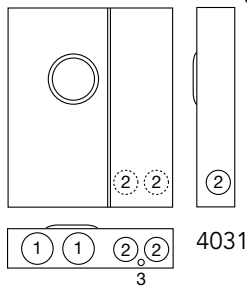

4031

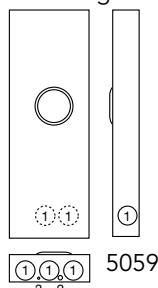

5059

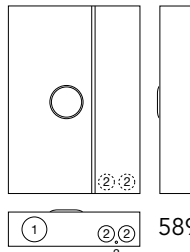

5890

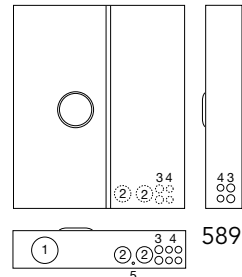

5891

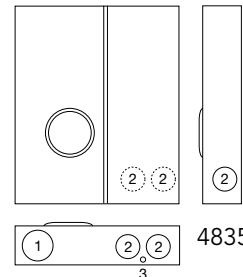

4835

320 Amps | 4 Terminal | Meter Mains | Lever Bypass | Ringless | OH/UG

Catalog Number	Hub	Connectors CU/AL - Line	Breaker Amps	Branch Circuits	Dimensions			Knockouts				
					D"	W"	H"	1	2	3	4	5
U4031-O-2/200	—	3/8" x 16 Studs	200	N/A	5 3/4	25	30	4	4	1/4, 1/2	—	—
U5059-X-K3L	C.P.	(1) #4-600 or (2) 1/0-250	Provision	N/A	4 7/8	15	42	3	1/4, 1/2	1/4	—	—
U5059-X-2/200-K3L	C.P.	(1) #4-600 or (2) 1/0-250	200	N/A	4 7/8	15	42	3	1/4, 1/2	1/4	—	—
U5890-X-2/200-BL*	C.P.	3/8" x 16 Studs	200	N/A	6	24 1/2	35	4	2 1/2	1/4	—	—
U5890-X-2/200-BLG	C.P.	3/8" x 16 Studs	200	N/A	6	24 1/2	35	4	2 1/2	1/4	—	—
U5891-X-2/200-MLK-BL*	C.P.	3/8" x 16 Studs	200	12	6	29 1/2	35	4	2 1/2	1	1/2, 3/4	1/4
U4835-X-2/200-BL	C.P.	3/8" x 16 Studs	200	N/A	5 3/4	24 7/8	30	4	3	1/2	—	—

## Notes

- **AIC rating:** 22K AIC standard.
- **Breakers:** For **U5059** main breakers, order **UQFPH-100, -150, or -200**. For replacement main breaker in **U4835** order Milbank UQFBH series
- **-MLK:** Main Lug feed-through kit **K3701** factory installed.
- **Fifth terminal:** For field mounted fifth terminal order catalog number **K3865**.
- **Connectors:** Supplied with 3/8" x 16 hex head nuts with Belleville washers. For connector kits, order as extra **K1540** (single 600 kcmil). For twin lug connectors, order as extra **K1350** (twin 350 kcmil). The extra stud on line side is a wire stop.
- **Product numbers with BLG are used in AEP service areas (Suffix -BLG is barrel lock with gaurd.)**
- \* Barrel lock (suffix -BL)
- For replacement main breaker in **U5890** order Siemens QN series **QN2200H**.
- For replacement main breaker in **U5891**, order **QN2200H** (for left breaker) and a **QN2200RH** (for right breaker).

Please consult serving utility for their requirements prior to ordering or installing, as specifications and approvals vary by utility, and may require local electrical inspector approval. All installations must be installed by a licensed electrician and must comply with all national and local codes, laws and regulations. Milbank reserves the right to make changes in specifications and features shown without notice or obligation.





U6227-X-400-K3L

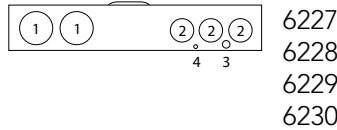
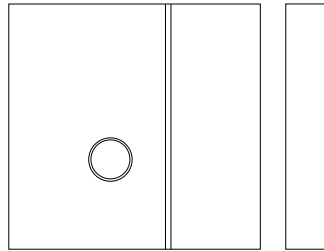

U6230-X-400-K7

**400 Amps Meter Main | 4 & 5 Terminal | 1Ø3W | OH/UG | 240 VAC | Lever Bypass**

Catalog Number	Terminals	Hub	Connectors CU/AL	Dimensions			Knockouts			
			Line	D"	W"	H"	1	2	3	4
U6227-X-400-K3L	4	C.P.	#4-600kcmil or (2) 1/0 - 250	6	36¼	34	4	2½	½	¼
U6228-X-400-K3L	4	C.P.	#4-600kcmil or (2) 1/0 - 250	6	36¼	34	4	2½	½	¼
U6227-X-400-K3L-5T6	5	C.P.	#4-600kcmil or (2) 1/0 - 250	6	36¼	34	4	2½	½	¼
U6227-X-400-K3L-5T9	5	C.P.	#4-600kcmil or (2) 1/0 - 250	6	36¼	34	4	2½	½	¼
U6227-X-400-K3L-BLG	5	C.P.	#4-600kcmil or (2) 1/0 - 250	6	36¼	34	4	2½	½	¼
U6228-X-400-K3L-5T6	5	C.P.	#4-600kcmil or (2) 1/0 - 250	6	36¼	34	4	2½	½	¼
U6228-X-400-K3L-5T9	5	C.P.	#4-600kcmil or (2) 1/0 - 250	6	36¼	34	4	2½	½	¼

### Specifications

- Side buss unit: U6228
- AIC rating : 22K AIC at 240V
- 300 Amps breaker: Can be installed from the factory (upon request)

**400 Amps Meter Main | 7 Terminal | 3Ø4W | OH/UG | 480 VAC | Lever Bypass**

Catalog Number	Hub	Connectors CU/AL	Dimensions			Knockouts			
		Line	D"	W"	H"	1	2	3	4
U6229-X-400-K7L	C.P.	#4-600kcmil or (2) 1/0 - 250	6	36¼	34	4	2½	½	¼
U6229-X-400-K7L-BLG	C.P.	#4-600kcmil or (2) 1/0 - 250	6	36¼	34	4	2½	½	¼
U6230-X-400-K7L	C.P.	#4-600kcmil or (2) 1/0 - 250	6	36¼	34	4	2½	½	¼

### Specifications

- Side buss units: U6230
- AIC rating: 22K AIC at 240V; and 10K AIC at 480V.
- 300 Amps breaker: Can be installed from the factory (upon request).



Please consult serving utility for their requirements prior to ordering or installing, as specifications and approvals vary by utility, and may require local electrical inspector approval. All installations must be installed by a licensed electrician and must comply with all national and local codes, laws and regulations. Milbank reserves the right to make changes in specifications and features shown without notice or obligation.

# Meter Mains

400 Amps | 7 Terminal | Ringless

**19**  
400 AMPS  
METER MAINS



U6115-X-2/200-K7L

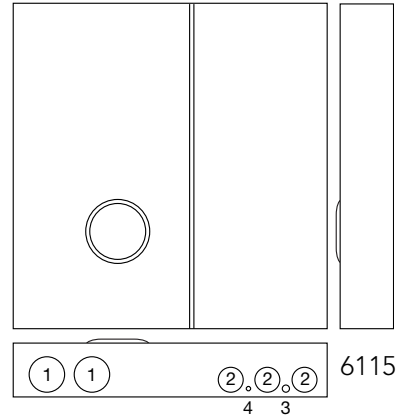

400 Amps Meter Main with Breakers | 7 Terminal | 3Ø4W | Ringless | 480 VAC

Catalog Number	Hub	Connectors CU/AL	Dimensions			Knockouts			
		Line	D"	W"	H"	1	2	3	4
U6115-X-2/200-K7L	C.P.	#4-600kcmil or (2) 1/0 - 250	7	34¼	34	½, ¾	½, ¾	½, ¾	½, ¾
U6115-X-2/200-K7L-BL	C.P.	#4-600kcmil or (2) 1/0 - 250	7	34¼	34	½, ¾	½, ¾	½, ¾	½, ¾
U6115-X-2/200-K7L-BLG	C.P.	#4-600kcmil or (2) 1/0 - 250	7	34¼	34	½, ¾	½, ¾	½, ¾	½, ¾

## Specifications

- U6115-X-2/200-K7L comes with (2) 200A 3Ø breakers

Please consult serving utility for their requirements prior to ordering or installing, as specifications and approvals vary by utility, and may require local electrical inspector approval. All installations must be installed by a licensed electrician and must comply with all national and local codes, laws and regulations. Milbank reserves the right to make changes in specifications and features shown without notice or obligation.



# Cold Sequence Meter Mains

200-400 Amps | 4, 5 & 7 Terminal | Ringless



U5767-X-200-CB



U5787-O-200-CB

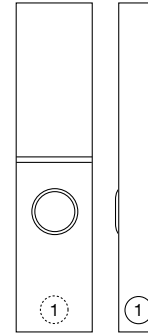

5796

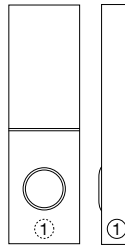

5764 5767  
5765

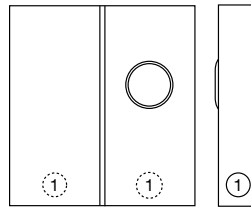

5784 5787

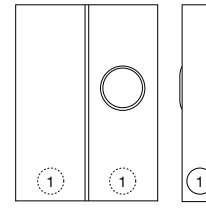

5797 5799

## 200 Amps Circuit Breaker Disconnect Ahead Of Meter Socket | Lever Bypass

Catalog Number	Terminals	Service	Hub	Connectors CU/AL - Load	Phase	Dimensions			Knockouts			
						D"	W"	H"	1	2	3	4
U5764-X-200-CB	4	OH/UG	C.P.	#6-350	1Ø3W	4 <sup>27/32</sup>	13	43	4	2½	¼	—
U5784-O-200-CB	4	UG	Blank	#6-350	1Ø3W or 3Ø3W	4 <sup>27/32</sup>	26	28	4	2½	¼	—
U5765-X-200-CB	5	OH/UG	C.P.	#6-350	1Ø3W or 3Ø3W	4 <sup>27/32</sup>	13	43	4	2½	1	½, ¾
U5767-X-200-CB	7	OH/UG	C.P.	#6-350	3Ø4W	4 <sup>27/32</sup>	13	43	4	2½	1	½, ¾
U5787-O-200-CB	7	UG	Blank	#6-350	3Ø4W	6	26	28	4	2½	1	½, ¾

## 400 Amps (320 Amps Continuous) Circuit Breaker Disconnect Ahead Of Meter Socket | Lever Bypass

Catalog Number	Terminals	Service	Hub	Connectors CU/AL - Load	Phase	Dimensions			Knockouts			
						D"	W"	H"	1	2	3	4
U5797-O-400-CB	4	UG	Blank	3/0-500	1Ø3W or 3Ø3W	6	26	36	4	2½	1	½, ¾
U5796-X-400-CB	7	OH/UG	C.P.	3/0-500	3Ø4W	6	13	56	4	2½	¼	—
U5799-O-400-CB	7	UG	Blank	3/0-500	3Ø4W	6	26	36	4	2½	1	½, ¾

### Notes

- **Hubs:** For proper hub selection, refer to the hub suffix chart on the accessories page.



Please consult serving utility for their requirements prior to ordering or installing, as specifications and approvals vary by utility, and may require local electrical inspector approval. All installations must be installed by a licensed electrician and must comply with all national and local codes, laws and regulations. Milbank reserves the right to make changes in specifications and features shown without notice or obligation.

# Multi-Position Sockets

150 Amps | 4 Terminal | Ringless | 300 VAC

**21**  
150 AMPS  
MULTI-POSITION  
SOCKETS



U1232-RRL-KK-K1

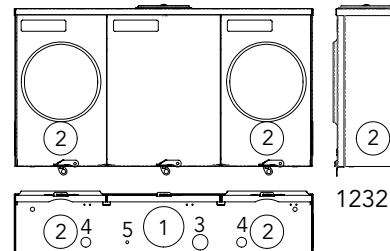

1232

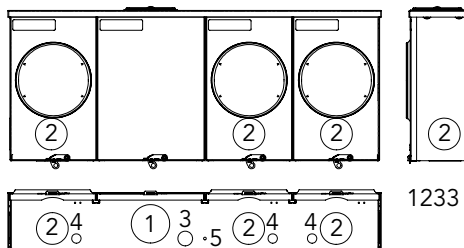

1233

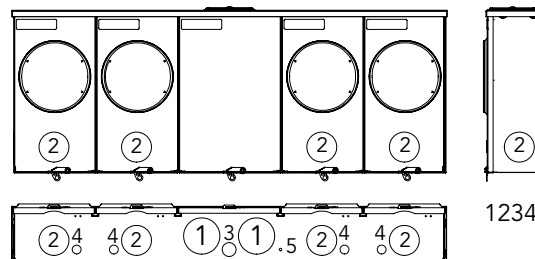

1234

150 Amps per Position | 4 Terminal | Multi-Position | Ringless | Horn Bypass

Catalog Number	Positions	Service	Hub	Connectors CU/AL		Dimensions			Knockouts				
				Line	Load	D"	W"	H"	1	2	3	4	5
U1232-RRL-KK-K1	2	OH/UG	H.O.	#6-350	#6-350	5 $\frac{1}{8}$	26 $\frac{1}{2}$	14	3	2 $\frac{1}{2}$	1	$\frac{1}{2}$	$\frac{1}{4}$
U1233-RRL-KK-K1	3	OH/UG	H.O.	#6-350	#6-350	5 $\frac{1}{8}$	34 $\frac{3}{4}$	14	3	2 $\frac{1}{2}$	1	$\frac{1}{2}$	$\frac{1}{4}$
U1234-RXL-KK-K1	4	OH/UG	C.P.	#6-350	#6-350	5 $\frac{1}{8}$	42 $\frac{7}{8}$	16	3	2 $\frac{1}{2}$	1	$\frac{1}{2}$	$\frac{1}{4}$

## Notes

- **Hubs:** For proper hub selection, refer to the hub suffix chart on the accessories page. For the **U1254-6** two hub openings are supplied and the extra opening is closed with a closing plate as standard.
- **Fifth terminal:** For field mounted fifth terminal, order catalog number **K5T** (9 o'clock position).

Please consult serving utility for their requirements prior to ordering or installing, as specifications and approvals vary by utility, and may require local electrical inspector approval. All installations must be installed by a licensed electrician and must comply with all national and local codes, laws and regulations. Milbank reserves the right to make changes in specifications and features shown without notice or obligation.



# Multi-Position Sockets

200 Amps | 4 Terminal | Ringless | 300 VAC



U1252-RRL-KK-K1-SLVG

200 Amps per Position | 4 Terminal | Multi-Position | Ringless | Horn Bypass

Catalog Number	Positions	Service	Hub	Connectors CU/AL		Dimensions		
				Line	Load	D"	W"	H"
U1252-RRL-KK-K1-SLVG	2	OH/UG	H.O.	#6-350	#6-350	5 $\frac{1}{8}$	26 $\frac{1}{2}$	14
U1252-RRL-KK-K1-BLG-SLVG	2	OH/UG	H.O.	#6-350	#6-350	5 $\frac{1}{8}$	26 $\frac{1}{2}$	14
U1253-RRL-KK-K1-SLVG	3	OH/UG	H.O.	#6-350	#6-350	5 $\frac{1}{8}$	34 $\frac{3}{4}$	14
U1253-RRL-KK-K1-BLG-SLVG	3	OH/UG	H.O.	#6-350	#6-350	5 $\frac{1}{8}$	34 $\frac{3}{4}$	14
U1254-RXL-KK-K1-SLVG	4	OH/UG	C.P.	#6-350	#6-350	5 $\frac{1}{8}$	42 $\frac{7}{8}$	16
U1254-RXL-KK-K1-BLG-SLVG	4	OH/UG	H.O.	#6-350	#6-350	5 $\frac{1}{8}$	42 $\frac{7}{8}$	16
U1255-RXL-KK-K1-SLVG	5	OH/UG	C.P.	#6-350	#6-350	5 $\frac{1}{8}$	54 $\frac{1}{2}$	16
U1255-RXL-KK-K1-BLG-SLVG	5	OH/UG	H.O.	#6-350	#6-350	5 $\frac{1}{8}$	54 $\frac{1}{2}$	16
U1256-RXL-KK-K1-SLVG	6	OH/UG	C.P.	#6-350	#6-350	5 $\frac{1}{8}$	63 $\frac{1}{16}$	18
U1256-RXL-KK-K1-BLG-SLVG	6	OH/UG	H.O.	#6-350	#6-350	5 $\frac{1}{8}$	63 $\frac{1}{16}$	18

## Notes

- **Hubs:** For proper hub selection, refer to the hub suffix chart on the accessories page. For the **U1254-6** two hub openings are supplied and the extra opening is closed with a closing plate as standard.
- **Fifth terminal:** For field mounted fifth terminal, order catalog number **K5T** (9 o'clock position).
- **Product numbers with BLG are used in AEP service areas.**



# Multi-Position Sockets

Knockout information

Knockouts				
1	2	3	4	5
3	2½	1	½	¼

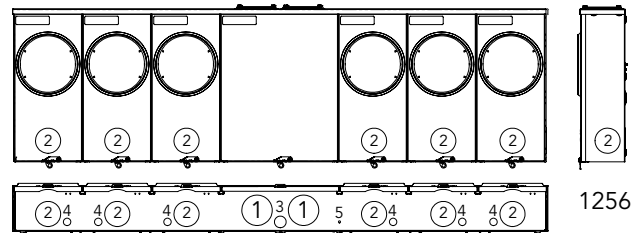
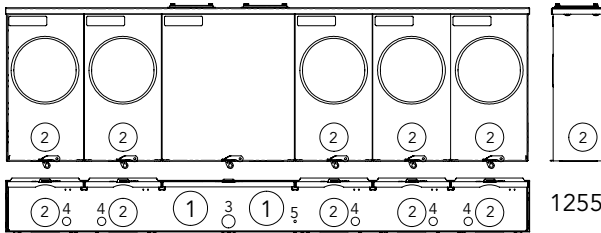
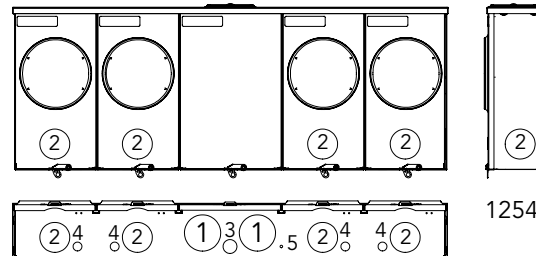
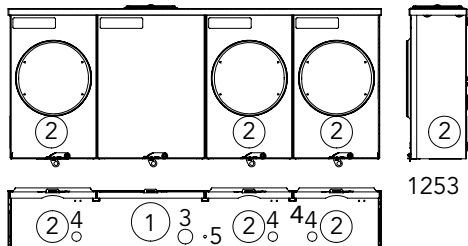
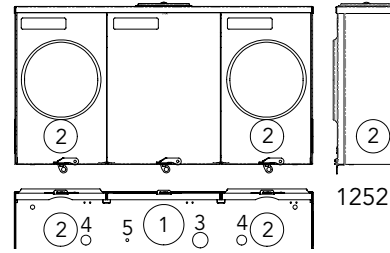

Please consult serving utility for their requirements prior to ordering or installing, as specifications and approvals vary by utility, and may require local electrical inspector approval. All installations must be installed by a licensed electrician and must comply with all national and local codes, laws and regulations. Milbank reserves the right to make changes in specifications and features shown without notice or obligation.



# 24

200 AMPS  
LEVER BYPASS  
MULTI-POSITION

# Lever Bypass Multi-Position Sockets

200 Amps | 5 Terminal | Ringless | 600 VAC



U2873-XT

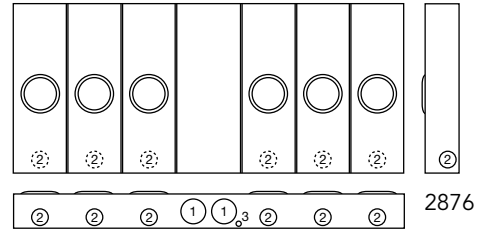
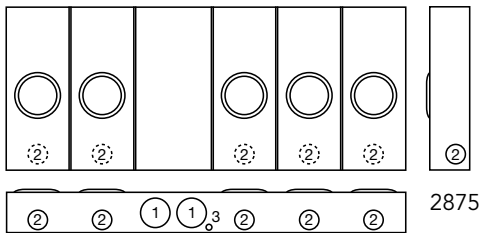
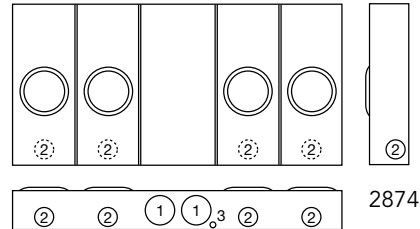
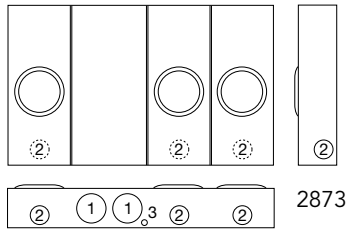
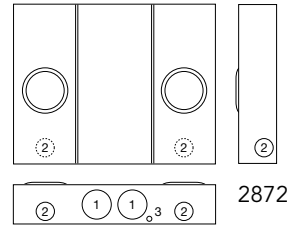

200 Amps per Position | 5 Terminal | Multi-Position | Ringless

Catalog Number	Positions	Service	Hub	Connectors CU/AL		Bypass	Dimensions			Knockouts		
				Line	Load		D"	W"	H"	1	2	3
U2872-XT	2	OH/UG	(2) C.P.	3/8" x 16 Stud	#6-350	Lever	6	32 3/8	25 1/4	4	2 1/2	1/4, 1/2
U2873-XT	3	OH/UG	(2) C.P.	3/8" x 16 Stud	#6-350	Lever	6	42 3/16	25 1/4	4	2 1/2	1/4, 1/2
U2874-XT	4	OH/UG	(2) C.P.	3/8" x 16 Stud	#6-350	Lever	6	52 1/4	25 1/4	4	2 1/2	1/4, 1/2
U2875-XT	5	OH/UG	(2) C.P.	3/8" x 16 Stud	#6-350	Lever	6	62 5/16	25 1/4	4	2 1/2	1/4, 1/2
U2876-XT	6	OH/UG	(2) C.P.	3/8" x 16 Stud	#6-350	Lever	6	72 3/8	31 1/4	4	2 1/2	1/4, 1/2

## Notes

- **Hubs:** Units supplied with two closing plates. To order hubs as extra, refer to the hub suffix chart on the accessories page.
- **Connector Kits:** For line side connector kits, order as extra **K1539** (350 kcmil), **K1540** (600 kcmil), twin **K1350** (350 kcmil), twin **K1541** (600 kcmil). Line connectors can be reversed to change from "OH" to "UG" service. For line side connector lug kits, order as extra from chart on the accessories page.
- **Bypass:** Lever supplies clamping action on meter spades and also operates bypass device.



Please consult serving utility for their requirements prior to ordering or installing, as specifications and approvals vary by utility, and may require local electrical inspector approval. All installations must be installed by a licensed electrician and must comply with all national and local codes, laws and regulations. Milbank reserves the right to make changes in specifications and features shown without notice or obligation.

# Lever Bypass Multi-Position Sockets

200 Amps | 7 Terminal | Ringless | 600 VAC 3 phase

**25**  
200 AMPS  
LEVER BYPASS  
MULTI-POSITION



U2732-XT

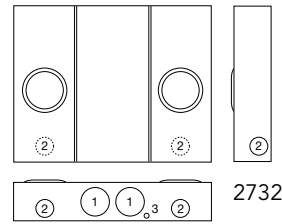

2732

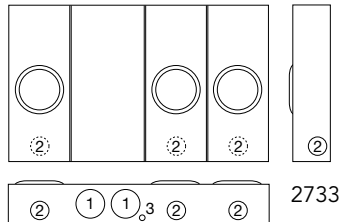

2733

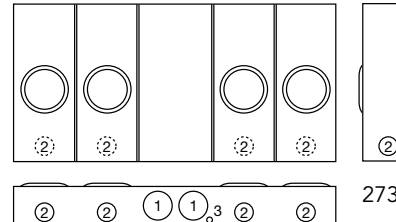

2734

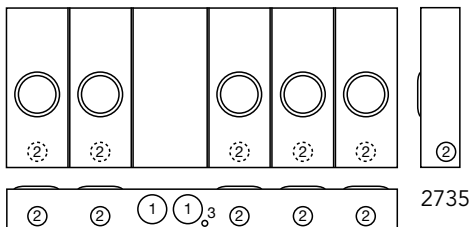

2735

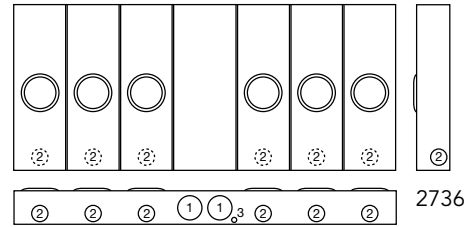

2736

200 Amps per Position | 7 Terminal | Multi-Position | Lever Bypass | Ringless

Catalog Number	Positions	Service	Hub	Connectors CU/AL		Dimensions			Knockouts		
				Line	Load	D"	W"	H"	1	2	3
U2732-XT	2	OH/UG	(2) C.P.	3/8" x 16 Stud	#6-350	6	32 1/8	25 1/4	4	2 1/2	1/4, 1/2
U2733-XT	3	OH/UG	(2) C.P.	3/8" x 16 Stud	#6-350	6	42 3/16	25 1/4	4	2 1/2	1/4, 1/2
U2734-XT	4	OH/UG	(2) C.P.	3/8" x 16 Stud	#6-350	6	52 1/4	25 1/4	4	2 1/2	1/4, 1/2
U2735-XT	5	OH/UG	(2) C.P.	3/8" x 16 Stud	#6-350	6	62 5/16	25 1/4	4	2 1/2	1/4, 1/2
U2736-XT	6	OH/UG	(2) C.P.	3/8" x 16 Stud	#6-350	6	72 3/8	31 1/4	4	2 1/2	1/4, 1/2

## Notes

- **Hubs:** Units supplied with two closing plates. To order hubs as extra, refer to the hub suffix chart on the accessories page.
- **Connector Kits:** For line side connector kits, order as extra **K3082** (350 kcmil), **K3441** (600 kcmil), twin **K3442** (350 kcmil), twin **K3083** (600 kcmil). Line connectors can be reversed to change from "OH" to "UG" service.
- **Bypass:** Lever supplies clamping action on meter spades and also operates bypass device.

Please consult serving utility for their requirements prior to ordering or installing, as specifications and approvals vary by utility, and may require local electrical inspector approval. All installations must be installed by a licensed electrician and must comply with all national and local codes, laws and regulations. Milbank reserves the right to make changes in specifications and features shown without notice or obligation.



# 26

125 & 200 AMPS  
MULTI-POSITION  
METER MAINS

# Multi-Position Meter Mains

125 & 200 Amps per Position | 4 Terminal | Ringless | 120/240

VAC **10K AIC**



**U2854-X**

(Order circuit breakers separately)



**U2866-X**

## 125 Amps per Position | Multi-Position Sockets | 10K AIC | Ringless

Catalog Number	Amps Per Position	Positions	Main Bus Rating	Line Connector Size	Dimensions		
					D"	W"	H"
U2852-X	125	2	200 Amp	3/8" x 16 Stud*	5 13/16	18	25
U2853-X	125	3	200 Amp	3/8" x 16 Stud*	5 13/16	18	37
U2854-X	125	4	400 Amp	3/8" x 16 Stud*	4 7/8	31	25
U2855-X	125	5	400 Amp	3/8" x 16 Stud*	4 7/8	31	37
U2856-X	125	6	400 Amp	3/8" x 16 Stud*	4 7/8	31	37

## 200 Amps per Position | Multi-Position Sockets | 10K AIC | Ringless

Catalog Number	Amps Per Position	Positions	Main Bus Rating	Line Connector Size	Dimensions		
					D"	W"	H"
U2862-X	200	2	250 Amp	3/8" x 16 Stud*	5 13/16	21	29
U2863-X	200	3	300 Amp	3/8" x 16 Stud*	5 13/16	21	41
U2864-X	200	4	400 Amp	3/8" x 16 Stud*	4 7/8	36	29
U2865-X	200	5	600 Amp	3/8" x 16 Stud*	4 7/8	36	41
U2866-X	200	6	600 Amp	3/8" x 16 Stud*	4 7/8	36	41

### Connector Kits

Size	Suffix	Kit Number	Compatible With	Wire Range
Single	-K1	<b>K1539</b>	U2852-56, U2862-66	#6-350
	-K3	<b>K1540</b>	U2854-56, U2864-66	#4-600
Twin	-K2	<b>K1350</b>	U2854-56, U2863-66	#6-350
	-K4	<b>K1541</b>	U2864-66	#2-600

### Breaker Chart

Manufacturer	150-200 Amps	125 Amps or Less
Milbank	WBJ	—
Cutler Hammer	BR, BJ	Quicklag P, BR, HQP
Siemens	QNR	QP
Siemens/Murray	MD	MP
G.E.	Q Line	Q Line
Square D	—	Homeline

### Notes

- **Connectors:** For line wire connector kits, order separately.
  - **Fifth Terminal:** For field mounted fifth terminal, order catalog number **K2381**. Order one per meter position.
  - **Breakers:** Units have provision for one double pole main per meter position. Breakers not included.
  - **Short Circuit Current Rating:** 10K AIC. However, this rating is limited to the lowest interrupting capacity of any circuit breaker installed. Watthour meter not included in short circuit current rating.
  - **Knockouts:** See next page for drawings and knockout configurations.
- \* To add lugs, see the Connector Kits chart.



Please consult serving utility for their requirements prior to ordering or installing, as specifications and approvals vary by utility, and may require local electrical inspector approval. All installations must be installed by a licensed electrician and must comply with all national and local codes, laws and regulations. Milbank reserves the right to make changes in specifications and features shown without notice or obligation.

# Multi-Position Meter Mains

## Knockout Information

# 27

125/200 AMP  
MULTI-POSITION  
METER MAINS

Catalog Number	Knockouts		
	1	2	3
U2852-X	3	1¼	¼,½
U2853-X	3	1¼	¼,½
U2854-X	3	1¼	¼,½
U2855-X	3	1¼	¼,½
U2856-X	3	1¼	¼,½
U2862-X	3	2	¼,½
U2863-X	3	2	¼,½
U2864-X	3	2	¼,½
U2865-X	3	2	¼,½
U2866-X	3	2	¼,½

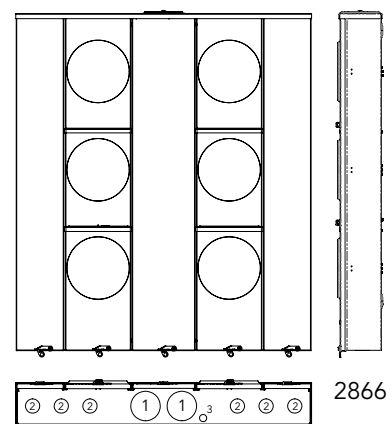
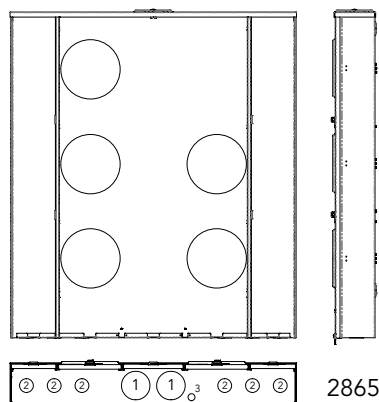
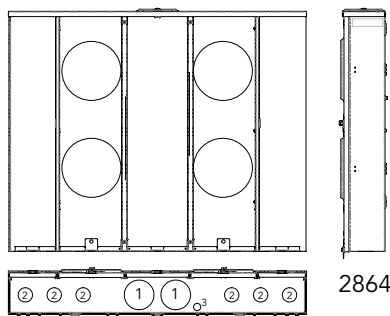
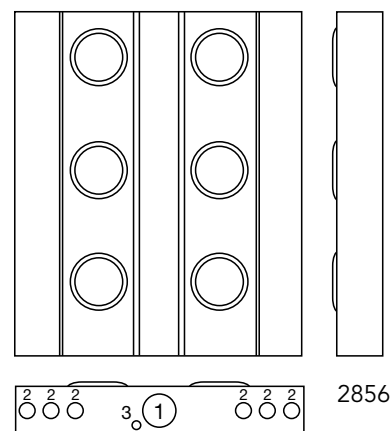
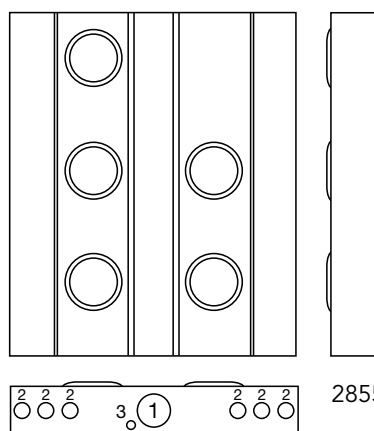
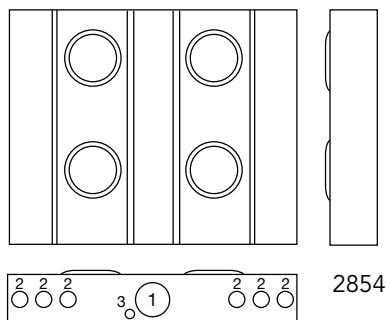
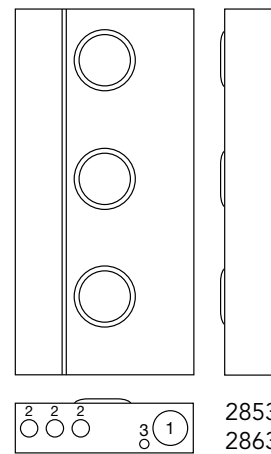
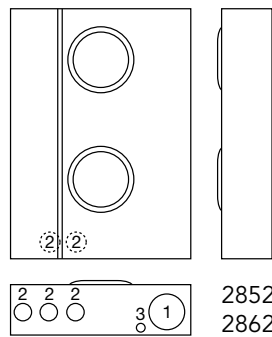

Please consult serving utility for their requirements prior to ordering or installing, as specifications and approvals vary by utility, and may require local electrical inspector approval. All installations must be installed by a licensed electrician and must comply with all national and local codes, laws and regulations. Milbank reserves the right to make changes in specifications and features shown without notice or obligation.



# Multi-Position Meter Mains

125 & 200 Amps | 4 Terminal | Ringless | 120/240 VAC | 22K AIC



U5882-X-KK-BLG



U5884-X-KK-BLG

Rating kAIC	Circuit Breaker 125A
10	SIEMENS: QP CUTLER-HAMMER: BR, HQP, QHP, QPGF SQUARE D: HOMELINE G.E.: (50AMP.MAX.) THQL, THQL-GF
22	SIEMENS: QPH
<b>150-200 AMPS</b>	
10	SIEMENS: QN
22	SIEMENS: QNH

## 125 Amps per Position | 4 Terminal | Multi-Position Meter Main | Ringless

Catalog Number	Amps	Positions	Service	Hub	Connectors CU/AL	Bypass	Dimensions			Weight (lbs.)
					Line		D"	W"	H"	
U5902-X-KK-BLG	125	2	OH/UG	C.P.	3/8" x 16 Stud	Horn	5 1/8"	26 1/2"	30"	58
U5903-X-KK-BLG	125	3	OH/UG	C.P.	3/8" x 16 Stud	Horn	5 1/8"	34 5/8"	30"	88
U5904-X-KK-BLG	125	4	OH/UG	C.P.	3/8" x 16 Stud	Horn	5 1/8"	42 5/8"	30"	107
U5905-X-KK-BLG	125	5	OH/UG	C.P.	3/8" x 16 Stud	Horn	5 1/8"	51 1/20"	30"	128
U5906-X-KK-BLG	125	6	OH/UG	C.P.	3/8" x 16 Stud	Horn	5 1/8"	59 3/10"	30"	146

## 200 Amps per Position | 4 Terminal | Multi Position Meter Main | Ringless

Catalog Number	Amps	Positions	Service	Hub	Connectors CU/AL	Bypass	Dimensions			Weight (lbs.)
					Line		D"	W"	H"	
U5882-X-KK-BLG	200	2	OH/UG	C.P.	3/8" x 16 Stud	Horn	5 1/8"	26 1/2"	30"	58
U5883-X-KK-BLG	200	3	OH/UG	C.P.	3/8" x 16 Stud	Horn	5 1/8"	34 5/8"	30"	88
U5884-X-KK-BLG	200	4	OH/UG	C.P.	3/8" x 16 Stud	Horn	5 1/8"	42 5/8"	30"	107
U5885-X-KK-BLG	200	5	OH/UG	C.P.	3/8" x 16 Stud	Horn	5 1/8"	51 1/20"	30"	128
U5886-X-KK-BLG	200	6	OH/UG	C.P.	3/8" x 16 Stud	Horn	5 1/8"	59 3/10"	30"	146

### Notes

- **Knockouts:** See drawings on the next page.
- **Optional:** Factory installed breakers are available - consult factory.
- **AIC Rating:** All models are rated **22K AIC** when used with approved breakers rated at 22K.
- **Hub:** Units supplied with one (1) closing plate. Order hubs separately, see accessory page.
- **Fifth Terminal:** For field installed fifth terminal, order **K5T**.
- **Connectors:** Socket is supplied with 3/8" - 16 hex head nuts with Belleville washers. For connector lug kits, order as extra from chart on the accessories page. Separate lug kits are required for line and load.



Please consult serving utility for their requirements prior to ordering or installing, as specifications and approvals vary by utility, and may require local electrical inspector approval. All installations must be installed by a licensed electrician and must comply with all national and local codes, laws and regulations. Milbank reserves the right to make changes in specifications and features shown without notice or obligation.

# Multi-Position Meter Mains

## Dimensional Information

# 29

MULTI-POSITION  
METER MAINS

Knockouts				
1	2	3	4	5
3	2½	1	¾	¼

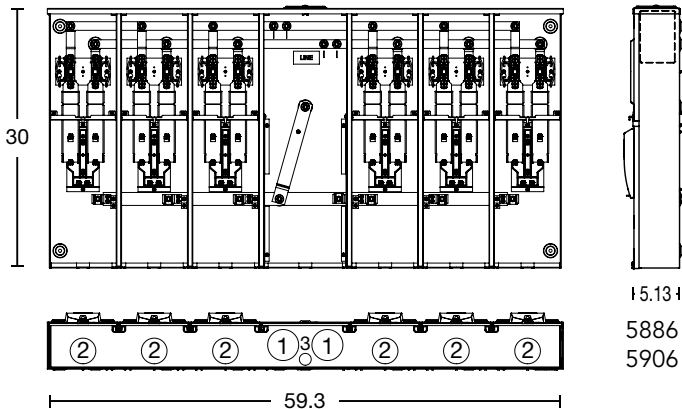
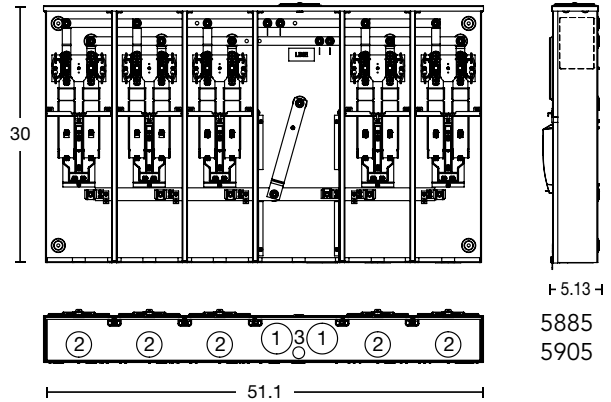
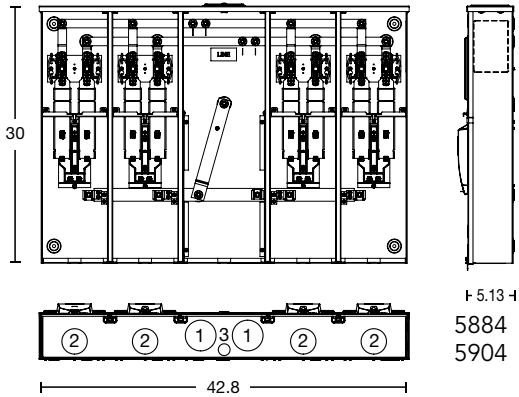
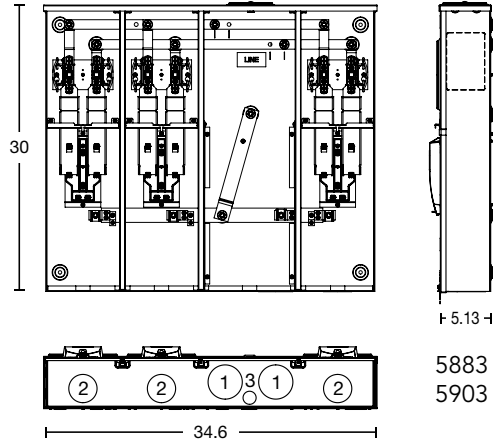
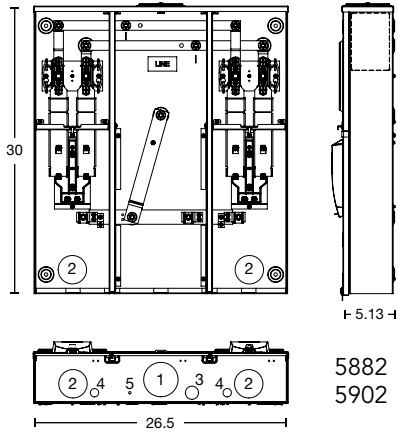

Please consult serving utility for their requirements prior to ordering or installing, as specifications and approvals vary by utility, and may require local electrical inspector approval. All installations must be installed by a licensed electrician and must comply with all national and local codes, laws and regulations. Milbank reserves the right to make changes in specifications and features shown without notice or obligation.





# Transformer Rated

20 Amps | Plunger Bypass | Ringless & Ring Type



UC7235-RL

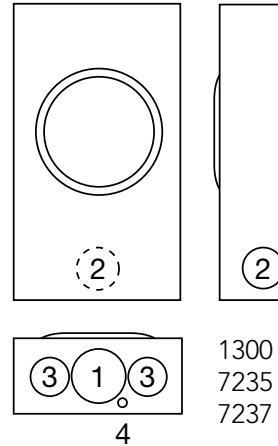

### 1 Piece Cover | Overhead / Underground | Ringless

Catalog Number	Terminals	Type	Hub	Meter Form	Connectors CU	Dimensions			Knockouts			
						D"	W"	H"	1	2	3	4
UC1299-RL	6	Ringless	H.O.	4S	#14-#4 MAX	3 <sup>5</sup> / <sub>16</sub>	8	14	2	1½	1¼	¼
UC7235-RL	8	Ringless	H.O.	5S	#14-#4 MAX	3 <sup>5</sup> / <sub>16</sub>	8	14	2	1½	1¼	¼
UC7237-XL	13	Ringless	C.P.	6, 8, 9	#14-#4 MAX	3 <sup>5</sup> / <sub>16</sub>	8	14	2	1½	1¼	¼

### 1 Piece Cover | Overhead / Underground | Ring Type

Catalog Number	Terminals	Type	Hub	Meter Form	Connectors CU	Dimensions			Knockouts			
						D"	W"	H"	1	2	3	4
UC1300-RL	6	Ring Type	H.O.	4S	#14-#4 MAX	3 <sup>5</sup> / <sub>16</sub>	8	14	2	1½	1¼	¼

### Notes

- **Hubs:** For proper hub selection see the hub suffix chart on the accessory page.

# Transformer Rated

## 20 Amps | Test Switch Provision

**31**  
20 AMPS  
TRANSFORMER  
RATED

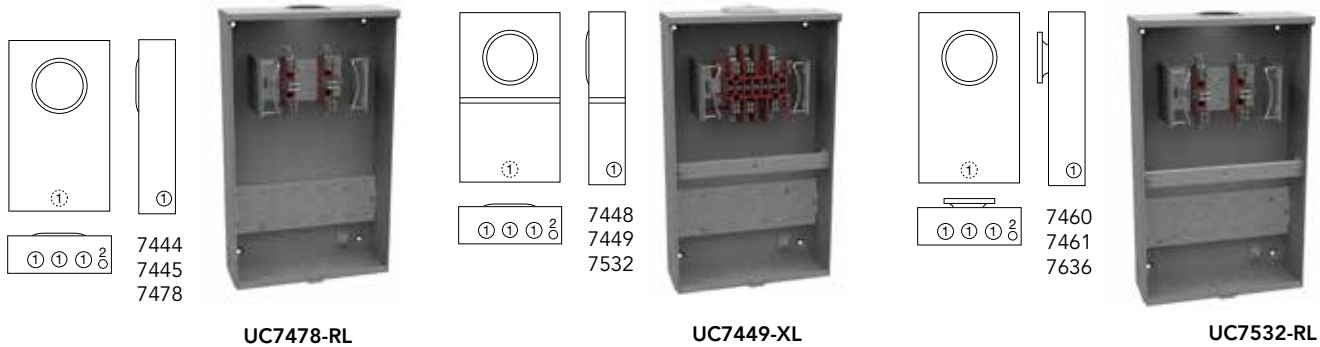

### 1 Piece Cover | Ringless | Overhead / Underground | with test switch provision

Catalog Number	Terminals	Hub	Meter Form	Connectors CU	Bypass	Dimensions			Knockouts	
						D"	W"	H"	1	2
UC7478-RL	6	H.O.	4S	#14 - #4 Max	None	4 $\frac{1}{8}$	12	20	1 $\frac{1}{4}$	$\frac{1}{4}$ , $\frac{1}{2}$
UC7444-RL	8	H.O.	5S	#14 - #4 Max	None	4 $\frac{1}{8}$	12	20	1 $\frac{1}{4}$	$\frac{1}{4}$ , $\frac{1}{2}$
UC7445-RL	13	H.O.	6, 8, 9	#14 - #4 Max	None	4 $\frac{1}{8}$	12	20	1 $\frac{1}{4}$	$\frac{1}{4}$ , $\frac{1}{2}$
UC7445-RL-641*	13	H.O.	6, 8, 9	#14 - #4 Max	None	4 $\frac{1}{8}$	12	20	1 $\frac{1}{4}$	$\frac{1}{4}$ , $\frac{1}{2}$
UC7445-WL	13	1 in	6, 8, 9	#14 - #4 Max	None	4 $\frac{1}{8}$	12	20	1 $\frac{1}{4}$	$\frac{1}{4}$ , $\frac{1}{2}$

\*Pre-wired per Lebanon specifications

### 2 Piece Cover | Ringless | Overhead / Underground | with test switch provision

Ringless Catalog Number	Ring Type Catalog Number	Terminals	Meter Form	Hub	Connectors CU	Dimensions			Knockouts	
						D"	W"	H"	1	2
UC7532-RL	UC7636-RL	6	4S	H.O.	#14 - #4 Max	4 $\frac{1}{8}$	12	20	1 $\frac{1}{4}$	$\frac{1}{4}$ , $\frac{1}{2}$
UC7448-RL	UC7460-RL	8	5S	H.O.	#14 - #4 Max	4 $\frac{1}{8}$	12	20	1 $\frac{1}{4}$	$\frac{1}{4}$ , $\frac{1}{2}$
UC7449-RL	UC7461-RL	13	6, 8, 9	H.O.	#14 - #4 Max	4 $\frac{1}{8}$	12	20	1 $\frac{1}{4}$	$\frac{1}{4}$ , $\frac{1}{2}$

### Notes

- **Hubs:** For proper hub selection see the hub suffix chart on the accessory page.
- **Sealing rings:** Ring type units are supplied with one MR-2, snap type, sealing ring.
- **Pre-wiring:** Factory pre-wiring available.
- **Connectors:** Units are supplied with mechanical type connectors (#4 max). If compression type connectors (#10) are preferred, change catalog prefix to "S" (i.e., UC7445-XL becomes S7445-XL). The "S" prefix also designates non-U/L.

Please consult serving utility for their requirements prior to ordering or installing, as specifications and approvals vary by utility, and may require local electrical inspector approval. All installations must be installed by a licensed electrician and must comply with all national and local codes, laws and regulations. Milbank reserves the right to make changes in specifications and features shown without notice or obligation.



# Lever Bypass Transformer Rated

80 Amps | 6, 8 & 13 Terminal



U4490-XL

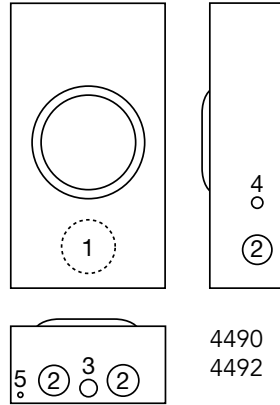

4490  
4492

**80 Amps | Ringless | Transformer Rated | Lever Bypass | No Test Switch Provision**

Catalog Number	Terminals	Service	Hub	Meter Form	Connectors CU	Dimensions			Knockouts				
						D"	W"	H"	1	2	3	4	5
U4490-XL	6	OH/UG	C.P.	4S	#14 - #4 Max	4 <sup>7</sup> / <sub>8</sub>	10	18 <sup>1</sup> / <sub>2</sub>	3	1 <sup>1</sup> / <sub>2</sub>	1 <sup>1</sup> / <sub>2</sub> , <sup>3</sup> / <sub>4</sub>	<sup>3</sup> / <sub>4</sub>	<sup>1</sup> / <sub>4</sub>
U4492-XL	8	OH/UG	C.P.	5S	#14 - #4 Max	4 <sup>7</sup> / <sub>8</sub>	10	18 <sup>1</sup> / <sub>2</sub>	3	1 <sup>1</sup> / <sub>2</sub>	1 <sup>1</sup> / <sub>2</sub> , <sup>3</sup> / <sub>4</sub>	<sup>3</sup> / <sub>4</sub>	<sup>1</sup> / <sub>4</sub>
U4493-XL	13	OH/UG	C.P.	6, 8, 9	#14 - #4 Max	4 <sup>7</sup> / <sub>8</sub>	10	18 <sup>1</sup> / <sub>2</sub>	3	1 <sup>1</sup> / <sub>2</sub>	1 <sup>1</sup> / <sub>2</sub> , <sup>3</sup> / <sub>4</sub>	<sup>3</sup> / <sub>4</sub>	<sup>1</sup> / <sub>4</sub>

## Notes

- **Hubs:** For proper hub selection see the hub suffix chart on the accessory page.
- **Bypass:** Lever operates current bypass device and also supplies clamping action on current meter spades.
- **Connectors:** Units are supplied with mechanical type connectors (#4 max).



Please consult serving utility for their requirements prior to ordering or installing, as specifications and approvals vary by utility, and may require local electrical inspector approval. All installations must be installed by a licensed electrician and must comply with all national and local codes, laws and regulations. Milbank reserves the right to make changes in specifications and features shown without notice or obligation.

# Test Switches

4, 7 & 10 Pole

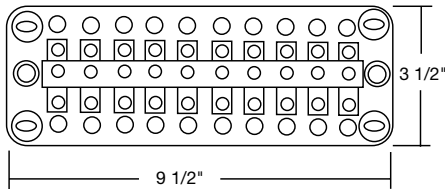
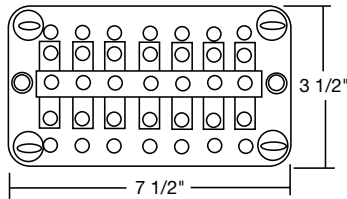
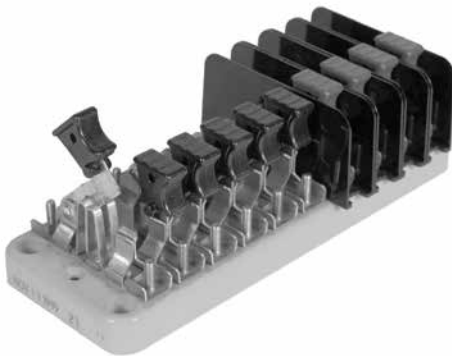

Key	
P	Potential Switch
C+	Line side current switch with short circuit assembly
C	Load side current switch with test jack assembly
N	Neutral bar (no switch)
Pn	Neutral Potential Switch
X	Unused Position on base
	Insulating barrier, isolates both sides of switch

Catalog Number	4-Pole						
TS04-0101	X	P		X	C+	C	X
TS04-0102	X		C+	C	X	Pn	X
TS04-0103	X	P		X	C	C+	X
TS04-0104	X	C+	C	X	P		X

### Notes

- 4-pole switches are also available on 10-pole bases. Contact Milbank for appropriate catalog numbers.

Catalog Number	7-Pole						
TS07-0105		P		C+	C	C+	C
TS07-0106		C+	C		C+	C	
TS07-0107		P		C	C+	C	C+
TS07-0108	C+	C	C+	C		P	

### Notes

- 4-pole switches are also available on 10-pole bases. Contact Milbank for appropriate catalog numbers.

Catalog Number	7-Pole on a 10-Pole Base									
TS07-0049		X		X		X	C+	C	C	C+
TS07-0018		X		X		X	C+	C	C+	C
TS07-0059	X		C+	C		C	C+		X	X
TS07-0022	P	X	P	X	Pn	X	C	C+	C	C+

Catalog Number	10-Pole									
TS10-0109	P		P		C+	C	C+	C	C+	C
TS10-0110		C+	C		C+	C		C+	C	
TS10-0111	P		P		C	C+	C	C+	C	C+
TS10-0112	C+	C	C+	C	C+	C		P		

Please consult serving utility for their requirements prior to ordering or installing, as specifications and approvals vary by utility, and may require local electrical inspector approval. All installations must be installed by a licensed electrician and must comply with all national and local codes, laws and regulations. Milbank reserves the right to make changes in specifications and features shown without notice or obligation.



Electronic version available at [milbankworks.com](http://milbankworks.com)



Customer Name: \_\_\_\_\_

Email: \_\_\_\_\_

Phone: \_\_\_\_\_

Handle Color Key							
BK	Black	P	Purple	Y	Yellow	GN	Green
R	Red	BL	Blue	W	White	BKS	Black Stripe
BR	Brown	GR	Grey	O	Orange	WS	White Stripe

### TEST SWITCH BASE

The base is molded from a high strength, fiberglass reinforced, thermoset polyester. This material is track-resistant, flame-retardant and has low water absorption qualities. Bases are available in two standard sizes following NEMA mounting classifications.

### Pole Position Chart

1	2	3	4	5	6	7	8	9	10

### Special Features

Feature	1	2	3	4	5	6	7	8	9	10
45° Angle Stops										
Ganged Handles (C)										
Bussing										
Colored Handles										

Engineering Information: \_\_\_\_\_

Key	
P	Potential Switch
C+	Line side current switch with short circuit assembly
C	Load side current switch with test jack assembly
N	Neutral bar (no switch)
Pn	Neutral Potential Switch
X	Unused Position on base
L	Insulating barrier (one side)
□	Insulating barrier (two sides)

**Custom Pole Arrangements:** The key may be used to diagram your own pole arrangement. Be sure to specify base size and whether all C+ line side, current switch/shunt circuit assemblies are to be bussed together. The catalog numbers shown above are connected in line-load pairs; therefore, if bussed is required, different catalog numbers will apply.

### Number of Poles

- 4  
 7  
 10  
 Other \_\_\_\_\_

### Test Switch Cover (only available for 10-pole bases)

- Yes | Clear \_\_\_\_ Black \_\_\_\_  
 No

### Base Size

- 7-Pole  
 10-Pole



Please consult serving utility for their requirements prior to ordering or installing, as specifications and approvals vary by utility, and may require local electrical inspector approval. All installations must be installed by a licensed electrician and must comply with all national and local codes, laws and regulations. Milbank reserves the right to make changes in specifications and features shown without notice or obligation.

# Current Transformer Cabinet

Panel Enclosure | Type 3R

**35**  
CURRENT  
TRANSFORMER  
CABINET



304410-CTC3R

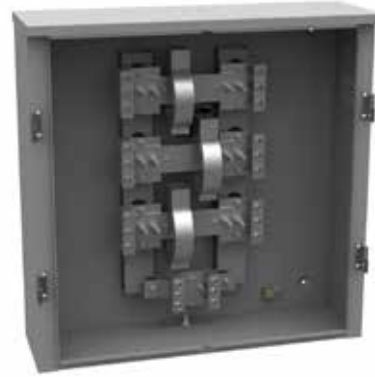

U5990-O

## Outdoor Transformer Cabinets | NEMA 3R

Catalog Number	Dimensions			Gauge of Steel or Aluminum	CT Mounting Provisions	# of Doors	Latching Type	Utility Approval
	D"	W"	H"					
363612-CT3R-SP4	12	36	36	12	Backplate	2	3 Point Latch	LG&E
484814-CT3R-SP1	14	48	48	12	Backplate	2	3 Point Latch	LG&E
323412-SC3R-DUKE	12	32	34	12	CT Plate	1	Hasp	Duke
404014-CT3R-DUKE	14	40	40	12	CT Plate	2	3 Point Latch	Duke
323412-SC3RA-DUKE	12	32	34	.125	CT Plate	1	Hasp	Duke
404014-CT3RA-DUKE	14	40	40	.125	CT Plate	2	3 Point Latch	Duke

## Notes

- **Features:** Supplied with solid back board when noted, three-point locking handle, lift off hinges with stainless steel pins and padlock provisions.
- **U5990-O:** is 3Ø with a 50K RMS rating, and has a wire range of #4-600 kcmil.
- **Approvals:** See utility approval chart on page 63.

Please consult serving utility for their requirements prior to ordering or installing, as specifications and approvals vary by utility, and may require local electrical inspector approval. All installations must be installed by a licensed electrician and must comply with all national and local codes, laws and regulations. Milbank reserves the right to make changes in specifications and features shown without notice or obligation.



# 36

MULTI-POSITION  
TAP BOX

# Multi-Position Tap Box

Three Phase | Aluminum Construction | Wall or Pad Mountable



## Features

- **Painted Aluminum Construction:** Enclosure shells are constructed with lightweight aluminum, making wall-mount installations easier. Powder-coat paint finish helps prevent corrosion.
- **Capable of Wall or Pad Mounting:** Units feature a removable bottom, allowing an easy conversion from a wall-mount to a pad-mount.
- **Smaller Footprint:** The **UAP6094** model has a more compact footprint compared with the leading competitor.
- **Multi-port ground lugs**
- **Optional Pentabolt Secured Handle available** (see pics below): Enclosure handle can be included with an optional pentabolt locking mechanism (see photos below) for enhanced protection.



## Common Applications



Catalog Number	Phase	Position Lugs	Maximum Wire Size	Maximum Amperage	Dimensions		
					D"	W"	H"
UAP6094-O	3	16	500 kcmil	3000 Amps	16	25 $\frac{5}{8}$	43
UAP6095-O	3	22	500 kcmil	4000 Amps	16	32 $\frac{5}{8}$	43
UAP6096-O	3	14	750 kcmil	3300 Amps	16	25 $\frac{15}{16}$	51

Stainless steel pad mount spacing brackets included



Please consult serving utility for their requirements prior to ordering or installing, as specifications and approvals vary by utility, and may require local electrical inspector approval. All installations must be installed by a licensed electrician and must comply with all national and local codes, laws and regulations. Milbank reserves the right to make changes in specifications and features shown without notice or obligation.



# Multi-Position Tap Box

## Line Drawings

37

LINE DRAWINGS

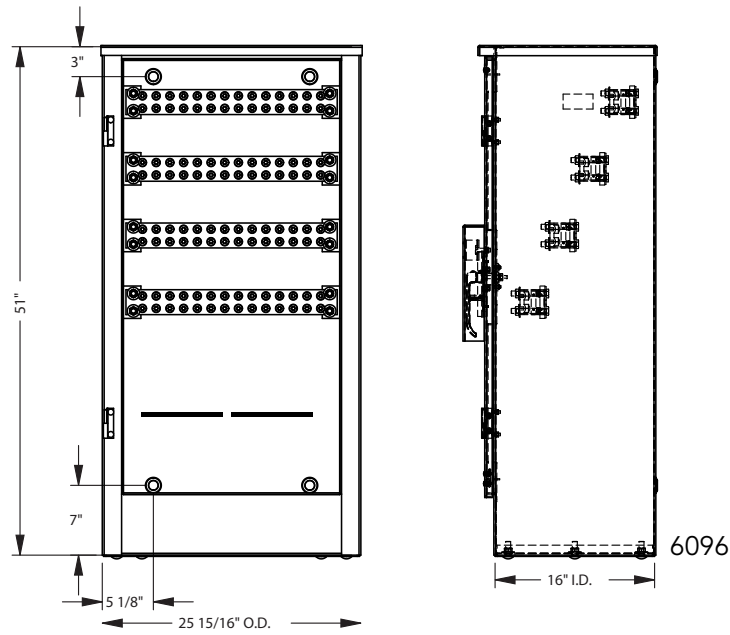
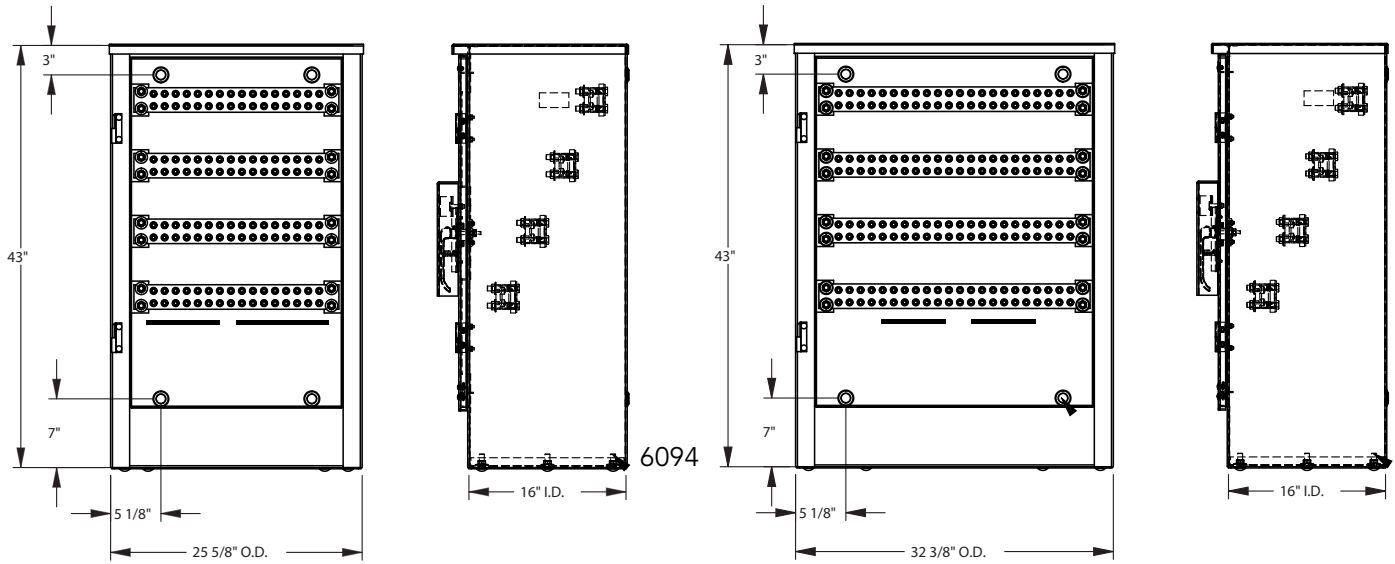

Please consult serving utility for their requirements prior to ordering or installing, as specifications and approvals vary by utility, and may require local electrical inspector approval. All installations must be installed by a licensed electrician and must comply with all national and local codes, laws and regulations. Milbank reserves the right to make changes in specifications and features shown without notice or obligation.



# 38

100-200 AMPS  
METER MAIN WITH  
LOAD CENTER  
PEDESTAL

# Meter Main w/ Load Center Pedestal

100-200 Amps | 4 Terminal | Ringless | 120/240 VAC



U5136-O-200S

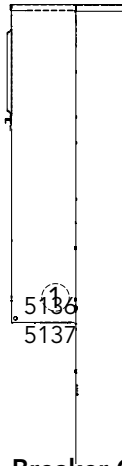

U6220-O-200-KK-10GR

### Breaker Chart U5136 & U5137

Rating kAIC	Large Frame Main Breaker	Small Frame Branch Breakers
10	UQFP-M	SIEMENS: QP, QT CUTLER-HAMMER: QP, BD, BR; G.E.: TQ, THQ, THQL SQUARE D: HOM115, HOM2100
22	UQFPH-M	QPH

### Breaker Chart U6220

AIC Rating	Amps	Siemens	Cutler Hammer	General Electric	Square D
10k	150-200	QNR	BR (150A only)	—	—
	≤ 125	QP	HQP, BR	THQL, THQL-GF	Homeline
22k	150-200	QNRH	—	—	—
	≤ 125	QPH	—	—	—

### 100-200 Amps | 4 Terminal | Meter Main Pedestal | Ringless

Catalog Number	Breaker Amps	Service	Powerheads	Branch Circuits	Bypass	Connectors CU/AL		Knockouts		
						Line	Load	1	2	3
U5136-O	Provision	UG	Single	4	Horn	#6-350	CB	2	1/2, 3/4	1/4
U5136-O-100S	100	UG	Single	4	Horn	#6-350	CB	2	1/2, 3/4	1/4
U5136-O-200S	200	UG	Single	4	Horn	#6-350	CB	2	1/2, 3/4	1/4
U5137-O-200S	200	UG	Double	4	Horn	#6-350	CB	2	1/2, 3/4	1/4

### 100-200 Amps | 4 Terminal | Meter Main Pedestal | Ringless

Catalog Number	Breaker Amps	Service	Powerheads	Branch Circuits	Bypass	Connectors CU/AL		Knockouts		
						Line	Load	1	2	3
U6220-O-100-KK-10GR	100	UG	Single	10	Horn	#6-350	#6-350	2	1/2, 3/4	1/4
U6220-O-200-KK-10GR	200	UG	Single	8	Horn	#6-350	#6-350	2	1/2, 3/4	1/4

### Notes

- **Parallel to series conversion:** For field converting from parallel wired to series wired order **K5194**.
- **Fifth terminal:** For field installed fifth terminal, order **K5T**.
- **Stabilizer foot:** For field installed stabilizer foot, order **K5415**.
- **Penta bolt locking:** For field installed pedestal fronts penta bolt locking, order **K5039**.
- **Receptacles:** Consult factory for installed receptacle assemblies.
- **Short circuit current rating:** 22K AIC. However, this rating is limited to the lowest interrupting capacity of any circuit breaker installed. Watthour meter not included in short circuit current rating.
- Receptacle Bridge is ordered separately on part# **K5400-BRIDGE-2POS**.
- Contact factory for receptacle configurations available.
- Pedestals with -10GR suffix include a 20 Amps GFI receptacle.



Please consult serving utility for their requirements prior to ordering or installing, as specifications and approvals vary by utility, and may require local electrical inspector approval. All installations must be installed by a licensed electrician and must comply with all national and local codes, laws and regulations. Milbank reserves the right to make changes in specifications and features shown without notice or obligation.

# Meter Main Pedestal

320 Amps | 4 Terminal | Ringless | 120/240 VAC

**39**  
320 AMPS  
METER MAIN  
PEDESTAL



U3849-O-2/200

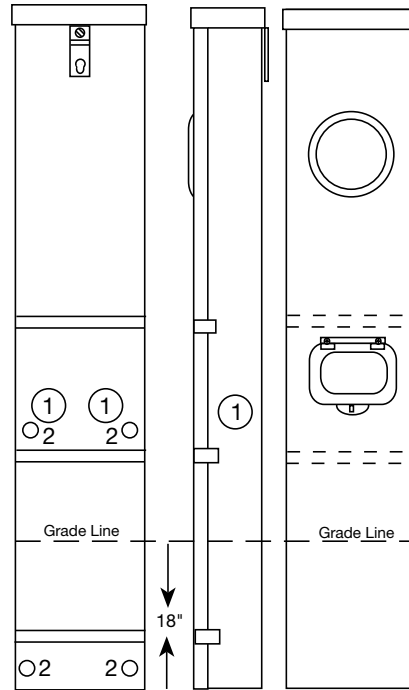

## 320 Amps | 4 Terminal | Meter Main Pedestal | Ringless | 120/240 VAC

Catalog Number	Service	Hub	Bypass	Connectors CU/AL		Dimensions			Knockouts		
				Line	Load	D"	W"	H"	1	2	3
U3849-O-2/200	UG	Blank	Lever	3/8" x 16 Stud	1/0-300	4 7/8	13	64	2	1/2, 3/4	1/4

### Notes

- **Breakers:** Supplied from factory with 2 double-pole, Milbank **UQFB** or **UQFBH** (22K AIC) bolt-on circuit breakers.
- **Connectors:** The line wire section is supplied with 3/8"-16 studs with hex nuts and captive Bellville washers. For line side connectors, order as extra catalog numbers **K1539** (single-350 kcmil), or **K1540** (single-600 kcmil), or for twin **K1350** (twin 350 kcmil). Order one kit per unit.
- **Extension kit:** For extension kit, order as extra catalog number **S1848**.
- **Bypass:** Lever supplies clamping action on meter spades and also operates bypass device.
- **Short circuit current rating:** These units are rated 22K AIC. However, this rating is limited to the lowest interrupting capacity of any circuit breaker installed. Watthour meter not included in short circuit current rating.

Please consult serving utility for their requirements prior to ordering or installing, as specifications and approvals vary by utility, and may require local electrical inspector approval. All installations must be installed by a licensed electrician and must comply with all national and local codes, laws and regulations. Milbank reserves the right to make changes in specifications and features shown without notice or obligation.



# Meter Socket Pedestal

320 Amps | 4 Terminal | Ringless | 120/240 VAC



U1748-O

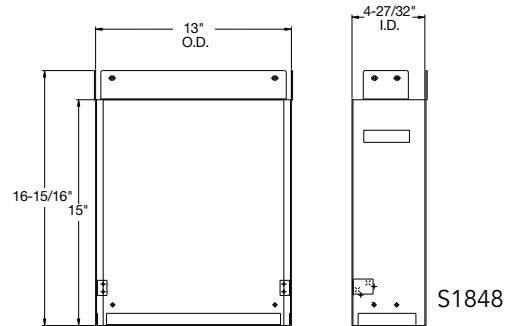
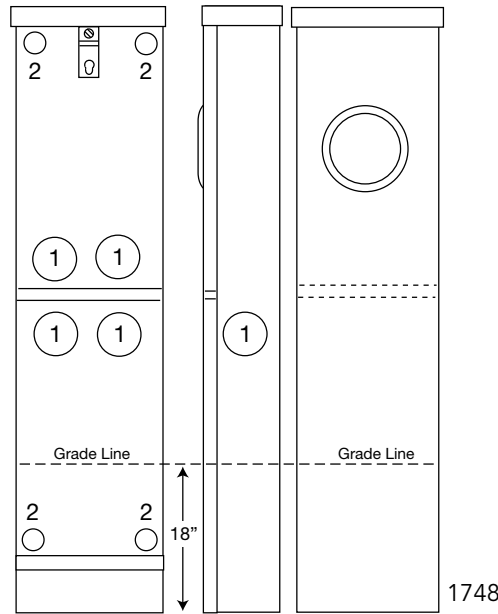

320 Amps | Ringless | 600 VAC

Catalog Number	Service	Hub	Bypass	Connectors CU/AL		Dimensions			Knockouts	
				Line	Load	D"	W"	H"	1	2
U1748-O	UG	Blank	Lever	#6-350	(2)#6-350	4 <sup>7</sup> / <sub>8</sub>	13	64	2 1/2	5/16

**Notes**

- **Connectors:** On the U1748-O the connectors K1539 (single-350 kcmil) are factory installed on the line side. Load side is furnished with K1350 (twin-350 kcmil).
- **Extension kit:** For extension kit, order as extra catalog number S1848.
- **Bypass:** Lever supplies clamping action on meter spades and also operates bypass device.
- **Hanging hook:** Units supplied with hanger hooks for easy mounting.
- **Short circuit current rating:** These units are rated 22K AIC. Watthour meter not included in short circuit current rating.



Please consult serving utility for their requirements prior to ordering or installing, as specifications and approvals vary by utility, and may require local electrical inspector approval. All installations must be installed by a licensed electrician and must comply with all national and local codes, laws and regulations. Milbank reserves the right to make changes in specifications and features shown without notice or obligation.

# Device Plates

U5136 & U5137

		
<b>K5935-41</b>	<b>K5935-10GR</b>	<b>K5935-11GR</b>
		
<b>K5935-36GR</b>	<b>K5935-54</b>	<b>K5935-2/1450</b>
		
<b>K5400-BRIDGE-2POS</b>		

Please consult serving utility for their requirements prior to ordering or installing, as specifications and approvals vary by utility, and may require local electrical inspector approval. All installations must be installed by a licensed electrician and must comply with all national and local codes, laws and regulations. Milbank reserves the right to make changes in specifications and features shown without notice or obligation.



# Temporary Power Units

125 Amps | 4 Terminal | Ringless | 120/240 VAC



U5101-XL-11GR

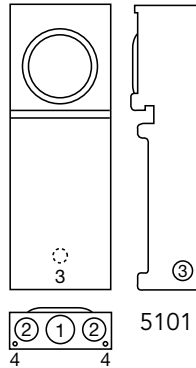

U4908-O-11GR

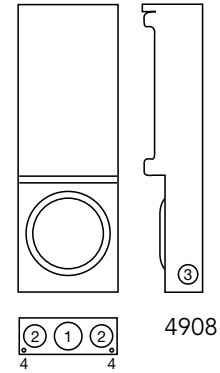

## 125 Amps | 4 Terminal | Temporary Power Units | Ringless | 1Ø3W

Catalog Number	Service	Hub	Connectors CU/AL		Dimensions			Knockouts				
			Line	Load	D"	W"	H"	1	2	3	4	5
U5101-XL-11GR	OH	C.P.	#6-350	#6-350	5 <sup>3</sup> / <sub>16</sub>	8 <sup>7</sup> / <sub>8</sub>	25	2	1 <sup>1</sup> / <sub>2</sub>	1 <sup>1</sup> / <sub>4</sub>	1 <sup>1</sup> / <sub>4</sub>	—
U4908-O-11GR	UG	Blank	#6-2/0	#6-2/0	5 <sup>3</sup> / <sub>16</sub>	9	25 <sup>15</sup> / <sub>16</sub>	2	1 <sup>1</sup> / <sub>2</sub>	1 <sup>1</sup> / <sub>4</sub>	1 <sup>1</sup> / <sub>4</sub>	—

### Notes

- **Interior:** Six circuit plated copper interior accepts standard plug-in type circuit breakers.
- **Receptacle bridge:** Three position self-grounded receptacle bridge accepts most standard NEMA receptacles with mounting plates.
- **Included parts:** U4908 and U5101 come supplied with 2-20 Amps single pole breakers and 2-20 Amps GFCI receptacles installed and pre-wired.



Please consult serving utility for their requirements prior to ordering or installing, as specifications and approvals vary by utility, and may require local electrical inspector approval. All installations must be installed by a licensed electrician and must comply with all national and local codes, laws and regulations. Milbank reserves the right to make changes in specifications and features shown without notice or obligation.

# Surface Mount Power Outlet

Millennium Series | Metered & Unmetered | 120/240 VAC

**43**  
125 AMPS  
SURFACE  
MOUNT POWER  
OUTLET

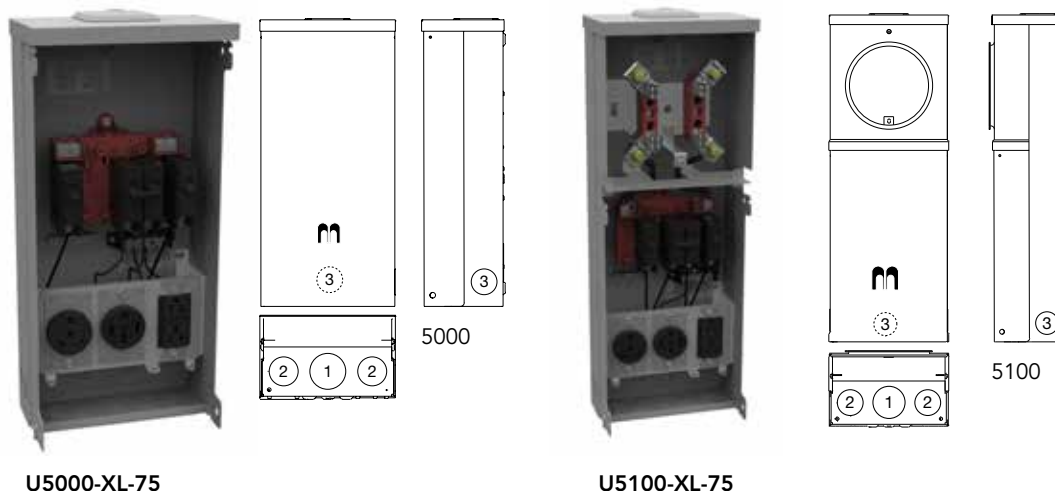

U5000-XL-75

U5100-XL-75

## 125 Amps | Surface Mount Power Outlets | Ring-Type

Catalog Number	Metered/Unmetered	Receptacle Configuration	Circuit Breaker Configuration	Loop Feed	Connectors - Line	Dimensions			Knockouts		
						D"	W"	H"	1	2	3
U5000-XL*	Unmetered	—	—	Yes	(2) 1/0-#12	5½	9⅞	19¼	2	1½	1¼
U5000-XL-41	Unmetered	A	X	Yes	(2) 1/0-#12	5½	9⅞	19¼	2	1½	1¼
U5000-XL-55	Unmetered	B	Y	Yes	(2) 1/0-#12	5½	9⅞	19¼	2	1½	1¼
U5000-XL-75	Unmetered	C	Z	Yes	(2) 1/0-#12	5½	9⅞	19¼	2	1½	1¼
U5100-XL*	Metered	—	—	No	#6-250	5½	9⅞	25	2	1½	1¼
U5100-XL-41	Metered	A	X	No	#6-250	5½	9⅞	25	2	1½	1¼
U5100-XL-55	Metered	B	Y	No	#6-250	5½	9⅞	25	2	1½	1¼
U5100-XL-75	Metered	C	Z	No	#6-250	5½	9⅞	25	2	1½	1¼

\* Comes with circuit breaker bridge

For easy read meter see the accessory pages for **CL200** analog or **CL200-D** digital meter.

### Receptacle Configurations

A	B	C
(1) TT30R, (1) 5-20R GFI	(1) 14-50R, (1) 5-20R GFI	(1) 14-50R, (1) TT30R, (1) 5-20R GFI

### Circuit Breaker Configurations

X	Y	Z
(1) 30A, 1P, 120V (1) 20A, 1P, 120V	(1) 50A, 2P, 120/240V (1) 20A, 1P, 120V	(1) 50A, 2P, 120/240V (1) 30A, 1P, 120V (1) 20A, 1P, 120V

**NOTE**  
Contact factory for additional configurations not shown here.

Please consult serving utility for their requirements prior to ordering or installing, as specifications and approvals vary by utility, and may require local electrical inspector approval. All installations must be installed by a licensed electrician and must comply with all national and local codes, laws and regulations. Milbank reserves the right to make changes in specifications and features shown without notice or obligation.







U5200-XL-75

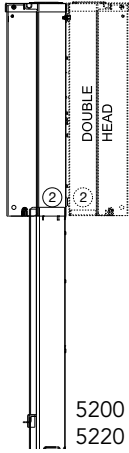
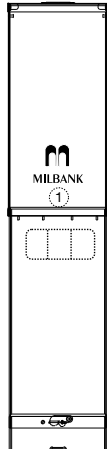

5200  
5220

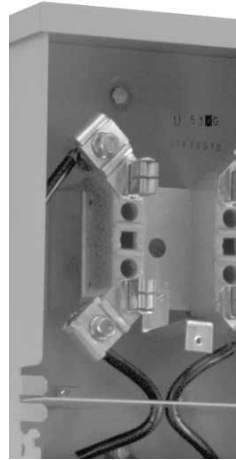

U5300-O-75

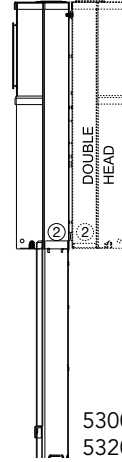
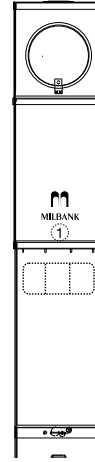

5300  
5320

### 125 Amps | Power Outlet Pedestals | Direct Burial | Ring-Type

Catalog Number	Double Head Catalog Number	Metered/ Unmetered	Receptacle Configuration	Circuit Breaker Configuration	Dimensions			Knockout
					D"	W"	H"	1
U5200-XL*	U5220-XL	Unmetered	—	—	5 <sup>5</sup> / <sub>16</sub>	9 <sup>1</sup> / <sub>8</sub>	64 <sup>1</sup> / <sub>2</sub>	1 <sup>1</sup> / <sub>4</sub>
U5200-XL-41	U5220-XL-41	Unmetered	A	X	5 <sup>5</sup> / <sub>16</sub>	9 <sup>1</sup> / <sub>8</sub>	64 <sup>1</sup> / <sub>2</sub>	1 <sup>1</sup> / <sub>4</sub>
U5200-XL-55	U5220-XL-55	Unmetered	B	Y	5 <sup>5</sup> / <sub>16</sub>	9 <sup>1</sup> / <sub>8</sub>	64 <sup>1</sup> / <sub>2</sub>	1 <sup>1</sup> / <sub>4</sub>
U5200-XL-75	U5220-XL-75	Unmetered	C	Z	5 <sup>5</sup> / <sub>16</sub>	9 <sup>1</sup> / <sub>8</sub>	64 <sup>1</sup> / <sub>2</sub>	1 <sup>1</sup> / <sub>4</sub>
U5300-O*	U5320-O	Metered	—	—	5 <sup>5</sup> / <sub>16</sub>	9 <sup>1</sup> / <sub>8</sub>	70 <sup>1</sup> / <sub>4</sub>	1 <sup>1</sup> / <sub>4</sub>
U5300-O-41	U5320-O-41	Metered	A	X	5 <sup>5</sup> / <sub>16</sub>	9 <sup>1</sup> / <sub>8</sub>	70 <sup>1</sup> / <sub>4</sub>	1 <sup>1</sup> / <sub>4</sub>
U5300-O-55	U5320-O-55	Metered	B	Y	5 <sup>5</sup> / <sub>16</sub>	9 <sup>1</sup> / <sub>8</sub>	70 <sup>1</sup> / <sub>4</sub>	1 <sup>1</sup> / <sub>4</sub>
U5300-O-75	U5320-O-75	Metered	C	Z	5 <sup>5</sup> / <sub>16</sub>	9 <sup>1</sup> / <sub>8</sub>	70 <sup>1</sup> / <sub>4</sub>	1 <sup>1</sup> / <sub>4</sub>

### Receptacle Configurations

A	B	C
(1) TT30R, (1) 5-20R GFI	(1) 14-50R, (1) 5-20R GFI	(1) 14-50R, (1) TT30R, (1) 5-20R GFI

\*Circuit Breaker Bridge included

### Circuit Breaker Configurations

X	Y	Z
(1) 30A, 1P, 120V (1) 20A, 1P, 120V	(1) 50A, 2P, 120/240V (1) 20A, 1P, 120V	(1) 50A, 2P, 120/240V (1) 30A, 1P, 120V (1) 20A, 1P, 120V

**NOTE**  
Contact factory for additional configurations not shown here.  
Pad mount is available - contact factory for information.



Please consult serving utility for their requirements prior to ordering or installing, as specifications and approvals vary by utility, and may require local electrical inspector approval. All installations must be installed by a licensed electrician and must comply with all national and local codes, laws and regulations. Milbank reserves the right to make changes in specifications and features shown without notice or obligation.

# Replacement Receptacle Plates

For Millennium Series Products

**45**  
REPLACEMENT  
RECEPTACLE  
PLATES

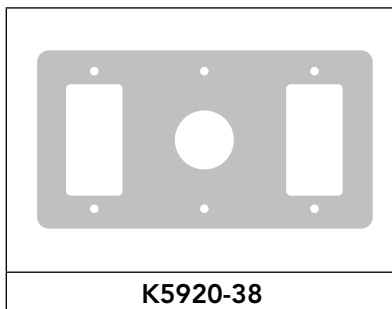
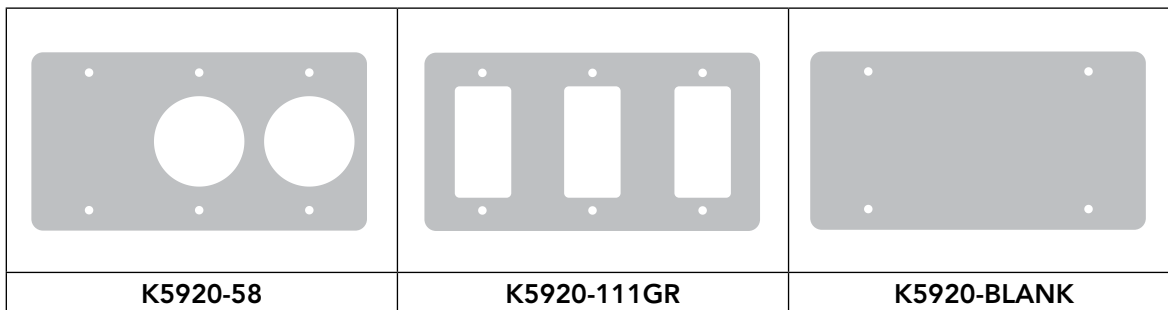
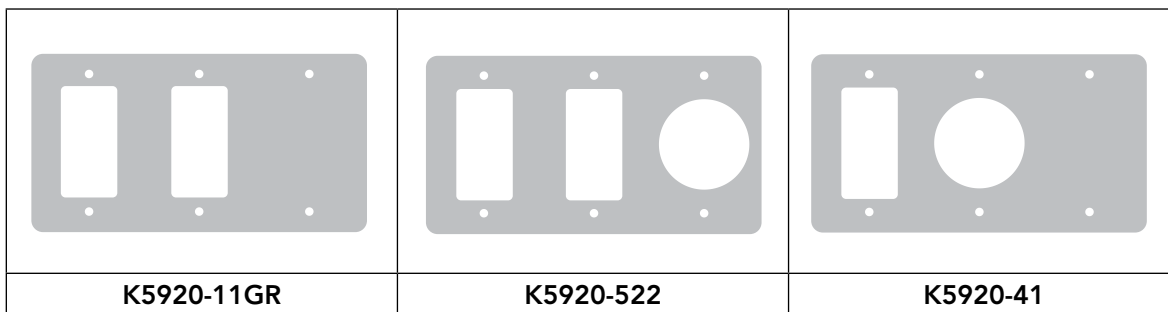
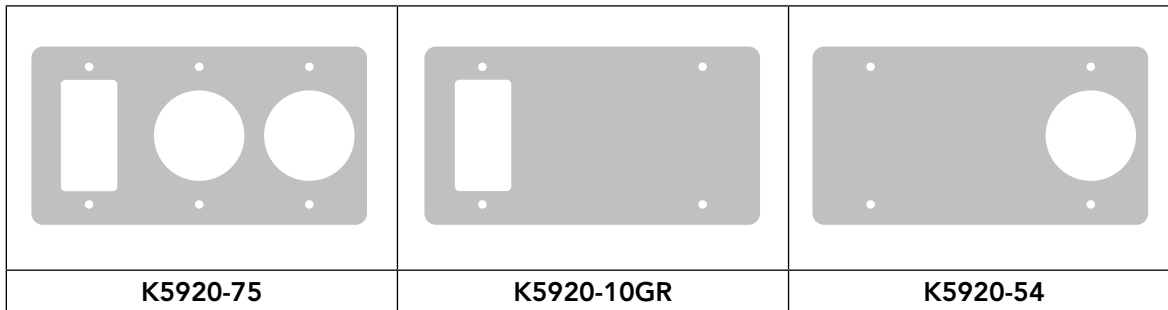

## Notes

- For application details, consult factory.

Please consult serving utility for their requirements prior to ordering or installing, as specifications and approvals vary by utility, and may require local electrical inspector approval. All installations must be installed by a licensed electrician and must comply with all national and local codes, laws and regulations. Milbank reserves the right to make changes in specifications and features shown without notice or obligation.



### Internal LED Light Kits for Unmetered Power Outlets (U5000 & U5200)

<b>Application</b>	Internal light kit for unmetered power outlets	
<b>LED Features</b>	Includes new LED light, lamp shield and opaque hinge cover lens. Factory wired to 20 Amps GFI circuit. May be wired to separate 20 Amps circuit breaker. Order Q120 separately.  Cover on unmetered power outlet is 19 1/8" in height.	
<b>Ordering</b>	Order with -LD suffix (after catalog number) for factory installed.  Order catalog number K6212 for field installed.	

### Internal Florescent Light Kits for Unmetered Power Outlets (U5000 & U5200)

<b>Application</b>	Internal light kit for unmetered power outlets	
<b>Fluorescent Features</b>	Includes 5-watt fluorescent lamp socket, ballast, lamp shield and opaque hinge cover lens. Factory wired to 20 Amps GFI circuit. May be wired to separate 20 Amps circuit breaker. Order Q120 separately.  Cover on unmetered power outlet is 19 1/8" in height.	
<b>Ordering</b>	Order with -L suffix (after catalog number) for factory installed.  Order catalog number K5411 for field installed.	

### Photoelectric Light Control Kit

<b>Application</b>	Photoelectric light control kit for K5411 light kits.	
<b>Features</b>	2.5 Amps, 120 volt photo electrical control wired in series with K5411 light kits.	
<b>Ordering</b>	Order with -LPC suffix for factory installed light and PE control.  Order catalog number K5413 for field installed.	

**WARNING!**

Always disconnect power prior to installing these devices.

# Lighting Accessories

For Millennium Series Products

## Internal Light Kits for Metered Power Outlets (U5100 & U5300)

<b>Application</b>	Internal light kit for metered power outlets	
<b>LED Features</b>	Includes new LED light, lamp shield and opaque hinge cover lens. Factory wired to 20 Amps GFI circuit. May be wired to separate 20 Amps circuit breaker. Order Q120 separately.  Cover on metered power outlet is 15¼" in height.	
<b>Ordering</b>	Order with -LD suffix (after catalog number) for factory installed.  Order catalog number K6213 for field installed.	

<b>Application</b>	Internal light kit for metered power outlets	
<b>Fluorescent Features</b>	Includes 5-watt fluorescent lamp socket, ballast, lamp shield and opaque hinge cover lens. Factory wired to 20 Amps GFI circuit. May be wired to separate 20 Amps circuit breaker. Order Q120 separately.  Cover on metered power outlet is 15¼" in height.	
<b>Ordering</b>	Order with -L suffix (after catalog number) for factory installed.  Order catalog number K5412 for field installed.	

## Photoelectric Light Control Kit

<b>Application</b>	Photoelectric light control kit for K5412 light kits.	
<b>Features</b>	2.5 Amps, 120 volt photo electrical control wired in series with K5412 light kits.	
<b>Ordering</b>	Order with -LPC suffix for factory installed light and PE control.  Order catalog number K5413 for field installed.	

**WARNING!**

Always disconnect power prior to installing these devices.

Please consult serving utility for their requirements prior to ordering or installing, as specifications and approvals vary by utility, and may require local electrical inspector approval. All installations must be installed by a licensed electrician and must comply with all national and local codes, laws and regulations. Milbank reserves the right to make changes in specifications and features shown without notice or obligation.



## Telephone and Cable TV Kit

<b>Application</b>	Mounts to rear of pedestal series <b>U5200</b> and <b>U5300</b> . May also be adaptable to a wooden or similar structure.	 <b>K4709-02-3R</b> <b>K4709-02</b>
<b>Features</b>	<p>Single: 16" galvanized raceway, (1) RJ11 telephone jack and (1) Type F coaxial CATV jack.</p> <p>Dual: 16" galvanized raceway, (2) RJ11 telephone jacks and (1) Type F coaxial CATV jack.</p> <p>Includes mounting hardware and instructions.</p>	
<b>Ordering</b>	Single line telephone and cable TV kit order <b>K4709-02</b> .	
<b>Note</b>	Confirm acceptability with Cable TV and Telephone provider before ordering or installing these devices.	

## Water Shroud with Hardware

<b>Application</b>	Used to cover water pipe and provide means to mount hose bib to rear of pedestal.	
<b>Features</b>	<p>Includes mounting hardware and instructions.</p> <p>Matches <b>K4709</b> kits when mounted side-by-side.</p>	
<b>Ordering</b>	Order catalog number <b>K4709-WS</b> .	

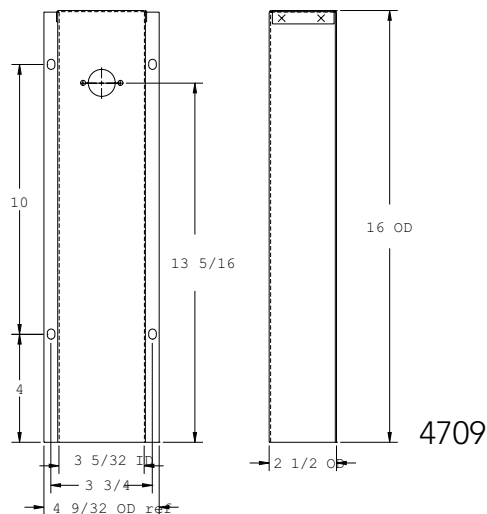

Please consult serving utility for their requirements prior to ordering or installing, as specifications and approvals vary by utility, and may require local electrical inspector approval. All installations must be installed by a licensed electrician and must comply with all national and local codes, laws and regulations. Milbank reserves the right to make changes in specifications and features shown without notice or obligation.

# Pedestal Mounting Accessories

For Millennium Series Products

## Field-Installed Pad Mount Kit

<b>Application</b>	Field installed pad mount kit with (6) 3/4" mounting holes.	
<b>Features</b>	Includes 1/4-20 stainless steel hardware to attach pad mount base to post.  Anchor bolt kit sold separately (order catalog number <b>K5421</b> ).	
<b>Ordering</b>	Order catalog number <b>K5410</b> .	

## Stabilizer Foot with Hardware

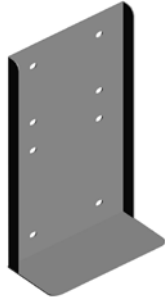
<b>Application</b>	Stabilizes direct burial type posts in unstable soil conditions.	
<b>Features</b>	Includes 1/4-20 hardware to attach to <b>U5200</b> and <b>U5300</b> pedestals.	
<b>Ordering</b>	Order catalog number <b>K5415</b> .	

## Anchor Bolt Kit

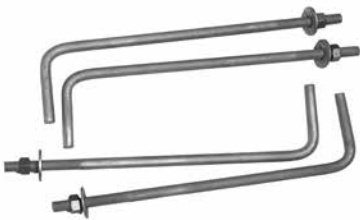
<b>Application</b>	Concrete anchor bolt kit designed to attach pad mount base to concrete.	
<b>Features</b>	(4) sets of zinc-plated 5/8-11 x 10" bolt with 2" toe.  Includes nut and flat washer.	
<b>Ordering</b>	Order catalog number <b>K5421</b> .	

Please consult serving utility for their requirements prior to ordering or installing, as specifications and approvals vary by utility, and may require local electrical inspector approval. All installations must be installed by a licensed electrician and must comply with all national and local codes, laws and regulations. Milbank reserves the right to make changes in specifications and features shown without notice or obligation.







## Field-Installed Meter Kits

<b>Application</b>	Field installed meter kit for <b>U5000</b> and <b>U5200</b> power outlets.	 <b>K4800-D</b>
<b>Features</b>	100 Amps cast meter socket, <b>CL200D</b> E-Z Read Meter, sealing ring, security seal, 1" Milbank hub, nipple and mounting screws.  See <b>CL200D</b> for Watt-hour meter specification.	
<b>Ordering</b>	Order catalog number <b>K4800-01D</b> mechanical meter kit, or <b>K4800-D</b> digital meter kit.	

## E-Z Read Watt-Hour Meter

<b>Application</b>	200 Amps E-Z read watt-hour meter designed to be field installed on the <b>U5100</b> and <b>U5300</b> metered power outlets.	 <b>CL200-D</b> Digital
<b>Features</b>	200 Amps form 2S 120/240 volt.  Numeric readout in full kilowatt increments. No "tenths" dial; digital readout option available.  Remanufactured within 1% accuracy.	
<b>Ordering</b>	Order catalog number <b>CL200-D</b> .	

## Single Receptacle Only Power Outlet

<b>Application</b>	Overhead/underground power outlet receptacle, suitable for RV, temporary service, campground, marina and boatyard equipment.			
<b>Features</b>	Type 3R, 120/240 volt single phase.  Lockable cover.  Breaker not included (in receptacle box).			
<b>Ordering</b>	Order catalog number from chart below.			
<b>Receptacle Options</b>	 <b>P-10GWR</b> 20A 5-20GR 120V GFI	 <b>P-13</b> 30A TT-30R 120V	 <b>P-54</b> 50A 14-50R 120/240V	

### WARNING!





Always disconnect power prior to installing these devices.





# Replacement Parts & Accessories

For Millennium Series Products

**51**  
REPLACEMENT  
PARTS &  
ACCESSORIES

			
<b>Q120</b> 20 Amps, 1 pole circuit breaker	<b>708784-MO</b> 20 Amps, 1 pole GFI circuit breaker	<b>Q130</b> 30 Amps, 1 pole circuit breaker	<b>Q250</b> 50 Amps, 2 pole circuit breaker

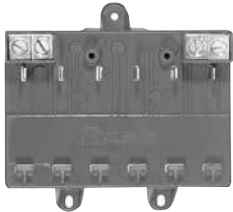
Main Breaker Kit Part number	Metered/Unmetered Surface Mount/ Pedestal	Amp
<b>K5400-100MBM</b>	Metered	100
<b>K5400-100MBU</b>	Unmetered	100

		
<b>Z918466-AC</b> Lug landing base	<b>Z917602-AC</b> Circuit breaker base (6-circuit)	<b>Z915141-AC</b> Left or right meter block assembly

Please consult serving utility for their requirements prior to ordering or installing, as specifications and approvals vary by utility, and may require local electrical inspector approval. All installations must be installed by a licensed electrician and must comply with all national and local codes, laws and regulations. Milbank reserves the right to make changes in specifications and features shown without notice or obligation.





**UQFP  
UQFPH**



**UQFP-M  
UQFPH-M**



**UQFB-X1**



**UQFBH**

### 200 Amps Frame | Plug-In | 10,000 AIC & 22,000 AIC | Two-Pole - Common Trip

Amps	10K AIC Plug-In	22K AIC Plug-In	10K AIC Plug-In	22K AIC Plug-In	Wire Range	
					CU	AL
100	UQFP-100	UQFPH-100	UQFP-M-100	UQFPH-M-100	#3-#1	#1-1/0
125	UQFP-125	UQFPH-125	UQFP-M-125	UQFPH-M-125	#3-#1	#1-1/0
150	UQFP-150	UQFPH-150	UQFP-M-150	UQFPH-M-150	1/0-300	2/0-300
175	UQFP-175	UQFPH-175	UQFP-M-175	UQFPH-M-175	1/0-300	2/0-300
200	UQFP-200	UQFPH-200	UQFP-M-200	UQFPH-M-200	1/0-300	2/0-300

### 200 Amps Frame | Bolt-On | 10,000 AIC & 22,000 AIC | Two-Pole - Common Trip

Amps	10K AIC Bolt-On	22K AIC Bolt-On	10K AIC Bolt-On	22K AIC Bolt-On	Wire Range	
					CU	AL
100	UQFB-100	UQFBH-100	UQFB-100-X1	UQFBH-M-100	#3-#1	#1-1/0
125	UQFB-125	UQFBH-125	UQFB-125-X1	UQFBH-M-125	#3-#1	#1-1/0
150	UQFB-150	UQFBH-150	UQFB-150-X1	UQFBH-M-150	1/0-300	2/0-300
175	UQFB-175	UQFBH-175	UQFB-175-X1	UQFBH-M-175	1/0-300	2/0-300
200	UQFB-200	UQFBH-200	UQFB-200-X1	UQFBH-M-200	1/0-300	2/0-300

### Notes

- **UL listed:** For use with 60°C or 75°C wire.
- **UQFP:** For parallel main circuit breaker applications.
- **UQFP-M:** For series main circuit breaker applications. Split load tab features allow for feed-through capability.
- **UQFB:** (2) 1/0-300 lugs provided on load and line side (cable-in, cable-out).
- **UQFB3:** Three-pole available. Consult factory.
- **UQFB-X:** (2) 1/0-300 lugs provided on load side and (2) line bar bus connections on line side.
- **UQFB-M:** For series main circuit breaker applications. Split load tab features allow for feed-through capability.



Please consult serving utility for their requirements prior to ordering or installing, as specifications and approvals vary by utility, and may require local electrical inspector approval. All installations must be installed by a licensed electrician and must comply with all national and local codes, laws and regulations. Milbank reserves the right to make changes in specifications and features shown without notice or obligation.

# Circuit Breakers

QP (small frame) and QN (large frame) | 120/240 VAC

## 15–125 Amps Breaker Plug-In Type | One-inch Per Pole

Amps	Poles	10K AIC Plug-In	22K AIC Plug-In
15	Single	Q115	Q115H
15	Double	Q215	Q215H
20	Single	Q120	Q120H
20	Double	Q220	Q220H
25	Single	Q125	Q125H
25	Double	Q225	Q225H
30	Single	Q130	Q130H
30	Double	Q230	Q230H
35	Single	Q135	Q135H
35	Double	Q235	Q235H
40	Single	Q140	Q140H
40	Double	Q240	Q240H
50	Single	Q150	Q150H
50	Double	Q250	Q250H
60	Single	Q160	Q160H
60	Double	Q260	Q260H
70	Single	Q170	Q170H
70	Double	Q270	Q270H
80	Double	Q280	Q280H
90	Double	Q290	Q290H
100	Double	Q2100	Q2100H
125	Double	Q2125	Q2125H



QN2200H



QN2200RH



WBJ2200



Q250

## 200 Amps Frame | Plug-In | 10,000 AIC & 22,000 AIC | Two-Pole, Common Trip

Amps	10K AIC Plug-In	22K AIC Plug-In	Handle Location	Wire Range	
				CU	AL
150	QN2150	QN2150H	Left facing	#4-300	#4-300
200	QN2200	QN2200H	Left facing	#4-300	#4-300
150	QN2150R	QN2150RH	Right facing	#4-300	#4-300
200	QN2200R	QN2200RH	Right facing	#4-300	#4-300
150	WBJ2150	—	Centered	#2-300	#2-300
200	WBJ2200	—	Centered	#2-300	#2-300

### Notes

- Load connectors supplied with breakers.
- UL Listed for use with 60°C or 75°C wire.
- Wire sizes shown are lug capacity. Consult NEC Article #310 for specific wire sizes.

Please consult serving utility for their requirements prior to ordering or installing, as specifications and approvals vary by utility, and may require local electrical inspector approval. All installations must be installed by a licensed electrician and must comply with all national and local codes, laws and regulations. Milbank reserves the right to make changes in specifications and features shown without notice or obligation.



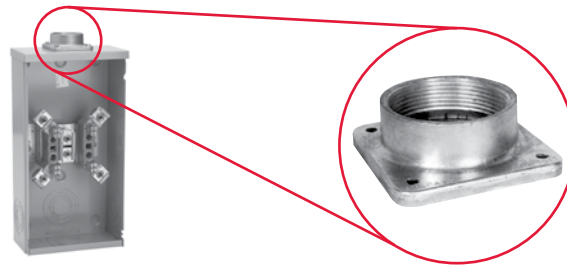
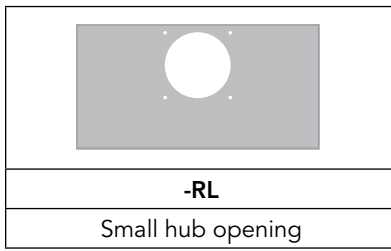

<b>-WL</b>   <b>A7514</b>	<b>-YL</b>   <b>A7515</b>	<b>-ZL</b>   <b>A7516</b>	<b>-DL</b>   <b>A7517</b>	<b>-EL</b>   <b>A7518</b>	<b>-XL</b>   <b>A7551</b>
1" hub	1¼" hub	1½" hub	2" hub	2½" hub	Small closing plate

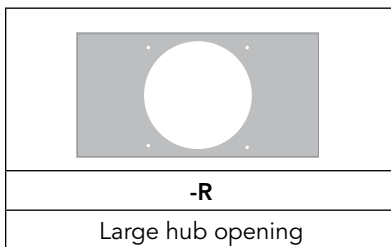

<b>-F</b>   <b>A8110</b>	<b>-G</b>   <b>A8111</b>	<b>-H</b>   <b>A8112</b>	<b>-X</b>   <b>A9064</b>	<b>-RRL</b>   <b>S8324</b>	<b>-RXL</b>   <b>S8324</b>   <b>A7551</b>
3" hub	3½" hub	4" hub	Large closing plate	Large hub opening adapted to small hub opening	Large hub opening adapted to small closing plate

### Notes

- **Suffix:** Add to catalog number for factory installation of hub.
- **Packaging:** Individually packed units for field installation.
- **Abbreviations:** H.O. (hub opening), C.P. (closing plate).
- Hub Mast rated





Please consult serving utility for their requirements prior to ordering or installing, as specifications and approvals vary by utility, and may require local electrical inspector approval. All installations must be installed by a licensed electrician and must comply with all national and local codes, laws and regulations. Milbank reserves the right to make changes in specifications and features shown without notice or obligation.

# Accessories

## Connector Kits, Closing Kits & Generator Interlock

### Connector Kits — For Use with 3/8"-16 Stud Type Units Only

					
Single			Twin		
Suffix	Part #	(3 per set) - 1Ø	Suffix	Part #	(3 per set) - 1Ø
K1	K1539	6-350	K2	K1350	6-350
K3	K1540	4-600 or (2) 1/0-250*	K2L	K1350L	6-350 (non rotating)
K3L	K1540L	4-600 or (2) 1/0-250* (non rotating)	K4	K1541	4-600
Suffix	Part #	(4 per set) - 3Ø	Suffix	Part #	(4 per set) - 3Ø
K5	K3082	6-350	K6	K3442	6-350
K7	K3441	4-600 or (2) 1/0-250*	K8	K3083	4-600

\*For (2) 1/0-250, conductors must be of same size.



### Bypass Link



### Note

Consult factory for proper connector kits for studded meter sockets.

### Closing Covers

	
Meter Closing Plate (Ring Type / Ringless)	Metal Closing Plate (For Ringless Sockets)
6003 - Grey Plastic	CP-21
6116 - Clear Plastic	
6002 - Clear Plastic	

### Disconnect Sleeve



### Isolated Neutral Kit



### ANSI-61-Grey

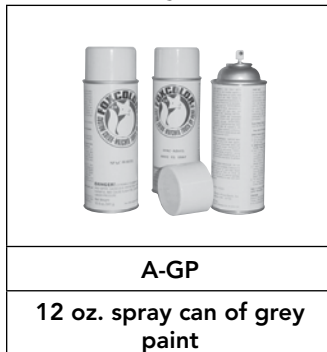

### Pole Hanger Kit

850 comes with 4 pole hangers

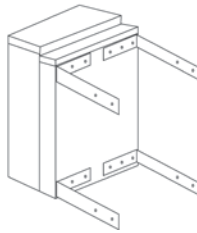



	
Catalog Number	Description of pole hanger brackets
850	Two pair (4 pieces) with mounting hardware

Please consult serving utility for their requirements prior to ordering or installing, as specifications and approvals vary by utility, and may require local electrical inspector approval. All installations must be installed by a licensed electrician and must comply with all national and local codes, laws and regulations. Milbank reserves the right to make changes in specifications and features shown without notice or obligation.

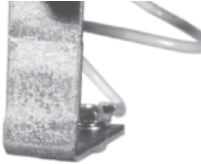

## Fifth Terminals, Tap Connectors & Block Assemblies

### Fifth Terminals

			
<b>5T8K2</b> - 100-200 Amps "Plug-In"	<b>K5T</b> - 200 Amps (Block with Square Hole)	<b>K3865</b> - Heavy Duty Jaw Clamping ( <b>K3866</b> without Neutral Wire)	<b>K3356</b>

### Tap Connectors (3 per set)

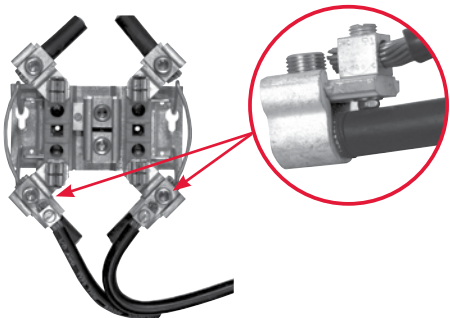
	Replaces the load or line side slide-in nut assembly on Milbank 200 Amps sockets. Allows for a 100 Amps tap location in addition to the #6-350 kcmil load-side connector. <b>K5022</b> includes safety barrier extensions for applications over 300 VAC. Three lugs per kit.
<b>K4977-INT</b> - Internal Hex Wire Range #12 - 1/0	
<b>K4977-EXT</b> - External Hex Wire Range #12 - 1/0	
<b>K5022-INT</b> - Internal Hex (set of 4 w/ barrier) Wire Range #12 - 1/0	

### Triplex Ground

<b>K1190</b> (For factory installed triplex ground, add suffix -TG to catalog number)

### 100 Amps Blocks *(single sockets only)*

<b>BL7474</b> - Block Assembly
<b>BL7499</b> - KK Block Assembly
<b>Z904486-AO</b> - Slotted Nut Assembly
<b>Z802965-AC</b> - Neutral without Nut
<b>Z901925-AC</b> - Hex Nut Set Screw

### 200 Amps Blocks *(single sockets only)*

<b>K4527</b> - Internal Hex Block Assembly (w/ meter support)
<b>K4528</b> - External Hex Block Assembly (w/ meter support)
<b>Z916265-AO</b> - Internal Hex Slide Nut Assembly
<b>Z916264-AO</b> - External Hex Slide Nut Assembly
<b>Z814898-AC</b> - Neutral without Nut



Please consult serving utility for their requirements prior to ordering or installing, as specifications and approvals vary by utility, and may require local electrical inspector approval. All installations must be installed by a licensed electrician and must comply with all national and local codes, laws and regulations. Milbank reserves the right to make changes in specifications and features shown without notice or obligation.



# Enclosed Controls

Attractive | Easy to Install | Secure | Cost-Effective

**57**  
ENCLOSED  
CONTROLS

**Milbank Enclosed Controls** are pad-mounted, weather resistant electrical enclosures consisting of a utility pull section with optional meter socket, and a customer section containing distribution and control equipment. Commercial pedestals are an attractive, secure, easy to install and cost-effective solution when underground remote site power distribution and control equipment is required, replacing unsightly and inefficient strut and backboard structures.



Strut and backboard



Commercial pedestal

## UL Listed as Industrial Control Equipment (File E113855)

### Standard Features

- Type 3R rain-resistant, vandal-resistant cabinet of polyurethane powder coated steel (aluminum or stainless steel also available)
- UL listed as enclosed industrial control equipment (UL508A)
- Isolated lockable and sealable utility metering and lug landing sections
- Lockable customer section for distribution and control equipment with internal deadfront
- Print pocket inside customer section door contains wiring schematics and installation instructions
- Load centers are UL listed for use with various manufacturers' circuit breakers
- All stainless steel external hardware (screws, bolts, hinges, handles, hasps and sealing screws)

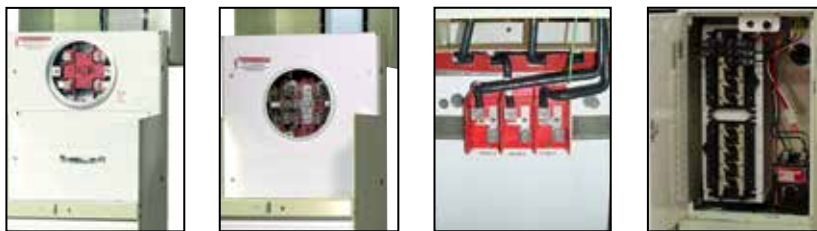

Please consult serving utility for their requirements prior to ordering or installing, as specifications and approvals vary by utility, and may require local electrical inspector approval. All installations must be installed by a licensed electrician and must comply with all national and local codes, laws and regulations. Milbank reserves the right to make changes in specifications and features shown without notice or obligation.







## Applications

These units are ideal for controlling and metering:

- Traffic signals
- Street lighting
- Power distribution for electronic vehicle charging stations
- Communication equipment such as cell towers and telephone vaults
- Event power for fairgrounds, swap meets, outdoor markets, portable offices, holiday lights, etc.
- Outdoor lighting for athletic fields, tennis and basketball courts, parking lots, landscaping and subdivision entrances, etc.

## Available Factory-Installed Options

- Meter sockets: ring type or ringless, up to 400 Amps
- Main and branch breakers or T fuses
- Distribution: copper load centers and panel boards
- Clocks, timers and relays
- Photoelectric cells and controls
- Various power receptacles: pin and sleeve, twist lock or straight blade
- Contactors: lighting, definite purpose, motor starters
- Surge protection and lightning arrestors
- Generator inlets with interlocked breakers
- Push button controls
- Thermostat controls, fans and heating strips
- Power blocks and terminal blocks
- Steel, aluminum and plywood backboards
- Transformers
- Interlock devices for circuit breakers

## Options

- Available in steel, aluminum (raw painted or anodized) or stainless steel construction with powder coated finish available in eight standard colors or special-ordered RAL colors
- Available for applications up to 400 Amps, 120V, 208V, 240V, 277V, 480V - 1Ø or 3Ø

## Accessories

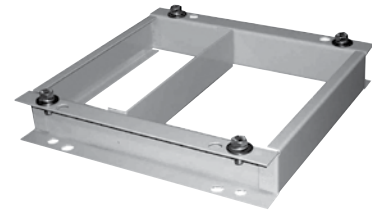

Padmount bases available for all pedestal sizes, inquire with your representative for details

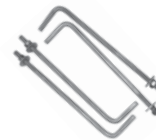

### CP-ABK5/8

Anchor bolt kit (includes four 5/8 - 13 x 18" anchor bolts)



### 105J

Fifth terminal kit for use with ring type meter sockets



### K3865

Fifth terminal kit for use with ringless meter sockets



### CP-TC7D

7-day time clock kit

### CP-TC24H

24-hour time clock kit

### CP-TCWIRE

Male 4-pin connector and wiring harness for use with time clocks other than above



### CP-PE-HOA-3POS

HOA switch for field installation



Please consult serving utility for their requirements prior to ordering or installing, as specifications and approvals vary by utility, and may require local electrical inspector approval. All installations must be installed by a licensed electrician and must comply with all national and local codes, laws and regulations. Milbank reserves the right to make changes in specifications and features shown without notice or obligation.

# Enclosed Controls

## Surface-Mount Compact Design

**59**  
SURFACE  
MOUNT  
ENCLOSED  
CONTROLS

### Surface-Mount Commercial Pedestal

Originally developed for small cellular communications, the surface-mount enclosed control offers the flexibility of larger enclosed controls products with a smaller footprint and several mounting options.



#### Features

- Easy installation
- Overhead and underground entry and exit, all in one unit
- Meter and components in one enclosure
- UL508A & UL891
  - Custom component configurations
  - UL listing covers all internal components
- Can be mounted on multiple surfaces
  - Walls
  - Poles – narrow profile will have minimal extension past sides
  - H Frames (Strut)
- Multiple bypass options available
- Monitoring options available
- Can be powder coated in any Milbank standard EC colors or custom colors.



#### Benefits

- Does not take up sidewalk space
- Flood resistant
- Eliminates need for connecting components - Wire in - Wire Out

#### Applications



Communications  
Power  
Distribution



Lighting  
Control

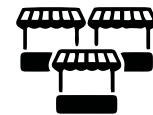

Streetscape  
Power  
Distribution

Please consult serving utility for their requirements prior to ordering or installing, as specifications and approvals vary by utility, and may require local electrical inspector approval. All installations must be installed by a licensed electrician and must comply with all national and local codes, laws and regulations. Milbank reserves the right to make changes in specifications and features shown without notice or obligation.



### Main Load Center Commercial Pedestal

1Ø3 wire 120/240V or 208Y/120V

*Application: remote site service for multiple loads*

**Milbank Main Load Center Commercial Pedestals** are designed to handle the vast majority of all requirements in a standard, stocked configuration.

- All units feature a load center with a plug-on, back-fed main breaker.
- Standard units are equipped with with a 16 circuit load center in the 100 Amps or 24 circuit load center in 200 Amps models
- Sub-feed lugs to allow feeding an external panel.

If your application requires turning loads on based on "dusk-to-dawn" requirements, be sure to see the Milbank Switched Load Center Commercial Pedestal products on the following page.

#### Features

These units include everything required for remote site service:

- Expandable: load centers allow for future expansion without costly modifications.
- All units feature a 200 Amps meter socket with optional field-installable fifth terminal kit available.
- 22K Amps interrupting capacity (AIC) standard.
- Optional mounting base can be embedded in concrete for fast, easy installation.
- Separate sealable and lockable utility termination section.
- Separate sealable and lockable metering section.
- Separate sealable and lockable customer section with a load center for "always on" loads that include a main circuit breaker, 20 (125 or 200 Amps model) or 14 (100 Amps model) blank breaker spaces and a circuit directory to document configuration.



# Enclosed Controls

## Switched Load Center Commercial Pedestals

61

SWITCH-LOAD  
COMMERCIAL  
PEDESTALS

### Switched Load Center Commercial Pedestals

1Ø3 wire 120/240V or 208Y/120V

Designed not only to provide power for various loads, but also to switch specific loads on and off under certain conditions. A photoelectric cell is used for these controlled loads, and an optional time clock is also available.

#### Features

These units include everything required for remote site service:

- Expandable: load centers allow for future expansion without costly modifications.
- All units feature a 200 Amps meter socket with optional field-installable fifth terminal kit available.
- 22K Amps interrupting capacity (AIC) standard.
- Optional mounting base can be embedded in concrete for fast, easy installation.
- Separate sealable and lockable utility termination section.
- Separate sealable and lockable metering section.
- Separate sealable and lockable customer section with a control circuit including PE receptacle, Lexan® window, glare shield, Hand-Off-Auto (HOA) switch, contractor controlling a 16-circuit load center for controlled loads, a pre-mounted DIN rail and pre-wired connector to add an optional "plug-and-play" time clock kit for PE on and TC off operation and a circuit directory to document configuration.
- A load center for "always on" loads that includes a main circuit breaker, a control power circuit breaker, a switched load center main breaker, nine (125 or 200 Amps model) or 11 (100 Amps model) blank breaker spaces and a circuit directory to document configuration.



Ringless Lever Bypass shown



Traffic Signals

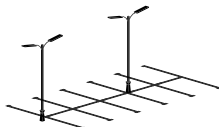

Parking Lots



Highways

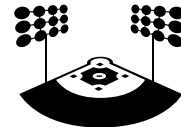

Athletic Field Lighting

Please consult serving utility for their requirements prior to ordering or installing, as specifications and approvals vary by utility, and may require local electrical inspector approval. All installations must be installed by a licensed electrician and must comply with all national and local codes, laws and regulations. Milbank reserves the right to make changes in specifications and features shown without notice or obligation.



# Enclosed Controls

## 400 Amps Commercial Pedestals



Designed to provide a weather and vandal resistant metered enclosure for various loads and distribution. Each pedestal has been designed to handle a wide range of applications using standard, stocked configurations.

- Choice of a single main breaker or twin service disconnect breakers gives flexibility to the pedestal design.
- Optional distribution with feed-through lugs below the service disconnect breakers allows the pedestal to handle numerous applications.
- Typical applications include remote homes where the metering is best located at the curb side or other remote area. The pedestal can also provide power to secondary residence, on-site business, workshop, irrigation, lighting, security or other secondary load.
- Refer to page 18 for color options

### Features

---

These units include everything required for remote service:

- Main circuit breaker or dual service disconnects
- Expandable: load center units allow for future expansion without costly modifications
- Optional mounting base can be embedded in concrete for fast, easy installation
- Separate sealable and lockable utility termination section with lug termination
- Separate sealable and lockable metering section
- A separate sealable and lockable customer section with a circuit directory and a print pocket to hold all documentation
- Meter socket options include ring type with bypass studs, ringless with heavy duty lever bypass, or K-Type bolt-on

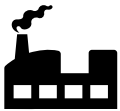

Commercial Job Sites



Remote Site for  
Residential &  
Commercial Job Sites

# Enclosed Controls

## Battery Backup Commercial Pedestals

63

BATTERY BACKUP  
COMMERCIAL  
PEDESTALS



Designed to provide battery backup power for various loads, and to switch specific loads on and off under certain conditions; a photoelectric cell or time clock to control lighting circuits, as an example. Metered and unmetered power distribution options are available. The back-up power pedestal is designed to handle the vast majority of today's back-up power requirements. By using a 19" rack design, shelves can be adjusted to accommodate the required batteries and manufactures DC to AC inverters, transfer switches and other related equipment. This design gives the user a wide range of design and configuration options. Complete turnkey, ready to power-up pedestals are offered along with basic units ready to accept batteries and inverters supplied by others.

### Features

- 100 through 320 Amps meter socket with the option of either a ring type socket (conforms to EUSERC 308) with or without test/bypass blocks or a heavy duty ringless socket with lever bypass
- Separate sealable utility termination compartment
- An isolated separate customer section with service disconnects, power distribution options and power control
- 19" wide rack in customer compartment for easy layout of equipment
- Battery trays
- Thermostat with cooling fan
- Filtered louvers for heat rise flow through ventilation
- Three point door latch (key or pad lockable)

### Note

- May require customization based on regional requirements



Traffic Signals



Communications  
Power Distribution



Parking Lots



Camera & Security  
Locations

### Options

- Manual bypass switch
- Transfer switch for generator power back-up
- Generator inlet receptacles 30 Amps through 200 Amps
- Pad lockable provision for receptacles
- Police access door
- Metered load center distribution
- Unmetered load center distribution
- Photo electric controls (for street lighting)
- Time clocks
- HOA switches
- Contactors
- GFI duplex receptacles
- Thermostat for heating control
- Heating pads or elements
- Roll out shelves for batteries
- Surge arrestors and lighting arrestors

Please consult serving utility for their requirements prior to ordering or installing, as specifications and approvals vary by utility, and may require local electrical inspector approval. All installations must be installed by a licensed electrician and must comply with all national and local codes, laws and regulations. Milbank reserves the right to make changes in specifications and features shown without notice or obligation.





# Enclosed Controls

## Power Transfer Commercial Pedestals



Providing metered or unmetered AC power, distribution, surge suppression, mechanical interlock and stand-by generator receptacle — all in a neat, compact pedestal.

### Features

- 120/240V 1Ø3W through 277/480V 3Ø4W ratings
- Metered or unmetered units
- Choice of EUSERC ring type or ringless meter sockets
- 60 Amps through 400 Amps ratings
- Pad lockable, isolated utility compartments
- 20 Amps GFCI convenience receptacle
- Lockable recessed generator receptacle door
- Utility and generator indicator light options
- All stainless steel hardware
- Galvanized steel, aluminum or stainless steel cabinet options
- Custom designs available

### Note

- May require customization based on regional requirements



Traffic Signals



Pump & Lift  
Stations



Communications  
Power Distribution



Please consult serving utility for their requirements prior to ordering or installing, as specifications and approvals vary by utility, and may require local electrical inspector approval. All installations must be installed by a licensed electrician and must comply with all national and local codes, laws and regulations. Milbank reserves the right to make changes in specifications and features shown without notice or obligation.



# Enclosed Controls

## CT Metered Commercial Pedestals

**65**  
CT METERED  
COMMERCIAL  
PEDESTALS



Designed to be used where a smaller service package would be a better choice over larger switchgear equipment, these pedestals have amperage ratings of 400 to 800 Amps at voltages up through 480 volt three phase.

### Features

- Up to 800 Amps
- A low profile CT pedestal
- All utility equipment is isolated in separated pad lockable and sealable compartments
- Separate customer compartment designed to hold distribution and control equipment
- Dead front customer construction
- Optional mounting base
- Optional construction in steel, aluminum and stainless steel
- Wide choice of powder paint colors

### Note

- May require customization based on regional requirements

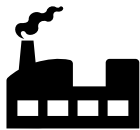

Commercial &  
Industrial Control  
Systems



Pump & Lift  
Stations



Water Treatment  
Plants



Electric Vehicle  
Charging Stations

Please consult serving utility for their requirements prior to ordering or installing, as specifications and approvals vary by utility, and may require local electrical inspector approval. All installations must be installed by a licensed electrician and must comply with all national and local codes, laws and regulations. Milbank reserves the right to make changes in specifications and features shown without notice or obligation.





Provides a sleeker, smaller footprint, with wireway access on the side of the unit rather than the back, allowing maximum flexibility to place the pedestal anywhere physical space is at premium.

Providing unmetered AC power, distribution, surge suppression, mechanical interlock and stand-by generator receptacle — all in a neat, compact pedestal.

### Features

- 100 or 200 Amps
- Vandal-resistant, secure and attractive design
- Customer compartment with distribution and control equipment with swing dead front door, secured with both a hasp/latch and draw latch outer door
- Utility metering compartment protected with a hinged hood, increasing resistance to meter vandalism
- Small footprint
- Wireway located on left side of pedestal for utility incoming wire, allowing pedestal to be mounted with back as close as 14" to walls or structures
- Available in 12" and 20" widths and 50" and 63" (metered) and 43" (unmetered) heights
- Includes a print pocket for plans and drawings
- Voltage range: 120V–480V
- Compatible with both ringless and ring type meter sockets, 4–7 terminals
- Available in a wide array of colors, including but not limited too all ANSI powder coated paint colors upon request
- Pedestal mounting base option saves time and labor to install on a cement pad—no anchor bolts required
- Powder coated G90 galvanized steel or Aluminum; raw, annodized or powder coated, as well as stainless steel exterior options

### Note

- May require customization based on regional requirements



Water Treatment  
Plants



Highways



Parks &  
Landscaping



**Direct bury pedestals** offer many advantages. With no need to coordinate, buy or wait for concrete, installation time can be cut down to less than an hour. Traditional direct bury pedestals are awkward to transport and handle and can only be used in a direct bury application. Milbank's modular design offers flexibility and convenience for distributors



and contractors alike. **It's constructed with 14 gauge steel and only available for 12" pedestals.**



Please consult serving utility for their requirements prior to ordering or installing, as specifications and approvals vary by utility, and may require local electrical inspector approval. All installations must be installed by a licensed electrician and must comply with all national and local codes, laws and regulations. Milbank reserves the right to make changes in specifications and features shown without notice or obligation.

# Watt-hour Meter Forms

Standard Forms | Transformer Rated or Self-Contained

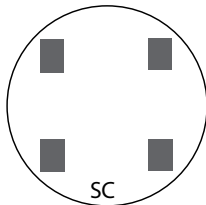

2 and 3-WIRE FORMS  
1S & 2S

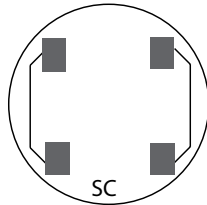

2 and 3-WIRE FORMS  
1S & 2S with BYP ASS

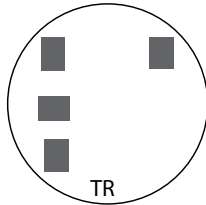

2-WIRE FORM 3S  
5th Term. 9 o'clock

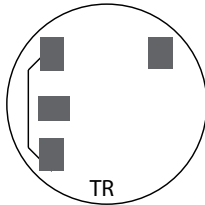

2-WIRE FORM 3S  
with BYP ASS

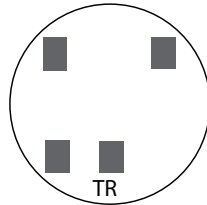

2-WIRE FORM 3S  
5th Term. 6 o'clock

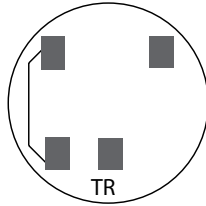

2-WIRE FORM 3S  
with BYP ASS

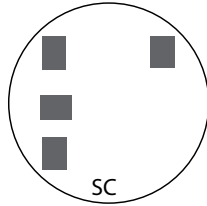

2 ELEMENT  
3-WIRE NETWORK  
FORM 12S 5th  
TERM. 9 o'clock

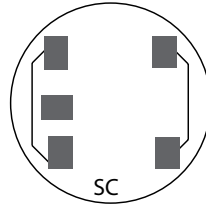

2 ELEMENT 3-WIRE  
NETWORK FORM 12S  
with BYP ASS  
5th Term. 9 o'clock

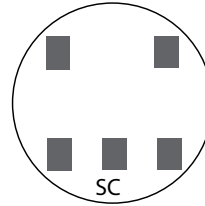

2 ELEMENT  
3-WIRE NETWORK  
FORM 12S 5th  
TERM. 6 o'clock

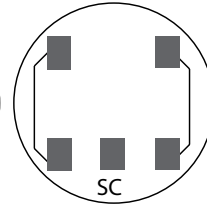

2 ELEMENT 3-WIRE  
NETWORK FORM 12S  
with BYP ASS  
5th Term. 6 o'clock

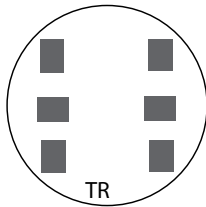

3-WIRE FORM 4S

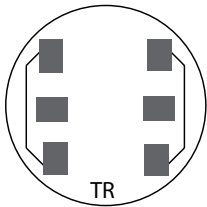

3-WIRE FORM 4S  
WITH BYP ASS

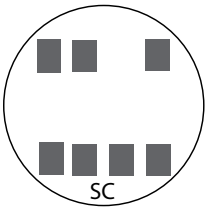

2 or 3 ELEMENT  
3 4W Y or Δ  
Y FORM 14S  
Δ FORM 15S

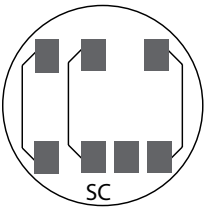

2 or 3 ELEMENT  
3 4W Y or Δ  
FORMS 14S & 15S  
with BYP ASS

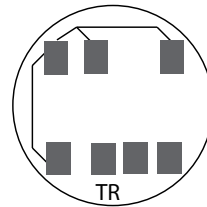

2 ELEMENT  
3 4W Y or Δ  
Y FORM 7 S  
Δ FORM 24S  
with BYP ASS

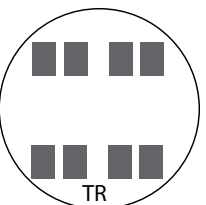

2 ELEMENT  
2 3W, 2 4W, 3 3W  
FORM 5 S

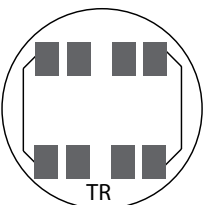

2 ELEMENT 2 3W,  
2 4W, 3 3W  
FORM 5S with  
BYP ASS

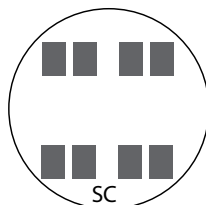

2 ELEMENT  
2 3W, 2 4W, 3 3W  
FORM 13S

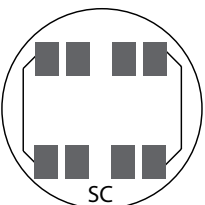

2 or 3 ELEMENT  
2 3W, 2 4W, 3 3W  
FORM 13S with  
BYP ASS

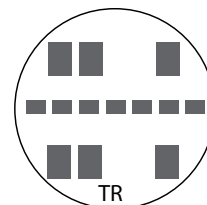

2 or 3 ELEMENT  
2 3W, 2 4W, 3 3W  
Y FORM 9 S  
Δ FORM 8S

TR = TRANSFORMER RATED  
SC = SELF CONTAINED

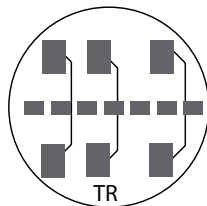

2 or 3 ELEMENT  
3 4W Y or Δ  
FORMS 8S & 9 S  
with BYP ASS

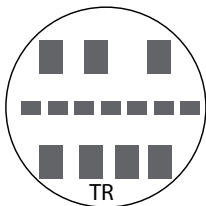

2 ELEMENT  
3 4W Y  
FORM 6 S

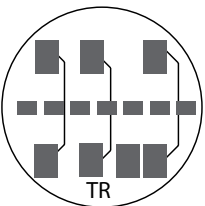

2 ELEMENT  
3 4W Y  
FORM 6S  
with BYP ASS

Please consult serving utility for their requirements prior to ordering or installing, as specifications and approvals vary by utility, and may require local electrical inspector approval. All installations must be installed by a licensed electrician and must comply with all national and local codes, laws and regulations. Milbank reserves the right to make changes in specifications and features shown without notice or obligation.



**DIAGRAM A**  
1 $\emptyset$ 2W with 1 P.T. & 1 C.T.  
Single Stator Meter(2W1 $\emptyset$ ) - Form 3S  
5T Socket, Test Switch #TS04-0101

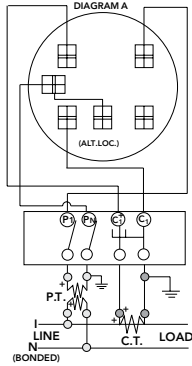

**DIAGRAM B**  
1 $\emptyset$ 3W with 1 C.T.  
Single Stator Meter (2W1 $\emptyset$ ) - Form 3S  
5T Socket, Test Switch #TS04-0101

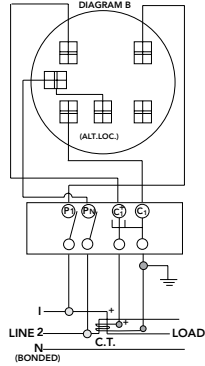

**DIAGRAM C**  
1 $\emptyset$ 3W with 2 C.T.'s  
Single Stator Meter (3W1 $\emptyset$ ) - Form 4S  
6T Socket, Test Switch #TS07-0105

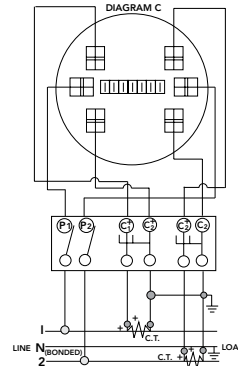

**DIAGRAM D**  
1 $\emptyset$ 3W or 3W Network with 2 C.T.'s  
2 Stator Meter - Form 5S  
8T Socket, Test Switch #TS07-0105

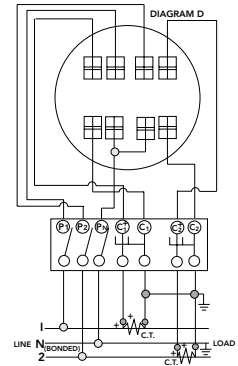

**DIAGRAM E**  
3 $\emptyset$ 3W "A" with 2 P.T.'s & 2 C.T.'s  
2 Stator Meter - Form 5S  
8T Socket, Test Switch #TS07-0105

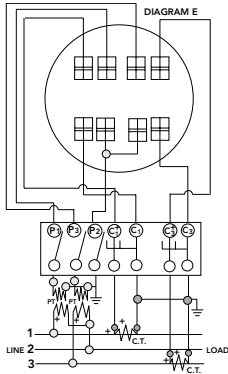

**DIAGRAM F**  
3 $\emptyset$ 3W "A" with 2 C.T.'s  
2 Stator Meter - Form 5S  
8T Socket, Test Switch #TS07-0105

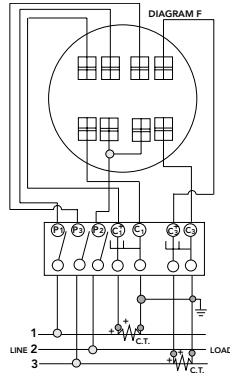

**DIAGRAM G**  
3 $\emptyset$ 4W "Y" with 3 C.T.'s  
2 1/2 Stator Meter - Form 6S  
13T Socket, Test Switch #TS10-0109

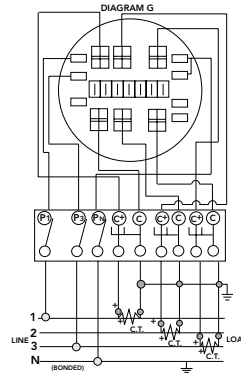

**DIAGRAM H**  
3 $\emptyset$ 4W "Y" with 2 P.T.'s & 3 C.T.'s  
2 1/2 Stator Meter - Form 6S  
13T Socket, Test Switch #TS10-0109

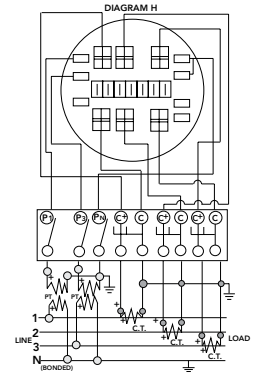

**DIAGRAM I**  
3 $\emptyset$ 4W "Y" or "A" with 3 C.T.'s  
"Y" 3 Stator Meter - Form 9S  
"A" 2 Stator Meter - Form 8S  
13T Socket, Test Switch #TS10-0109

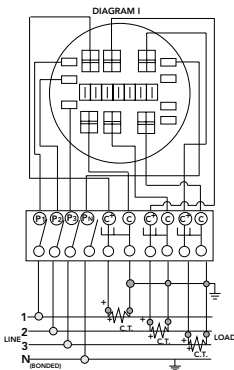

**DIAGRAM J**  
3 $\emptyset$ 4W "Y" with 3 P.T.'s & 3 C.T.'s  
3 Stator Meter - Form 9S  
13T Socket, Test Switch #TS10-0109

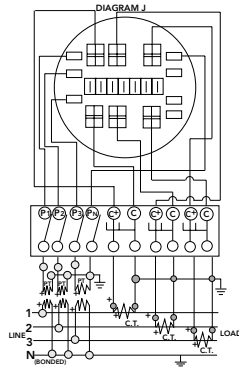

**Pre-wiring:** If standard factory pre-wiring is required, refer to wiring diagrams on this page. Determine appropriate diagram and send a copy with order. If custom factory pre-wiring is required, specify on order. Be sure to include meter socket catalog number, test switch make and catalog number, meter form number and provide a copy of your wiring diagram.



Please consult serving utility for their requirements prior to ordering or installing, as specifications and approvals vary by utility, and may require local electrical inspector approval. All installations must be installed by a licensed electrician and must comply with all national and local codes, laws and regulations. Milbank reserves the right to make changes in specifications and features shown without notice or obligation.

# Conduit, Ampacity & SCCR

## Reference Information

### MAXIMUM NUMBER OF CONDUCTORS IN CONDUIT

Table from 2008 NEC Code Reference: Rigid Metal Conduit

Type	Conductor Size (AWG/kcmil)	Conduit Trade Sizes (Inches)									
		½	¾	1	1¼	1½	2	2½	3	3½	4
THHN, THWN, THWN-2	12	9	16	26	46	62	102	146	225	301	387
	10	6	10	17	29	39	64	92	142	189	244
	8	3	6	9	16	22	37	53	82	109	140
	6	2	4	4	12	16	27	38	59	79	101
	4	1	2	4	7	10	16	23	36	48	62
	3	1	1	3	6	8	14	20	31	41	53
	2	1	1	3	5	7	11	19	26	34	44
	1	1	1	1	4	5	8	12	19	25	35
	1/0	1	1	1	3	4	7	10	16	21	27
	2/0	0	1	1	2	3	6	8	13	18	23
XHH, XHHW, XHHW-2	3/0	0	1	1	1	3	5	7	11	15	19
	4/0	0	1	1	1	2	4	6	9	12	16
	4	1	2	4	7	10	16	24	37	49	63
	2	1	1	3	5	7	12	17	26	35	45
	1/0	1	1	1	3	4	7	10	16	22	28
	2/0	0	1	1	2	3	6	9	13	18	23
	4/0	0	1	1	1	2	4	6	9	12	16
	250	0	0	1	1	1	3	5	7	10	13
	350	0	0	1	1	1	2	3	6	7	10
	500	0	0	0	1	1	1	2	4	5	7
750	0	0	0	0	1	1	1	3	4	5	

This table is for concentric stranded conductors only. For cables with compact conductors refer to NEC. Refer to latest NEC Code or Local Codes for updated requirements.

#### \* ALLOWABLE AMPACITIES OF INSULATED COPPER & \*\* ALUMINUM CONDUCTORS (3W IN CONDUIT) 75° C (167° F)

A		AL or **CU-Clad AL	
A	B	A	B
18	—	—	—
16	—	—	—
14	20†	—	—
12	25†	12	20†
10	35†	10	30†
8	50	8	40
6	65	6	50
4	85	4	65
3	100	3	75
2	115	2	90
1	130	1	100
1/0	150	1/0	120
2/0	175	2/0	135
3/0	200	3/0	155
4/0	230	4/0	180
250	255	250	205
300	285	300	230
350	310	350	250
400	335	400	270
500	380	500	310
600	420	600	340
700	460	700	375
750	475	750	385

A = Size: AWG/MCM  
 \*B = Ampere Rating for Insulation Types:  
**FEPW, RH, RHW, THW, THWN, XHHW, USE, 2W.**  
 \*\*C = Ampere Rating for Insulation Types:  
**RH, RHW, THW, THWN, XHHW, USE**  
 (Per NEC table 310-16)

#### AMPACITY CORRECTION FACTORS

Ambient Temp. C°	Correction Factor	Ambient Temp. F°
21 - 25	1.05	70 - 77
25 - 30	1.00	78 - 86
31 - 35	.94	87 - 95
36 - 40	.88	96 - 104
41 - 45	.82	105 - 113
46 - 50	.75	114 - 122
51 - 55	.67	123 - 131
56 - 60	.58	132 - 140
61 - 65	.33	141 - 158

Overall ampere ratings of U/L listed Milbank multiple position meter sockets are based on 2008 N.E.C. Handbook Article 220-84 and ANSI / UL-414 (except where restricted by line connector size.) These requirements provide for a diversity factor / demand factor being utilized in determining the overall (main bus / lug) rating of a gang socket. All Milbank U/L listed gang sockets meet or exceed these diversity factor/demand and factor requirements. Standard overall ampacity ratings for U/L listed and non U/L listed gang sockets are as shown in the chart below. Ampere ratings of meter sockets are based on the meter socket being wired with 75° C insulated wire conductor, sized in accordance with Table 310-16 of the National Electric Code.

#### GANG SOCKET OVERALL AMPACITIES

# of Meter Pos.	100A/Pos. Ampacity	125A/Pos. Ampacity	150A/Pos. Ampacity	200A/Pos. Ampacity
2	200A	200A	200A	200A #
3	200A	225A	225A	270A
4	200A	250A	270A	360A
5	225A	285A	338A	450A
6	270A	330A	396A	528A

† Unless otherwise permitted elsewhere in the Code, the overcurrent protection for conductor types marked with an obelisk (†) shall not exceed 15 amps for 14 AWG, 20 amps for 12 AWG, and 30 amps for 10 AWG copper; or 15 amps for 12 AWG and 25 amps for 10 AWG aluminum and copper-clad aluminum after any correction factors for ambient temperature and number of conductors have been applied.  
 # Some constructions are rated at 400 amps overall (1252). Contact your sales representative for more information. Refer to latest NEC Code or Local Codes for updated requirements.

Please consult serving utility for their requirements prior to ordering or installing, as specifications and approvals vary by utility, and may require local electrical inspector approval. All installations must be installed by a licensed electrician and must comply with all national and local codes, laws and regulations. Milbank reserves the right to make changes in specifications and features shown without notice or obligation.



### Important Note

In addition to national and local electrical codes, many utilities have specific requirements for metering equipment. Always consult the serving utility for their specifications and requirements prior to ordering or installing Milbank meter mounting equipment.

### Before Energizing

1. Give equipment a thorough visual examination to determine that:
  - A. No shipping or installation damage exists.
  - B. Proper clearances have been maintained.
  - C. All connections have been made.
  - D. Equipment is clean and dry.
2. Make a thorough examination to:
  - A. Verify tightness of all bolted connections (see table below).
  - B. Manually operate all circuit breakers, switches, relays, etc.
  - C. Check rigidity of all mountings, bus bars and components.
  - D. Use test equipment to check continuity of circuitry and integrity of insulation.
3. All switches and circuit breakers should be in the "off" position.
4. Verify that manual meter bypass (if applicable) is in non-bypass position.
5. Install cover and/or close doors.
6. If installation is not being energized at this time, follow "after-energizing" steps listed below. These steps will secure the installation in case of accidental energization.

### When Energizing

Use caution and follow established safety procedures:

- 1) Wear safety apparel.
- 2) Use safety equipment.
- 3) Take action to prevent injury to yourself and others in the event of failure of the installation.
- 4) Take action to prevent/decrease damage to property in the event of failure of the installation.
- 5) If you are unsure how to safely energize the installation, get someone who is knowledgeable to do it.

### After Energizing

Secure the installation:

- 1) To prevent accidental contact with energized parts, cover all openings with approved filler devices.
- 2) To prevent unauthorized access, secure all covers and/or doors with approved security devices.
- 3) Attach/post information to advise others of potential hazards associated with the installation.

### Recommended Torque for General Applications\*

Nominal Size	Joint Description		Head Type	Torque (Inch Lbs.)
	Screw	Nut		
10	Brass	Brass Nut or Extruded Hole	All	20-25 inch lbs.
10	Steel	Copper or Aluminum Busbar ≤ 1/8"	All	25-30 inch lbs.
10	Steel	Steel Nut or Extruded Hole; CU or AL Busbar > 1/8"	All	30-35 inch lbs.
12	Steel	Aluminum Extruded Hole	All	30-35 inch lbs.
12	Steel	Steel Nut or Extruded Hole	All	40-50 inch lbs.
1/4	Steel	Aluminum Extruded Hole	All	40-50 inch lbs.
1/4	Steel	Steel Nut or Extruded Hole; CU or AL Busbar	All	50-60 inch lbs.
5/16	Steel	Aluminum Extruded Hole	Hex	60-70 inch lbs.
5/16	Steel	Steel Nut or Extruded Hole; CU or AL Busbar	Hex	100-150 inch lbs.
3/8	Steel	Steel Nut	Hex	150-200 inch lbs.
1/2	Steel	Steel Nut	Hex	200-250 inch lbs.

\* Interior labels typically indicate the required torque for wire connectors and studs, and should be referenced first.  
**CU:** Copper  
**AL:** Aluminum



Please consult serving utility for their requirements prior to ordering or installing, as specifications and approvals vary by utility, and may require local electrical inspector approval. All installations must be installed by a licensed electrician and must comply with all national and local codes, laws and regulations. Milbank reserves the right to make changes in specifications and features shown without notice or obligation.

## Materials

### Steel Quality

---

The meter equipment listed in this catalog is made of galvanized steel (AISI\* G90) to afford the best possible weather proofing.  
\*American Iron and Steel Institute.

### Steel Sheet

---

16 gauge, galvanized, sheet: 1 1/4 oz./ sq.ft. class zinc-coated. (AISI G90)  
14 gauge, galvanized, sheet: 1 1/4 oz./ sq.ft. class zinc-coated.

### Aluminum Extrusion

---

Wire-Terminals: Alloy; 6061-T6, Tin-plated for CU/AL wire.  
Bus Bar: Alloy; 6101-O & 6063-O

### Aluminum Sheet

---

3000 series aluminum sheet, H14, or 5052 series aluminum sheet, H32. Where applicable thicknesses range from .064-.125

### Copper Sheet & Bus

---

Electrolytic copper with tin plating in most applications.

### Insulating Materials

---

- In most units, support bases for current-carrying components are molded from fiberglass reinforced high-strength, track resistant, thermoset polyester molding compounds.
- Clear or black safety shields and polarity barriers are molded from high-strength, track resistant, polycarbonate molding compounds.
- Various sheet insulating materials, as appropriate for the application are utilized in the fabrication of flat, formed and punched component parts and barriers.

## Finish

### Process

---

Light gray state-of-the-art electrostatically applied powder paint offers a durable, non-fading finish. For further information concerning the chemical analysis of the weather resistant finish, please contact the factory.

### Metal Fasteners

---

Zinc-coated with a chromate dip.

## Ratings & Compliance

### Ratings & Compliance

---

All Milbank electrical enclosures in this catalog are rated "Type 3R Enclosure" unless specified otherwise on the product's page. All enclosures with a UL designation are constructed per the appropriate UL Standard and may be installed per the National Electric Code. UL procedure files associated with the UL Standards are listed as follows: Meter Sockets (UL 414, File E30202), Test Switches (UL 414, File E62531), Power Outlets (UL 231, File E90945), Panelboards (UL 67, File E32628) and Pullout Switches (UL 1429, File E133062). Additional standards are utilized as applicable: Meter Sockets (ANSI C12.7), Test Switches (ANSI C12.9) and Panelboards (NEMA PB-1).

Please consult serving utility for their requirements prior to ordering or installing, as specifications and approvals vary by utility, and may require local electrical inspector approval. All installations must be installed by a licensed electrician and must comply with all national and local codes, laws and regulations. Milbank reserves the right to make changes in specifications and features shown without notice or obligation.





850.....	46	K5935-10GR .....	39	Q270H.....	44
6002.....	46	K5935-11GR .....	39	Q280.....	44
6003.....	46	K5935-2/1450.....	39	Q280H.....	44
6116.....	46	K5935-36GR .....	39	Q290.....	44
323412-SC3RA-DUKE .....	35	K5935-41 .....	39	Q290H.....	44
323412-SC3R-DUKE .....	35	K5935-54 .....	39	QN2150.....	44
363612-CT3R-SP4 .....	35	K5T .....	47	QN2150H .....	44
404014-CT3RA-DUKE .....	35	K8180 .....	46	QN2150R.....	44
404014-CT3R-DUKE.....	35	M5-144 .....	46	QN2150RH .....	44
484814-CT3R-SP1 .....	35	Q115.....	44	QN2200.....	44
5T8K2 .....	47	Q115H.....	44	QN2200H .....	44
A7514.....	45	Q120.....	44	QN2200R.....	44
A7515.....	45	Q120H.....	44	QN2200RH .....	44
A7516.....	45	Q125.....	44	S8324.....	45
A7517.....	45	Q125H.....	44	S8324.....	45
A7518.....	45	Q130.....	44	TS04-0101 .....	33
A7551.....	45	Q130H.....	44	TS04-0102 .....	33
A7551.....	45	Q135.....	44	TS04-0103 .....	33
A8110.....	45	Q135H.....	44	TS04-0104 .....	33
A8111.....	45	Q140.....	44	TS07-0018 .....	33
A8112.....	45	Q140H.....	44	TS07-0022 .....	33
A9064.....	45	Q150.....	44	TS07-0049 .....	33
A-GP.....	46	Q150H.....	44	TS07-0059 .....	33
BL7474 .....	47	Q160.....	44	TS07-0105 .....	33
CP-21.....	46	Q160H.....	44	TS07-0106 .....	33
K1047 .....	46	Q170.....	44	TS07-0107 .....	33
K1190 .....	47	Q170H.....	44	TS07-0108 .....	33
K1350 .....	26	Q2100.....	44	TS10-0109 .....	33
K1350 .....	46	Q2100H.....	44	TS10-0110 .....	33
K1350L .....	46	Q2125.....	44	TS10-0111 .....	33
K1539 .....	26	Q2125H.....	44	TS10-0112 .....	33
K1539 .....	46	Q215.....	44	U1079-RRL-K3 .....	11
K1540 .....	26	Q215H.....	44	U1129-O-K3L-K2L .....	11
K1540 .....	46	Q220.....	44	U1232-RRL-KK-K1.....	21
K1540L .....	46	Q220H.....	44	U1233-RRL-KK-K1.....	21
K1541 .....	26	Q225.....	44	U1234-RXL-KK-K1 .....	21
K1541 .....	46	Q225H.....	44	U1252-RRL-KK-K1-BLG-SLVG.....	22
K3082 .....	46	Q230.....	44	U1252-RRL-KK-K1-SLVG.....	22
K3083 .....	46	Q230H.....	44	U1253-RRL-KK-K1-BLG-SLVG.....	22
K3356 .....	47	Q235.....	44	U1253-RRL-KK-K1-SLVG.....	22
K3441 .....	46	Q235H.....	44	U1254-RXL-KK-K1-BLG-SLVG.....	22
K3442 .....	46	Q240.....	44	U1254-RXL-KK-K1-SLVG.....	22
K3865 .....	47	Q240H.....	44	U1255-RXL-KK-K1-BLG-SLVG.....	22
K4527 .....	47	Q250.....	44	U1255-RXL-KK-K1-SLVG.....	22
K4528 .....	47	Q250H.....	44	U1256-RXL-KK-K1-BLG-SLVG.....	22
K4977-EXT.....	47	Q260.....	44	U1256-RXL-KK-K1-SLVG.....	22
K4977-INT .....	47	Q260H.....	44	U1797-O-K3L-K2L .....	11
K5400-BRIDGE-2POS.....	39	Q270.....	44	U1797-O-K3L-K2L-BLG .....	11



Please consult serving utility for their requirements prior to ordering or installing, as specifications and approvals vary by utility, and may require local electrical inspector approval. All installations must be installed by a licensed electrician and must comply with all national and local codes, laws and regulations. Milbank reserves the right to make changes in specifications and features shown without notice or obligation.

U1980-O-KK.....9	U4835-X-2/200-BL.....17	U5764-X-200-CB.....20
U1980-O-KK-BLG.....9	U4881-O-50GB.....8	U5765-X-200-CB.....20
U2120-X-K7.....12	U4881-O-60GB.....8	U5767-X-200-CB.....20
U2594-X.....12	U4905-X.....11	U5784-O-200-CB.....20
U2594-X-BLG.....12	U4905-X-BLG.....11	U5787-O-200-CB.....20
U2732-XT.....25	U4908-O-11GR.....40	U5796-X-400-CB.....20
U2733-XT.....25	U5000-XL.....41	U5797-O-400-CB.....20
U2734-XT.....25	U5000-XL-41.....41	U5799-O-400-CB.....20
U2735-XT.....25	U5000-XL-55.....41	U5844-PXL-200-KK.....14
U2736-XT.....25	U5000-XL-75.....41	U5844-PXL-200-KK-BLG.....14
U2852-X.....26	U5059-X-2/200-K3L.....17	U5871-XL-200.....16
U2852-X.....27	U5059-X-K3L.....17	U5882-X-KK-BLG.....28
U2853-X.....26	U5100-XL.....41	U5883-X-KK-BLG.....28
U2853-X.....27	U5100-XL-41.....41	U5884-X-KK-BLG.....28
U2854-X.....26	U5100-XL-55.....41	U5885-X-KK-BLG.....28
U2854-X.....27	U5100-XL-75.....41	U5886-X-KK-BLG.....28
U2855-X.....26	U5101-XL-11GR.....40	U5890-X-2/200-BL.....17
U2855-X.....27	U5136-O.....38	U5890-X-2/200-BLG.....17
U2856-X.....26	U5136-O-100S.....38	U5891-X-2/200-MLK-BL.....17
U2856-X.....27	U5136-O-200S.....38	U5898-O-100-KK-BLG.....15
U2862-X.....26	U5137-O-200S.....38	U5898-O-200-KK-BLG.....15
U2862-X.....27	U5161-X-K3L-K2L-BLG.....11	U5902-X-KK-BLG.....28
U2863-X.....26	U5168-XTL-100-KK.....15	U5903-X-KK-BLG.....28
U2863-X.....27	U5168-XTL-100-KK-BLG.....15	U5904-X-KK-BLG.....28
U2864-X.....26	U5168-XTL-150-KK.....15	U5905-X-KK-BLG.....28
U2864-X.....27	U5168-XTL-150-KK-BLG.....15	U5906-X-KK-BLG.....28
U2865-X.....26	U5168-XTL-200-KK.....15	U5971-XL-100.....13
U2865-X.....27	U5168-XTL-200-KK-BLG.....15	U5971-XL-150.....13
U2866-X.....26	U5200-XL.....42	U5971-XL-200.....13
U2866-X.....27	U5200-XL-41.....42	U6115-X-2/200-K7L.....19
U2872-XT.....24	U5200-XL-55.....42	U6227-X-400-K3L.....18
U2873-XT.....24	U5200-XL-75.....42	U6227-X-400-K3L-5T6.....18
U2874-XT.....24	U5220-XL.....42	U6227-X-400-K3L-5T9.....18
U2875-XT.....24	U5220-XL-41.....42	U6228-X-400-K3L.....18
U2876-XT.....24	U5220-XL-55.....42	U6228-X-400-K3L-5T6.....18
U3278-RL.....10	U5220-XL-75.....42	U6228-X-400-K3L-5T9.....18
U3491-XL-200.....14	U5268-XTL-150-KK.....15	U7021-RL-TG-KK.....9
U3802.....6	U5268-XTL-200-KK.....15	U7021-RL-TG-KK-BLG.....9
U3812.....6	U5268-XTL-200-KK-BLG.....15	U7040-RL-TG-KK.....9
U3822-20GWR.....7	U5300-O.....42	U7040-RL-TG-KK-BLG.....9
U3832.....6	U5300-O-41.....42	U7040-XL-TG-KK.....9
U3862.....6	U5300-O-55.....42	U7487-RL-TG-KK.....9
U3989-XL.....14	U5300-O-75.....42	U7487-RL-TG-KK-BLG.....9
U4363-X-QG-K3-K2.....11	U5320-O.....42	U9551-RRL.....10
U4490-XL.....32	U5320-O-41.....42	U9701-RRL.....10
U4492-XL.....32	U5320-O-55.....42	U9701-X-QG-BLG.....10
U4493-XL.....32	U5320-O-75.....42	UAP6094-O.....36
U4532-XL.....9	U5750-RXL-200-BL.....16	UAP6095-O.....36

Please consult serving utility for their requirements prior to ordering or installing, as specifications and approvals vary by utility, and may require local electrical inspector approval. All installations must be installed by a licensed electrician and must comply with all national and local codes, laws and regulations. Milbank reserves the right to make changes in specifications and features shown without notice or obligation.



UAP6096-O .....	36	UQFPH-M-150.....	43
UC1299-RL .....	30	UQFPH-M-175.....	43
UC1300-RL .....	30	UQFPH-M-200.....	43
UC7235-RL .....	30	UQFP-M-100 .....	43
UC7237-XL .....	30	UQFP-M-125 .....	43
UC7444-RL .....	31	UQFP-M-150 .....	43
UC7445-RL .....	31	UQFP-M-175 .....	43
UC7445-RL-641 .....	31	UQFP-M-200 .....	43
UC7445-WL .....	31	USE-22-200-MB .....	13
UC7448-RL .....	31	WBJ2150 .....	44
UC7449-RL .....	31	WBJ2200 .....	44
UC7460-RL .....	31	Z802964-AC .....	47
UC7461-RL .....	31	Z814898-AC .....	47
UC7478-RL .....	31	Z901925-AC .....	47
UC7532-RL .....	31	Z904486-AO .....	47
UC7636-RL .....	31	Z916264-AO .....	47
UQFB-100.....	43	Z916265-AO .....	47
UQFB-100-X1 .....	43		
UQFB-125.....	43		
UQFB-125-X1 .....	43		
UQFB-150.....	43		
UQFB-150-X1 .....	43		
UQFB-175.....	43		
UQFB-175-X1 .....	43		
UQFB-200.....	43		
UQFB-200-X1 .....	43		
UQFBH-100 .....	43		
UQFBH-125 .....	43		
UQFBH-150 .....	43		
UQFBH-175 .....	43		
UQFBH-200 .....	43		
UQFBH-M-100.....	43		
UQFBH-M-125.....	43		
UQFBH-M-150.....	43		
UQFBH-M-175.....	43		
UQFBH-M-200.....	43		
UQFP-100.....	43		
UQFP-125 .....	43		
UQFP-150 .....	43		
UQFP-175 .....	43		
UQFP-200 .....	43		
UQFPH-100 .....	43		
UQFPH-125 .....	43		
UQFPH-150 .....	43		
UQFPH-175 .....	43		
UQFPH-200 .....	43		
UQFPH-M-100.....	43		
UQFPH-M-125.....	43		



Please consult serving utility for their requirements prior to ordering or installing, as specifications and approvals vary by utility, and may require local electrical inspector approval. All installations must be installed by a licensed electrician and must comply with all national and local codes, laws and regulations. Milbank reserves the right to make changes in specifications and features shown without notice or obligation.



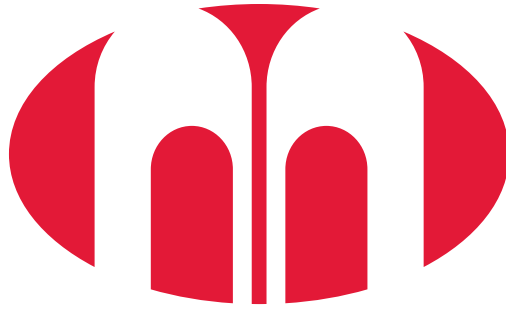

# MILBANK<sup>®</sup>

ENERGY AT WORK

