

**MILBANK**<sup>®</sup>  
ENERGY AT WORK



**Pennsylvania, Delaware,  
South New Jersey, West Virginia Area**  
*Product Catalog*



# Milbank Overview

## *Energy At Work since 1927*

Milbank designs and manufactures electrical solutions that move and manage power for the residential, commercial, industrial, utility and transportation sectors. With 90 years of expertise in electrical engineering design and manufacturing, Milbank's portfolio includes metering equipment, enclosures and enclosed controls. Founded in 1927, Milbank is a family-owned, American manufacturer headquartered in Kansas City, Mo. For more information, please visit [milbankworks.com](http://milbankworks.com).

---

### METERING

---



As a market leader in electrical metering equipment, Milbank has set the standard for quality since 1927. Hundreds of configurations are available, including many sizes, knockout configurations, terminal configurations, bypass options, hubs, locks and connectors. Milbank has the socket you need with thousands of active products to meet your utility's requirements.

---

### ENCLOSURES

---



Milbank's line of enclosures include commercial junction boxes, panel mount enclosures, transformer cabinets, wireway, trough and industrial panel mount and push-button enclosures. Built with high-quality craftsmanship and materials which meet or exceed industry standards, Milbank enclosures are made to protect controls and equipment from dust, dirt and other harmful elements found in a wide variety of environments.

---

### ENCLOSED CONTROLS

---



Milbank doesn't just build empty enclosures. We can deliver the entire package, complete with custom control equipment built to your exact specifications by our engineers. Milbank commercial pedestals are an attractive, secure, easy to install and cost-effective solution when underground remote site power distribution and control equipment is required, replacing unsightly and inefficient strut and backboard structures. Milbank's manual and automatic transfer switches are durable, easy to install and compatible with most generators.



Please consult serving utility for their requirements prior to ordering or installing, as specifications and approvals vary by utility, and may require local electrical inspector approval. All installations must be installed by a licensed electrician and must comply with all national and local codes, laws and regulations. Milbank reserves the right to make changes in specifications and features shown without notice or obligation.

# Table of Contents

## Air Conditioner Disconnects

---

30-60 amp AC disconnects .....	6
60 amp AC disconnect with 20 amp GFCI receptacle .....	7
Hot tub disconnects .....	8

## Single Position Sockets

---

125 amp, 4 & 5 terminal .....	9
200 amp, 4 & 5 terminal .....	10
200 amp, 4 terminal, side wireway .....	11

## Single Position with Lever Bypass

---

200 amp, 5 & 7 terminal .....	12
320 amp, 4 terminal .....	13
320 amp, 5 & 7 terminal .....	14

## Unmetered Power Outlet

---

200 amp.....	15
--------------	----

## Meter Mains with Load Center

---

100-200 amp, 4 terminal .....	16
-------------------------------	----

## Cold Sequence

---

200 amp, 7 terminal, heavy duty lever bypass, ringless .....	17
--	----

## Multi-Position Sockets

---

100 amp, 4 & 5 terminal, ringless .....	18-20
100 amp, 4 terminal, vertical, ringless .....	21
150 amp, 4 terminal .....	22
200 amp, 4 terminal .....	23-25

## Multi-Position Meter Mains

---

125-200 amp, 4 terminal, ringless, 22K .....	26-27
--	-------

## Transformer Rated

---

20 amp, CT Rated socket .....	28
CT Cabinets .....	29

Please consult serving utility for their requirements prior to ordering or installing, as specifications and approvals vary by utility, and may require local electrical inspector approval. All installations must be installed by a licensed electrician and must comply with all national and local codes, laws and regulations. Milbank reserves the right to make changes in specifications and features shown without notice or obligation.



## Meter Main w/ Load Center Pedestal

200 amp, 4 terminal, ringless.....	31
VERSA Ped Information .....	32

## Miscellaneous

Circuit Breakers .....	33-34
Accessories .....	35-37
Utility Approval List .....	38-39
Commercial Pedestals.....	40-49
Commercial and Industrial Enclosures.....	50
Reference Information .....	51-55
Index.....	56

## Utility Abbreviation Explanation

Abbreviation	Utility
ACE	Atlantic City Electric
AEP	American Electric Power
DPL	Delmarva Power
DUQ	Duquesne Light Company
FE	First Energy Utilities
PECO	Philadelphia Electric Company
PPL	PPL Electric Utilities
PSEG	Public Service Electric & Gas



Please consult serving utility for their requirements prior to ordering or installing, as specifications and approvals vary by utility, and may require local electrical inspector approval. All installations must be installed by a licensed electrician and must comply with all national and local codes, laws and regulations. Milbank reserves the right to make changes in specifications and features shown without notice or obligation.

# Catalog Number Logic

How our product catalog numbers are derived

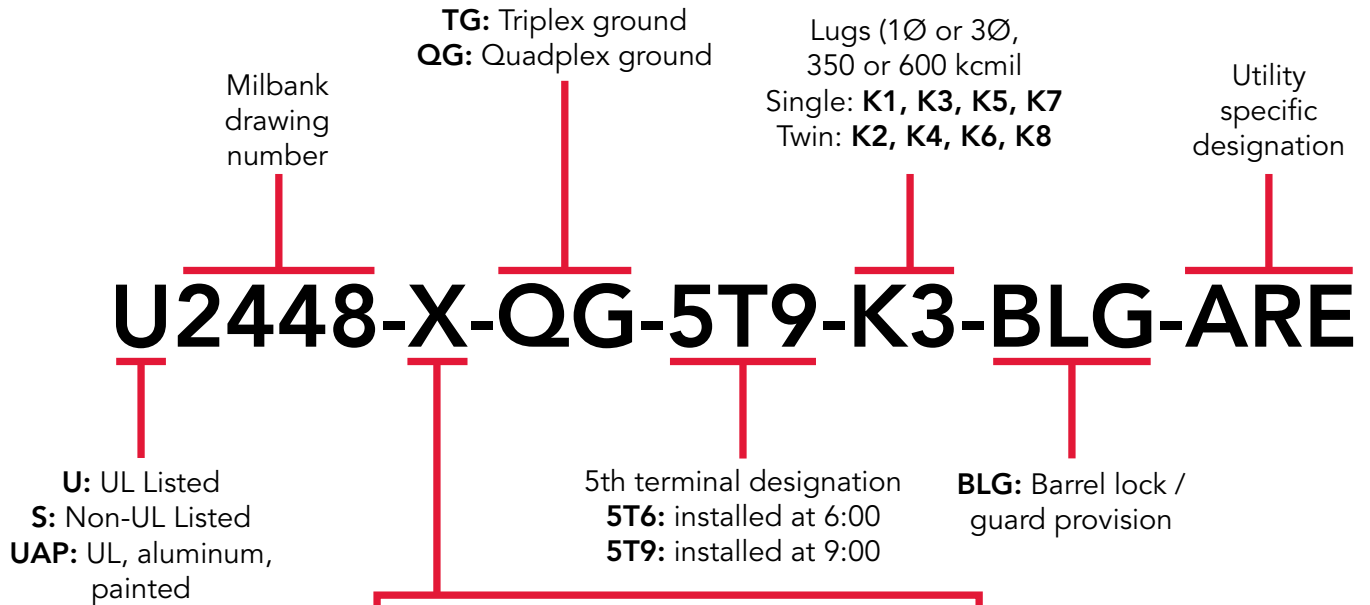

### Hub Openings & Closing Plates

-O	Blank top	-PXL	Closing plate packed inside
-RL	Small hub opening	-WL	1" hub
-R	Large hub opening	-YL	1¼" hub
-XL	Small closing plate	-ZL	1½" hub
-XT	(2) Large Closing plates	-DL	2" hub
-XTL	(2) Small closing plates	-EL	2½" hub
-X	Large closing plate	-F	3" hub
-RXL	Large hub opening adapted to small closing plate	-G	3½" hub
-RRL	Large hub opening adapted to small hub opening	-H	4" hub

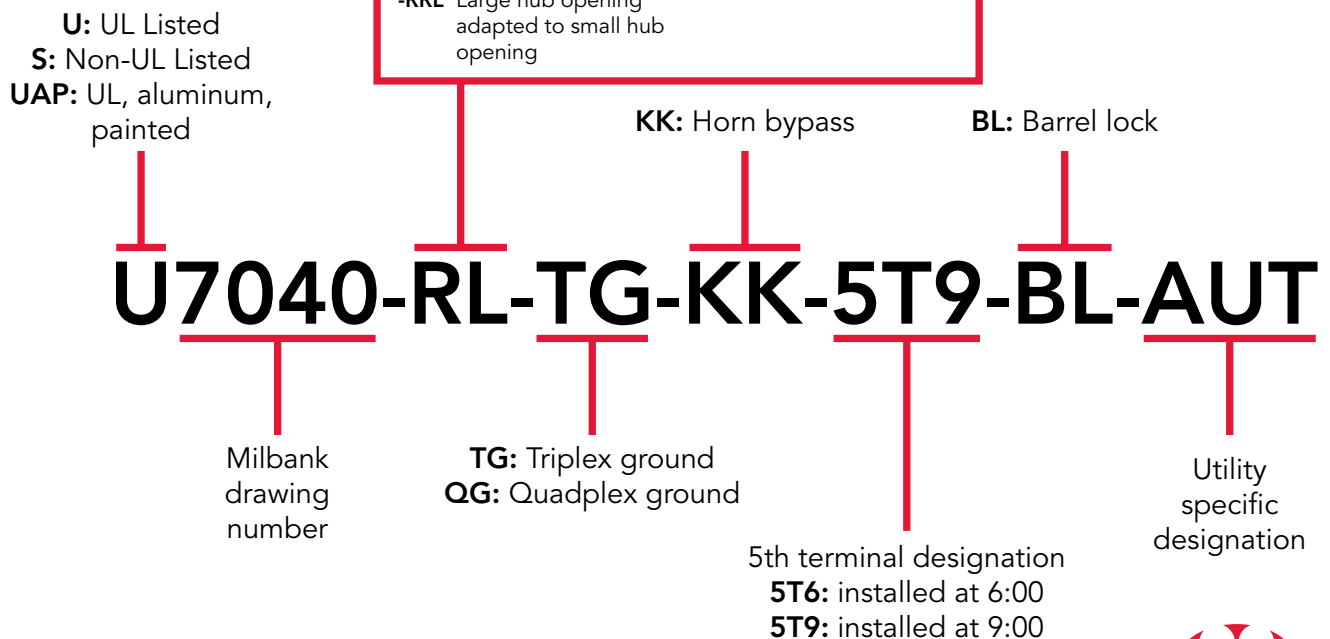

Please consult serving utility for their requirements prior to ordering or installing, as specifications and approvals vary by utility, and may require local electrical inspector approval. All installations must be installed by a licensed electrician and must comply with all national and local codes, laws and regulations. Milbank reserves the right to make changes in specifications and features shown without notice or obligation.



# Air Conditioner Disconnects

30-60 Amp



**U3802**



**U3812**



**U3832**

Milbank's air conditioner disconnect has a removable hinged cover which makes wiring a breeze. Our compact design meets NEC wiring space requirements and also complies with NEC article 440-14. For safe working conditions, our disconnect pullers may be removed and reinstalled in the OFF position. Additionally, padlock provisions are included on the front cover. As with other Milbank products, our enclosure is constructed of G90U galvanized steel and electrostatically finished with an attractive, light gray, baked powder coating. Our epoxy/polyester resin blend offers a finish that is both durable and fade-resistant.

## 30-60 Amp | 1Ø 240 VAC | Air Conditioner Disconnects

Catalog Number	Amp	Type	Max H.P.	Weight (lbs.)	Line/Load Wire Range		Ground Wire Range CU/AL	Dimensions			Wire Rating	
					CU	AL		D"	W"	H"	CU °C	AL °C
<b>U3802</b>	60	Non-Fusible	10	3.25	#14-#2	#12-#2	#14-4	2½	5	7½	60°/75°	60°/75°
<b>U3812</b>	60	Non-Auto	10	3.25	#14-#2	#12-#2	#14-4	2½	5	7½	60°/75°	60°/75°
<b>U3832</b>	30	Fusible	3	2.5	#14-#3	#14-#3	#14-3	2½	5	7	60°/75°	60°
<b>U3862</b>	60	Fusible	10	3.3	#14-#3	#14-#3	#14-3	2½	5	9	60°/75°	60°/75°

### Notes

- UL listed as Enclosed Pullout Switch
- Type 3R rain-resistant
- One-inch concentric knockouts



Please consult serving utility for their requirements prior to ordering or installing, as specifications and approvals vary by utility, and may require local electrical inspector approval. All installations must be installed by a licensed electrician and must comply with all national and local codes, laws and regulations. Milbank reserves the right to make changes in specifications and features shown without notice or obligation.

# Air Conditioner Disconnects

## 60 Amp | With 20 amp GFCI Receptacle



**U3822-20GWR**

### Specifications

- Meets NEC #406.8 requirements
- Meets NEC #210.63 requirements
- UL listed as Power Outlet
- Type 3R enclosure
- In-use cover\*
- Duplex ground connector
- 1" concentric knockouts
- 1Ø, 240 volt
- 60 amp, non-fused
- 20 amp GFCI receptacle
- Reset/test button
- Weather and tamper resistant

### 60 Amp | 1Ø, 240 Volt | Air Conditioner Disconnect with GFCI Receptacle

Catalog Number	Type	Max H.P.	Weight (lbs.)	Line/Load Wire Range		Ground Wire Range CU/AL	Dimensions			Wire Rating	
				CU	AL		D"	W"	H"	CU °C	AL °C
<b>U3822-20GWR</b>	Non-Fusible	10	6	#14-#2	#12-#2	#14-4	4 $\frac{5}{8}$	5 $\frac{1}{4}$	7 $\frac{5}{8}$	60°/75°	60°/75°

### Notes

- **Disconnect Pullers:** To ensure the safest conditions, Milbank disconnect pullers are reversible so they may be reinstalled in the OFF position.
- **Padlock Provision:** All units are designed with a padlock provision on the cover for security.
- **\*In-Use Cover:** Cover is rated as an in-use cover (cover may be closed with cords plugged into receptacle).

Please consult serving utility for their requirements prior to ordering or installing, as specifications and approvals vary by utility, and may require local electrical inspector approval. All installations must be installed by a licensed electrician and must comply with all national and local codes, laws and regulations. Milbank reserves the right to make changes in specifications and features shown without notice or obligation.



# Hot Tub Disconnect

## Type 3R Enclosures



**U4881-O-50GB**



**U4881-O-60GB**

### Specifications

- 240 volt ground fault protection
- UL listed, Type 3R rain-resistant
- 2-pole, 50 amp GFCI breaker protection
- Compact size
- Three or four wire installation
- 1Ø, 120/240 VAC
- Standard package of 12
- Two extra one-pole breaker spaces
- 100 amp overall rating
- Easy to install

### Hot Tub Disconnect or Sub Panel Breaker Enclosure | Type 3R

Catalog Number	Amp	Type	Weight (lbs.)	Line/Load Wire Range		Ground Wire Range CU/AL	Dimensions		
				CU	AL		D"	W"	H"
<b>U4881-O</b>	—	Breaker Provision	7	#14-1/0	#14-1/0	#14-1/0	3¾	7½	8½
<b>U4881-O-50GB</b>	50	Breaker	8	#14-1/0	#14-1/0	#14-1/0	3¾	7½	8½
<b>U4881-O-60GB</b>	60	Breaker	8	#14-1/0	#14-1/0	#14-1/0	3¾	7½	8½



Please consult serving utility for their requirements prior to ordering or installing, as specifications and approvals vary by utility, and may require local electrical inspector approval. All installations must be installed by a licensed electrician and must comply with all national and local codes, laws and regulations. Milbank reserves the right to make changes in specifications and features shown without notice or obligation.



# Single Position Sockets

125 Amp | 4 & 5 Terminal | Ringless | Horn Bypass

**9**  
125 AMP  
SINGLE POSITION  
SOCKETS



U7487-RL-TG-KK-BLG

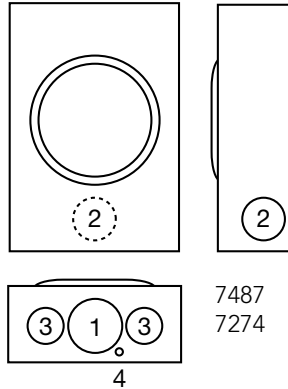

U8569-YL-KK-BLG

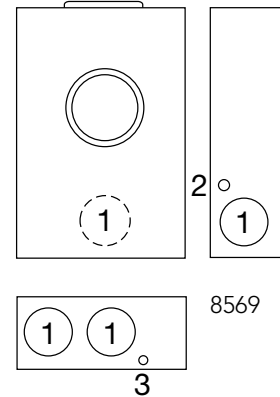

## 125 Amp | Single Position | 4 Terminal | Ringless | 1Ø3W | Horn Bypass

Catalog Number	Amp	Utility Approval	Service	Hub	Connectors CU/AL	Dimensions			Knockouts			
						D"	W"	H"	1	2	3	4
U7274-YL-KK	125	DUQ	OH	1¼	#6-2/0	3⅞	8	11½	2	1½	1¼	¼
U7487-YL-TG-KK-BLG	125	FE, PPL	OH	1¼	#6-2/0	3⅞	8	11½	2	1½	1¼	¼
U7487-RL-TG-KK-BLG	125	FE, AEP, PPL	OH/UG	H.O.	#6-2/0	3⅞	8	11½	2	1½	1¼	¼
U7487-RL-KK-BL	125	PECO	OH/UG	H.O.	#6-2/0	3⅞	8	11½	2	1½	1¼	¼

## 125 Amp | Single Position | 5 Terminal | Ringless | 1Ø3W | Horn Bypass

Catalog Number	Amp	Utility Approval	Service	Hub	Connectors CU/AL	Dimensions			Knockouts			
						D"	W"	H"	1	2	3	4
U8569-YL-KK-BLG*	125	PSEG	OH	1¼	#6-2/0	3⅞	8	11½	1½	7/16	¼	—

### Notes

- **Fifth Terminal:** For field mounted fifth terminal: Order catalog number **5T8K2** to fit into round opening at the 9 o'clock position.
- **Hubs:** For proper hub selection see the hub suffix chart on the accessory page.
- **Connectors** Extruded aluminum connectors are tin plated.
- **Bypass:** Units provided with horn type bypass (suffix **-KK**).
- **Suffix -BLG:** Barrel lock with guard provision.
- **Suffix -BL:** Barrel lock.

\*Lexan @safety shield provided with **U8569-YL-KK-BLG**

Please consult serving utility for their requirements prior to ordering or installing, as specifications and approvals vary by utility, and may require local electrical inspector approval. All installations must be installed by a licensed electrician and must comply with all national and local codes, laws and regulations. Milbank reserves the right to make changes in specifications and features shown without notice or obligation.



# Single Position Sockets

200 Amp | 4 & 5 Terminal | Ringless | Horn Bypass

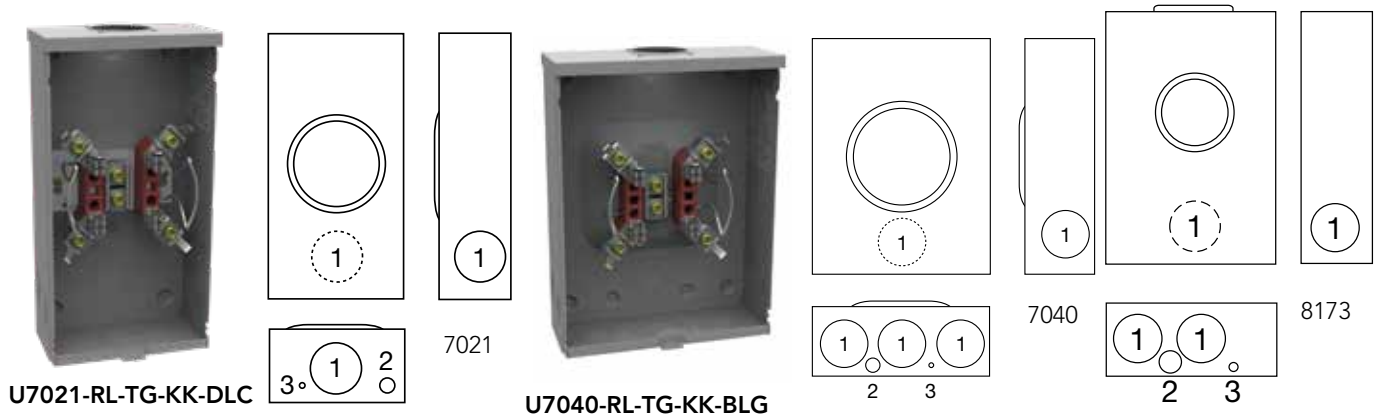

## 200 Amp | Single Position | 4 Terminal | Ringless | 1Ø3W | Horn Bypass

Catalog Number	Utility Approval	Service	Hub	Connectors CU/AL	Dimensions			Knockouts		
					D"	W"	H"	1	2	3
U7021-RL-KK-BL	PECO	OH	H.O.	#6-350 kcmil	4½	8	15½	2½	¼, ½	¼
U7021-RL-KK-DLC	DUQ	OH	H.O.	#6-350 kcmil	4½	8	15½	2½	¼, ½	¼
U7021-RL-TG-KK-BLG	FE, PPL	OH	H.O.	#6-350 kcmil	4½	8	15½	2½	¼, ½	¼
U7040-RL-TG-KK-BLG	AEP	OH	H.O.	#6-350 kcmil	4½	11	15½	2½	2½	¼
U7040-RL-KK-DPL	ACE, DPL	OH	H.O.	#6-350 kcmil	4½	11	15½	2½	2½	¼

## 200 Amp | Single Position | 5 Terminal | Ringless | 1Ø3W | Horn Bypass

Catalog Number	Utility Approval	Service	Hub	Connectors CU/AL	Dimensions			Knockouts		
					D"	W"	H"	1	2	3
U8173-XL-KK-BLG*	PSEG	OH/UG	C.P.	#6-350 kcmil	4½	11	15½	2½	½, ¼	¼

### Notes

- **Fifth Terminal:** For field mounted fifth terminal: Order catalog number **K5T** to fit into square opening at the 9 o'clock position of the new style block (#6-350 kcmil.)
  - **Hubs:** For proper hub selection see the hub suffix chart on the accessory page.
  - **Connectors** Extruded aluminum connectors are tin plated.
  - **Bypass:** Units provided with horn type bypass (suffix **-KK**).
  - **Suffix -BLG:** Barrel lock with guard provision.
  - **Suffix -BL:** Barrel lock.
- \*Lexan @safety shield provided with **U8173-XL-KK-BLG**



Please consult serving utility for their requirements prior to ordering or installing, as specifications and approvals vary by utility, and may require local electrical inspector approval. All installations must be installed by a licensed electrician and must comply with all national and local codes, laws and regulations. Milbank reserves the right to make changes in specifications and features shown without notice or obligation.

# Single Position Side Wireway

200 Amp | 4 Terminal | Side Wireway | Ringless Horn bypass

**1 1**  
200 AMP SINGLE  
POSITION SIDE  
WIREWAY



U1980-O-KK-DPL

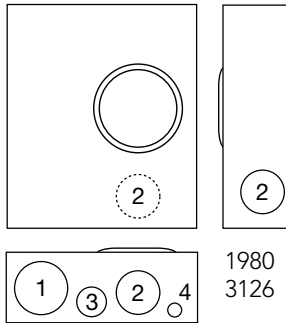

1980  
3126

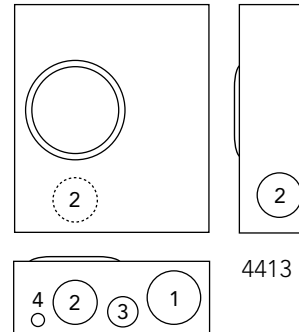

4413

200 Amp | 4 Terminal | Single Position | Horn Bypass | 1Ø3W | Ringless

Catalog Number	Utility Approval	Service	Hub	Connectors CU/AL	Dimensions			Knockouts			
					D"	W"	H"	1	2	3	4
U1980-O-KK-BL	PECO	UG	Blank	#6-350 kcmil	4½	13	15¼	3	2½	1½	¼, ½
U1980-O-KK-DPL	ACE, DPL	UG	Blank	#6-350 kcmil	4½	13	15¼	3	2½	1½	¼, ½
U1980-O-KK-BLG	AEP	UG	Blank	#6-350 kcmil	4½	13	15¼	3	2½	1½	¼, ½
U3126-O-KK-BLG	PPL, FE	UG	Blank	#6-350 kcmil	4½	13	15¼	3	2½	1½	¼, ½
U3126-O-KK-DLC	DUQ	UG	Blank	#6-350 kcmil	4½	13	15¼	3	2½	1½	¼, ½
U4413-O-KK-BLG	FE, PPL	UG	Blank	#6-350 kcmil	4½	13	15¼	3	2½	1½	¼, ½
U4413-O-KK-BL	PECO	UG	Blank	#6-350 kcmil	4½	13	15¼	3	2½	1½	¼, ½
U4413-O-KK-DPL	ACE, DPL	UG	Blank	#6-350 kcmil	4½	13	15¼	3	2½	1½	¼, ½

## Notes

- **Fifth Terminal:** For field mounted fifth terminal: order catalog number **K5T** to fit into square opening at the 9 o'clock position.
- **Connectors** Extruded aluminum connectors are tin plated.
- **Bypass:** Units provided with horn type bypass (suffix **-KK**).
- **Suffix -BLG:** Barrel lock with guard provision.
- **Suffix -BL:** Barrel lock.

Please consult serving utility for their requirements prior to ordering or installing, as specifications and approvals vary by utility, and may require local electrical inspector approval. All installations must be installed by a licensed electrician and must comply with all national and local codes, laws and regulations. Milbank reserves the right to make changes in specifications and features shown without notice or obligation.



# Single Position Lever Bypass

200 Amp | 5 & 7 Terminal | Lever Bypass | Ringless



U7423-RXL

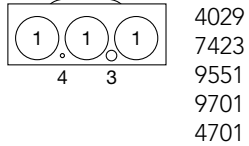
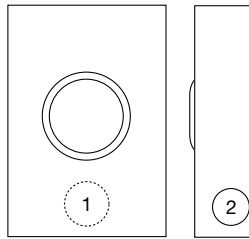

4029  
7423  
9551  
9701  
4701

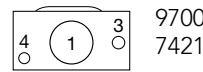
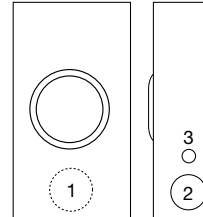

9700  
7421

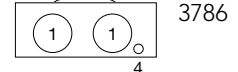
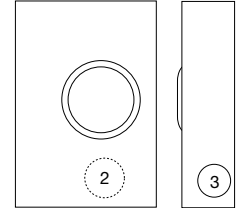

3786

## 200 Amp | 7 Terminal | Medium Duty Lever Bypass | 3Ø4W | Ringless

Catalog Number	No. of Term	Utility Approval	Service	Hub	Connectors CU/AL	Dimensions			Knockouts			
						D"	W"	H"	1	2	3	4
U7421-RRL	7	PPL	OH	H.O.	#6-350 kcmil	4 <sup>7</sup> / <sub>8</sub>	10	18 <sup>1</sup> / <sub>2</sub>	3	2 <sup>1</sup> / <sub>2</sub>	<sup>3</sup> / <sub>4</sub>	<sup>1</sup> / <sub>2</sub> , <sup>1</sup> / <sub>4</sub>
U7423-RXL	7	PECO	OH/UG	C.P.	#6-350 kcmil	4 <sup>7</sup> / <sub>8</sub>	13	19	3	2 <sup>1</sup> / <sub>2</sub>	<sup>1</sup> / <sub>2</sub> , <sup>1</sup> / <sub>4</sub>	<sup>1</sup> / <sub>4</sub>
U4029-X-DPL	7	ACE, DPL	OH/UG	C.P.	#6-350 kcmil	4 <sup>7</sup> / <sub>8</sub>	13	19	3	2 <sup>1</sup> / <sub>2</sub>	<sup>1</sup> / <sub>2</sub> , <sup>1</sup> / <sub>4</sub>	<sup>1</sup> / <sub>4</sub>
U3786-O-BLG	7	FE, PPL	UG	Blank	#6-350 kcmil	6	18	19 <sup>1</sup> / <sub>4</sub>	4	3	2 <sup>1</sup> / <sub>2</sub>	<sup>1</sup> / <sub>2</sub>

## 200 Amp | 5 Terminal | Commercial Lever Bypass | 1Ø3W or 3Ø3W | Ringless

Catalog Number	No. of Term	Utility Approval	Service	Hub	Connectors CU/AL	Dimensions			Knockouts			
						D"	W"	H"	1	2	3	4
U9551-R-5T9	5	FE	OH/UG	H.O.	#6-350 kcmil	4 <sup>7</sup> / <sub>8</sub>	13	19	3	2 <sup>1</sup> / <sub>2</sub>	<sup>1</sup> / <sub>2</sub> , <sup>1</sup> / <sub>4</sub>	<sup>1</sup> / <sub>4</sub>
U9551-X-DPL	5	ACE, DPL	OH/UG	C.P.	#6-350 kcmil	4 <sup>7</sup> / <sub>8</sub>	13	19	3	2 <sup>1</sup> / <sub>2</sub>	<sup>1</sup> / <sub>2</sub> , <sup>1</sup> / <sub>4</sub>	<sup>1</sup> / <sub>4</sub>

## 200 Amp | 7 Terminal | Heavy Duty Lever Bypass | 3Ø4W | Ringless

Catalog Number	No. of Term	Utility Approval	Service	Hub	Connectors CU/AL	Dimensions			Knockouts			
						D"	W"	H"	1	2	3	4
U9700-RRL-BLG	7	FE	OH	H.O.	#6-350 kcmil	4 <sup>7</sup> / <sub>8</sub>	10	18 <sup>1</sup> / <sub>2</sub>	3	2 <sup>1</sup> / <sub>2</sub>	<sup>3</sup> / <sub>4</sub>	<sup>1</sup> / <sub>2</sub> , <sup>1</sup> / <sub>4</sub>
U9701-RRL-BLG*	7	FE, AEP	OH	H.O.	#6-350 kcmil	4 <sup>7</sup> / <sub>8</sub>	13	19	3	2 <sup>1</sup> / <sub>2</sub>	<sup>1</sup> / <sub>2</sub> , <sup>1</sup> / <sub>4</sub>	<sup>1</sup> / <sub>4</sub>
U4701-XL-BLG	7	PSEG	OH/UG	C.P.	#6-350 kcmil	4 <sup>7</sup> / <sub>8</sub>	13	19	3	2 <sup>1</sup> / <sub>2</sub>	<sup>1</sup> / <sub>2</sub> , <sup>1</sup> / <sub>4</sub>	<sup>1</sup> / <sub>4</sub>

### Notes

- **Hubs:** For proper hub selection see the hub suffix chart on the accessory page.
  - **Connectors:** Extruded aluminum connectors are tin plated. **U9551** units include removable bonding strap for isolated neutral.
  - **Bypass:** Medium Duty Lever Bypass is non-jaw clamping.
  - **Bypass:** Heavy Duty Lever supplies clamping action and also operates bypass device.
- \* AEP only OH/UG



Please consult serving utility for their requirements prior to ordering or installing, as specifications and approvals vary by utility, and may require local electrical inspector approval. All installations must be installed by a licensed electrician and must comply with all national and local codes, laws and regulations. Milbank reserves the right to make changes in specifications and features shown without notice or obligation.

# Single Position Heavy Duty Lever Bypass

320 Amp | 4 Terminal | Heavy Duty Lever Bypass | Ringless

**1 3**  
320 AMP  
SINGLE  
POSITION

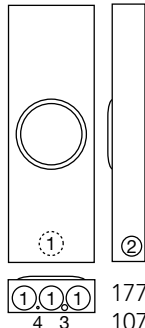

1779  
1079

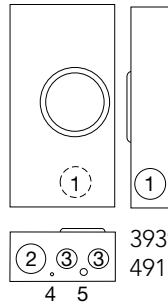

3939  
4912

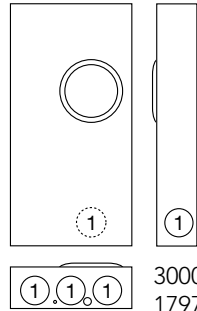

3000  
1797

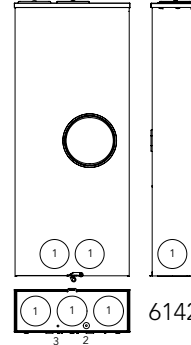

6142

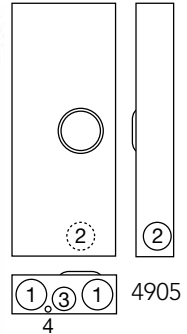

4905

U1779-R-K3-BLG

U1797-O-K3L-K2L-BLG

## 320 Amp | 4 Terminal | Single Position | HD Lever Bypass | 1Ø3W | Ringless

Catalog Number	Utility Approval	Service	Hub	Connectors		Dimensions			Knockouts				
				Line	Load	D"	W"	H"	1	2	3	4	5
U1779-R-K3-BLG	FE, AEP	OH	H.O.	#4-600 kcmil (2) 1/0-250	3/8"-16 stud	4 7/8	13	38 3/4	3	2 1/2	1/4, 1/2	1/4	—
U1079-RRL-K3-BLG	PPL	OH	C.P.	#4-600 kcmil (2) 1/0-250	3/8"-16 stud	4 7/8	13	38 3/4	3 1/2	2 1/2	1/2, 1/4	1/4	—
S6142-X-INV-DPL	ACE, DPL	OH/UG	C.P.	3/8"-16 stud	3/8"-16 stud	5 3/4	16	38 3/4	3 1/2	1/4, 1/2	1/4	—	—
U4905-X-BLG*	AEP	OH/UG	C.P.	3/8"-16 stud	3/8"-16 stud	5 3/4	16	38 3/4	4	3 1/2	3	1/2, 1/4	—
U3939-X*	PPL	UG	C.P.	3/8"-16 stud	3/8"-16 stud	5 3/4	16	30	3 1/2	4	3 1/2	7/8	—
U4912-X-K3-BLG*	FE	UG	C.P.	#4-600 kcmil	3/8"-16 stud	5 3/4	16	30	3 1/2	4	3	1/4	1
U1797-O-K3L-K2L-BLG*	AEP	UG	Blank	#4-600 kcmil (2) 1/0-250	twin #6-350 kcmil	4 7/8	15	30	3	1/4, 1/2	1/4	—	—
U3000-O-2/K3L-BL*	PECO	UG	Blank	#4-600 kcmil (2) 1/0-250	#4-600 kcmil (2) 1/0-250	4 7/8	15	30	3	1/4, 1/2	1/4	—	—

### Notes

- **Fifth Terminal:** For field mounted fifth terminal order **K3865** for **S6142, U3939, U4912, U1797, U3000; K3866** for **U1779** and **U1079**.
- **Hubs:** For proper hub selection see the hub suffix chart on the accessory page.
- **Connectors:** Extruded aluminum connectors are tin plated. For single lug connector kit order as extra: **K1539** (350 kcmil) or **K1540** (600 kcmil). For twin lug connectors are tine plated. For twin lug connectors: **K1350** (350 kcmil). Order two kits to cover both line and load on sockets not supplied with line connectors.
- **Lever Bypass:** Lever bypass supplies clamping action on the meter spades and also operated the bypass device.
- **Suffix -BLG:** Barrel lock with guard provision.
- **Suffix -BL:** Barrel lock.

\*Unit are side bussed

Please consult serving utility for their requirements prior to ordering or installing, as specifications and approvals vary by utility, and may require local electrical inspector approval. All installations must be installed by a licensed electrician and must comply with all national and local codes, laws and regulations. Milbank reserves the right to make changes in specifications and features shown without notice or obligation.



**1 4**  
320 AMP  
SINGLE  
POSITION

# Single Position Heavy Duty Lever Bypass

320 Amp | 5 & 7 Terminal | Heavy Duty Lever Bypass | Ringless



U4367-XPF-BLG

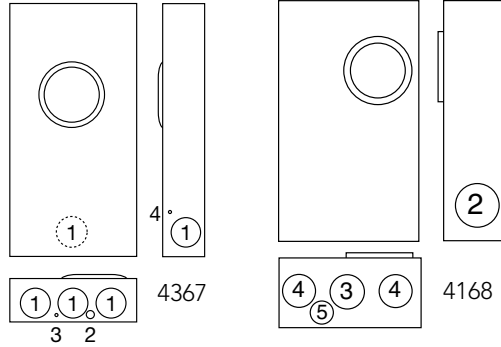

## 320 Amp | 5 & 7 Terminal | Single Position | HD Lever Bypass | Ringless

Catalog Number	No. of Terms	Utility Approval	Service	Hub	Connectors		Dimensions			Knockouts				
					Line	Load	D"	W"	H"	1	2	3	4	5
U4367-XPF-BLG	5	PSEG	OH	C.P.	3/8"-16 stud	3/8"-16 stud	4 7/8	13	28 1/4	3	1/4, 1/2	1/4	7/16	—
U4168-X-K7-BLG*	7	FE, PPL	OH/UG	C.P.	#4-600 kmil (2) 1/0-250	3/8"-16 stud	6 1/2	19	34 1/8	—	3	4	4	1/2

### Notes

- **Hubs:** For proper hub selection see the hub suffix chart on the accessory page.
- **Connectors:** For units supplied with 3/8" – 16 hex head nuts with Belleville washers on line side. Order connector kits on pg 36.
- **Lever Bypass:** Lever bypass supplies clamping action on the meter spades and also operated the bypass device.
- **Barrel Lock:** Barrel lock with guard provision (suffix -BLG).

\* Unit is side bussed.



Please consult serving utility for their requirements prior to ordering or installing, as specifications and approvals vary by utility, and may require local electrical inspector approval. All installations must be installed by a licensed electrician and must comply with all national and local codes, laws and regulations. Milbank reserves the right to make changes in specifications and features shown without notice or obligation.

# Unmetered Power Outlet

200 Amp | 4 Terminal | 120/240 VAC

**15**  
UNMETERED  
POWER  
OUTLET



USE-22-200-MB

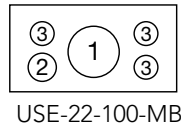
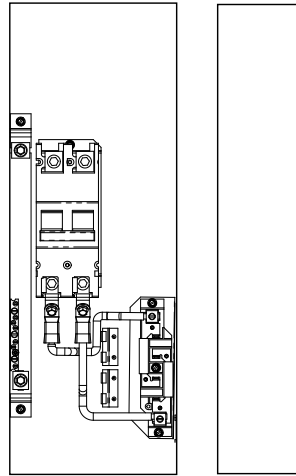

USE-22-100-MB



U5971-XL-200

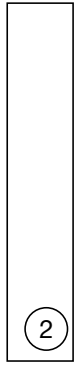
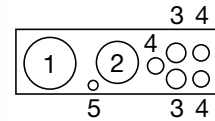
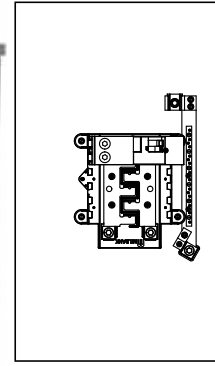

5971

## 200 Amp | 1Ø3W

Catalog Number	Breakers Installed	Service	Branch Circuits	Hub	Connectors	Dimensions			Knockouts				
					Line	D"	W"	H"	1	2	3	4	5
USE-22-200-MB	200	OH	4 Branch	H.O.	2/0-300 kcmil	4	8 $\frac{1}{8}$	22 $\frac{3}{8}$	2	1	1/2, 3/4	—	—
U5971-XL-200	200	OH/UG	8 Branch	C.P.	2/0-300 kcmil	4 $\frac{1}{2}$	14 $\frac{1}{8}$	30	3	2 $\frac{1}{2}$	1	1/2, 3/4	1/2, 1/4

## Notes

- The neutral bus/ground bar is factory installed.
- **USE-22-200-MB:** 200 amp main with provisions for 200 amp direct wire feeder. 200 amp bolt-on-breaker wired in series with plug-in style bus. Space for four single pole or two 2-pole plug-in, branch circuit breakers. Quandplex style breakers may be used in accordance with the NEC.
- **AIC Rating :** The **USE -22-200-MB** has an AIC Rating of 10K. **U5971-XL-200** has an AIC Rating of 22K.

Please consult serving utility for their requirements prior to ordering or installing, as specifications and approvals vary by utility, and may require local electrical inspector approval. All installations must be installed by a licensed electrician and must comply with all national and local codes, laws and regulations. Milbank reserves the right to make changes in specifications and features shown without notice or obligation.



# 16

100-200 AMP  
METER MAIN W/  
LOAD CENTER

# Meter Main With Load Center

200 Amp | 4 Terminal | Ringless | Horn Bypass | 120/240 VAC

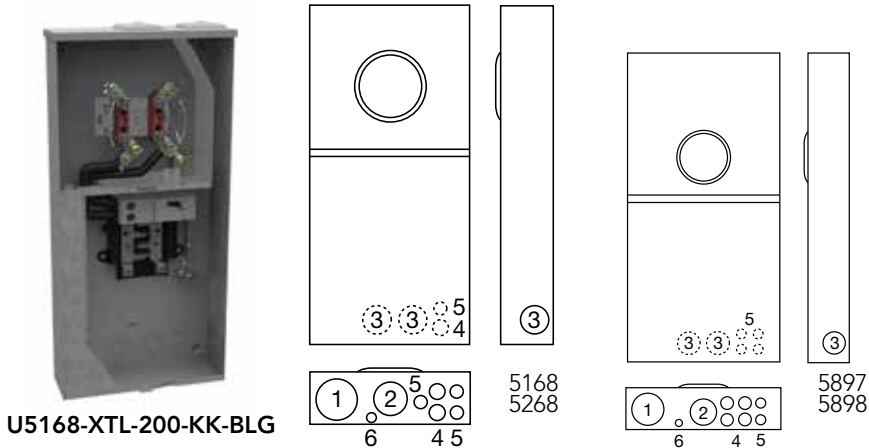

U5168-XTL-200-KK-BLG

## 100-200 Amp | 4 Terminal | Ringless | Horn Bypass

Catalog Number	Utility Approval	Service	Amp	Hub	Connectors		Dimensions			Knockouts					
					Line	Load	D"	W"	H"	1	2	3	4	5	6
U5168-XTL-100-KK-BL	PECO	OH	100	C.P.	#6-350 kcmil	CB	4½	14⅞	30	3	2½	2	1	¾	½
U5168-XTL-100-KK-BLG	FE, PPL, AEP	OH	100	C.P.	#6-350 kcmil	CB	4½	14⅞	30	3	2½	2	1	¾	½
U5168-XTL-200-KK-BL	PECO	OH	200	C.P.	#6-350 kcmil	CB	4½	14⅞	30	3	2½	2	1	¾	½
U5168-XTL-200-KK-BLG	FE, PPL, AEP	OH	200	C.P.	#6-350 kcmil	CB	4½	14⅞	30	3	2½	2	1	¾	½
U5268-XTL-200-KK-BLG*	FE, PPL, AEP	OH	200	C.P.	#6-350 kcmil	CB	4½	14⅞	30	3	2½	2	1	¾	½

## 100-200 Amp | 4 Terminal | Ringless | Horn Bypass

Catalog Number	Utility Approval	Service	Amp	Hub	Connectors		Dimensions			Knockouts					
					Line	Load	D"	W"	H"	1	2	3	4	5	6
U5898-O-100-KK-BLG <sup>1</sup>	FE, PPL, AEP	UG	100	Blank	#6-350 kcmil	CB	4½	17	34½	3	2½	2	1	¾	½
U5898-O-200-KK-BL <sup>1</sup>	PECO	UG	200	Blank	#6-350 kcmil	CB	4½	17	34½	3	2½	2	1	¾	½
U5898-O-200-KK-BLG <sup>1</sup>	FE, PPL, AEP	UG	200	Blank	#6-350 kcmil	CB	4½	17	34½	3	2½	2	1	¾	½

## Notes

- **Hub:** Order hubs as a separate item. See accessory page for hub options.
- **Interior:** U5168, 5897, and 5898 units have 8 circuit interior.
- **Fifth Terminal:** Order K5T and field install for 208Y/120 network systems. Installs in the 9 o'clock position only.
- **Breakers:** Rated 22K AIC with Milbank QN2200RH (200 amp) main installed. For 100 amp units, Q2100H main installed.
- **Interlock Kit:** For generator auxiliary circuit breaker interlock, order K5815 for large QN with small frame Q; order K5820 for large frame QN with large frame QN.
- **Sub-Feed Lugs:** #6-350 kcmil sub-feed lugs provided on 8 circuit interior. **Not available on 20 circuit interior.**
- **Suffix -BLG:** Barrel lock with guard provision.
- **Suffix -BL:** Barrel lock.

\*The U5268 has a 20 circuit load center.

<sup>1</sup> The U5898 has side buss feed.



Please consult serving utility for their requirements prior to ordering or installing, as specifications and approvals vary by utility, and may require local electrical inspector approval. All installations must be installed by a licensed electrician and must comply with all national and local codes, laws and regulations. Milbank reserves the right to make changes in specifications and features shown without notice or obligation.



# Cold Sequence Meter Mains

200 Amp | 7 Terminal | HD Lever Bypass | Ringless

**17**  
200 AMP COLD  
SEQUENCE  
METER MAINS



U5767-X-200-CB

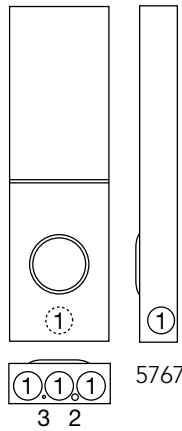

5767



U5787-O-200-CB

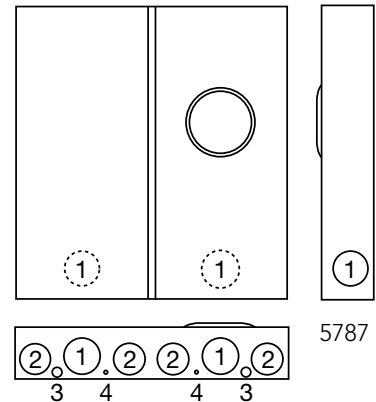

5787

200 Amp | 7 Terminal | Heavy Duty Lever Bypass | 3Ø4W | Ringless

Catalog Number	Amp	Utility Approval	Service	Hub	Connectors CU/AL	Dimensions			Knockouts			
						D"	W"	H"	1	2	3	4
U5767-X-200-CB	200	-	OH	C.P.	#6-350 kcmil	4 <sup>27</sup> / <sub>32</sub>	13	43	3	3	½	¼
U5787-O-200-CB	200	-	UG	Blank	#6-350 kcmil	4 <sup>27</sup> / <sub>32</sub>	26	28	3	2½	½	¼

## Notes

- Circuit Breaker ahead of meter socket.
- Cold Sequence equipment has circuit breaker on line side of meter socket.

Please consult serving utility for their requirements prior to ordering or installing, as specifications and approvals vary by utility, and may require local electrical inspector approval. All installations must be installed by a licensed electrician and must comply with all national and local codes, laws and regulations. Milbank reserves the right to make changes in specifications and features shown without notice or obligation.



# Multi-Position Sockets

100 Amp | 4 Terminal | Horn Bypass | Ringless | 300 VAC



U8212-XL-KK-BLG

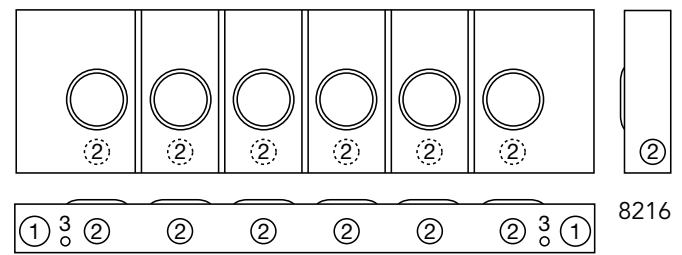
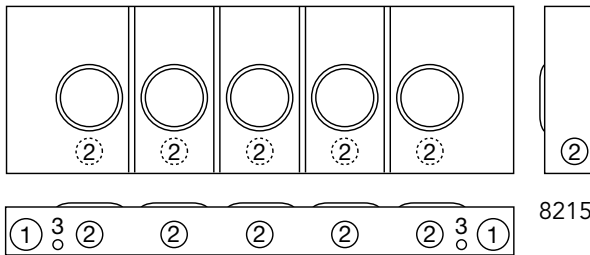
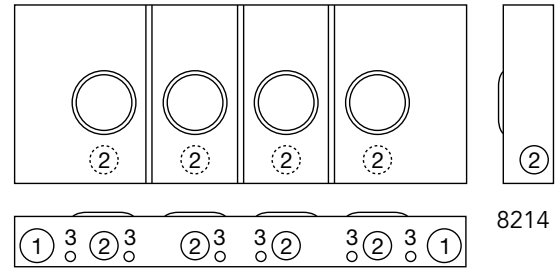
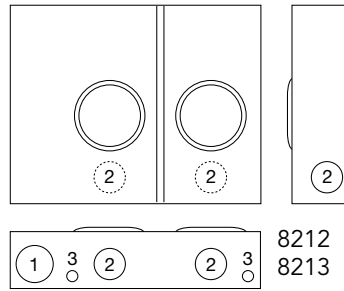

100 Amp | 4 Terminal | Horn Bypass | Ringless | OH/UG | 1Ø3W | End Wireway

Catalog Number	Utility Approval	No. of Positions	Hub	Connectors		Dimensions			Knockouts		
				Line	Load	D"	W"	H"	1	2	3
U8212-XL-KK-BLG	FE, PPL	2	C.P.	6-350 kcmil	#6-2/0	4½	20 <sup>5</sup> / <sub>16</sub>	16	2½	2	¼, ½
U8213-XL-KK-BLG	FE, PPL	3	C.P.	6-350 kcmil	#6-2/0	4½	28½	16	2½	2	¼, ½
U8214-XL-KK-BLG	FE, PPL	4	C.P.	6-350 kcmil	#6-2/0	4½	40 <sup>11</sup> / <sub>16</sub>	16	2½	2	¼, ½
U8215-XL-KK-BLG	FE	5	C.P.	6-350 kcmil	#6-2/0	4½	48 <sup>7</sup> / <sub>8</sub>	16	2½	2	¼, ½
U8216-XL-KK-BLG	FE	6	C.P.	6-350 kcmil	#6-2/0	4½	57 <sup>1</sup> / <sub>16</sub>	16	2½	2	¼, ½

## Notes

- **Hub:** For proper hub selection refer to the hub suffix chart on the accessory page. Hub opening is supplied at each end. Extra openings in top are closed with a closing plate as standard.
- **Fifth Terminal:** For field mounted fifth terminal in six o'clock position, order catalog number **5T8K2** for each meter position. For field mounted fifth terminal in nine o'clock position, order catalog number **K9959** for each meter position.
- **Connectors:** Extruded aluminum connectors are tin plated.
- **Bypass:** Units provided with horn type bypass (suffix -KK).
- **Bussing:** Bussing is 5/16" x 1" aluminum.
- **All units in PPL Utility area are approved for overhead service only.**



Please consult serving utility for their requirements prior to ordering or installing, as specifications and approvals vary by utility, and may require local electrical inspector approval. All installations must be installed by a licensed electrician and must comply with all national and local codes, laws and regulations. Milbank reserves the right to make changes in specifications and features shown without notice or obligation.

# Multi-Position Sockets

100 Amp | 4 & 5 Terminal | Horizontal Gangs | Ringless | 300 VAC

**19**  
100 AMP  
MULTI-POSITION  
SOCKETS



**U8032-XL-KK-BLG**

100 Amp | 4 Terminal | 1Ø3W | Horn Bypass | Ringless | OH/UG | Center Wireway

Catalog Number	Utility Approval	No. of Positions	Hub	Connectors		Dimensions			Knockouts		
				Line	Load	D"	W"	H"	1	2	3
U8032-XL-KK-BLG	FE	2	C.P	6-350 kcmil	#6-2/0	4½	24½	16	2½	2	½
U8032-XL-KK-BL	PECO	2	C.P	6-350 kcmil	#6-2/0	4½	24½	16	2½	2	½
U8033-XL-KK-BLG	FE	3	C.P	6-350 kcmil	#6-2/0	4½	36 <sup>11</sup> / <sub>16</sub>	16	2½	2	½
U8033-XL-KK-BL	PECO	3	C.P	6-350 kcmil	#6-2/0	4½	36 <sup>11</sup> / <sub>16</sub>	16	2½	2	½
U8034-XL-KK-BLG	FE	4	C.P	6-350 kcmil	#6-2/0	4½	40 <sup>7</sup> / <sub>8</sub>	16	2½	2	½
U8034-XL-KK-BL	PECO	4	C.P	6-350 kcmil	#6-2/0	4½	40 <sup>7</sup> / <sub>8</sub>	16	2½	2	½
U8035-XL-KK-BLG	FE	5	C.P	6-350 kcmil	#6-2/0	4½	49 <sup>1</sup> / <sub>16</sub>	16	2½	2	½
U8035-XL-KK-BL	PECO	5	C.P	6-350 kcmil	#6-2/0	4½	49 <sup>1</sup> / <sub>16</sub>	16	2½	2	½
U8036-XL-KK-BLG	FE	6	C.P	6-350 kcmil	#6-2/0	4½	57¼	16	2½	2	½
U8036-XL-KK-BL	PECO	6	C.P	6-350 kcmil	#6-2/0	4½	57¼	16	2½	2	½

100 Amp | 5 Terminal | 1Ø3W | Horn Bypass | Ringless | OH/UG | Center Wireway

Catalog Number	Utility Approval	No. of Positions	Hub	Connectors		Dimensions			Knockouts				
				Line	Load	D"	W"	H"	1	2	3	4	5
U1282-XL-KK-BLG	PSEG	2	C.P.	6-350 kcmil	#6-2/0	4½	24½	14	2½	1½	½	¼	⅙
U1283-XL-KK-BLG	PSEG	3	C.P.	6-350 kcmil	#6-2/0	4½	32 <sup>5</sup> / <sub>8</sub>	14	2½	1½	½	¼	—

## Notes

- **Hubs:** For proper hub selection see the hub suffix chart on the accessory page.
- **Fifth Terminal:** For field mounted fifth terminal, order catalog number **5T8K2** for each meter position, six o'clock position only.
- **Connectors:** Extruded aluminum connectors are tin plated.
- **Bussing:** Bussing is 5/16" 1" aluminum.
- **Bypass:** Units provided with horn type bypass (suffix **-KK**).
- **Suffix -BLG:** Barrel lock with guard provision.
- **Suffix -BL:** Barrel lock.

Please consult serving utility for their requirements prior to ordering or installing, as specifications and approvals vary by utility, and may require local electrical inspector approval. All installations must be installed by a licensed electrician and must comply with all national and local codes, laws and regulations. Milbank reserves the right to make changes in specifications and features shown without notice or obligation.



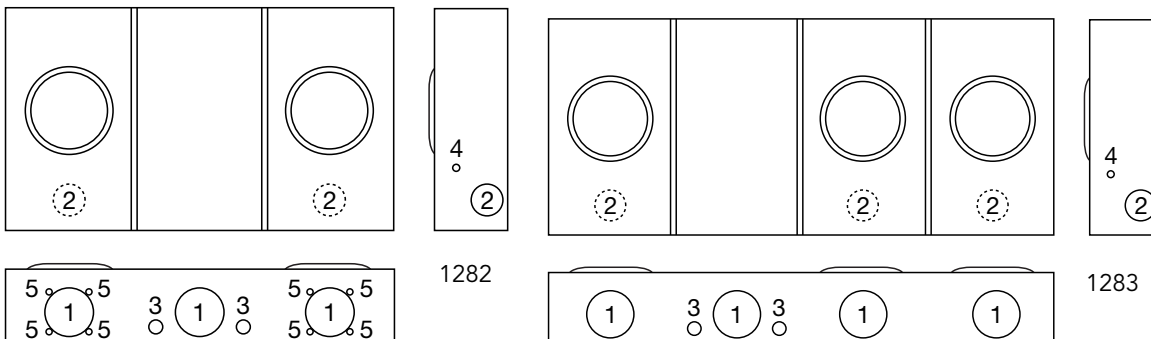
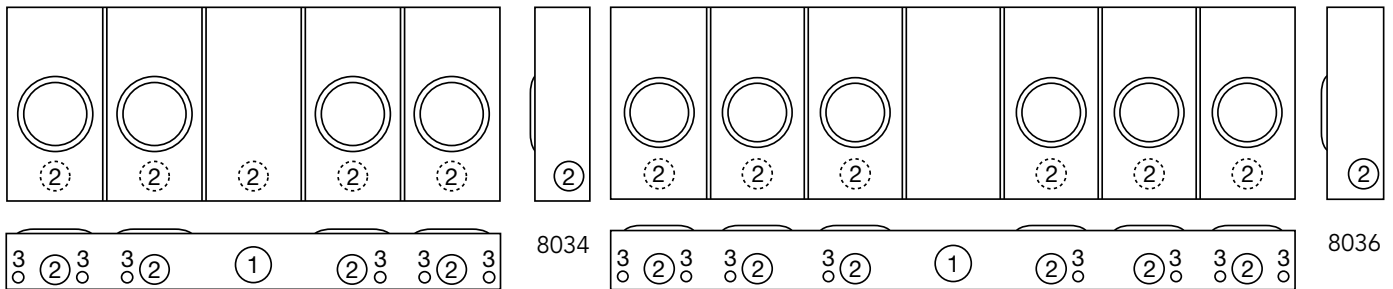
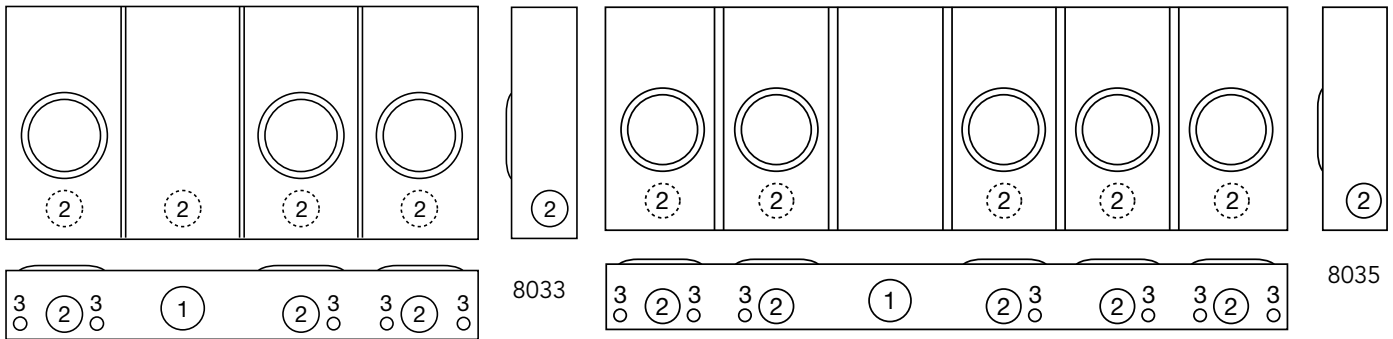
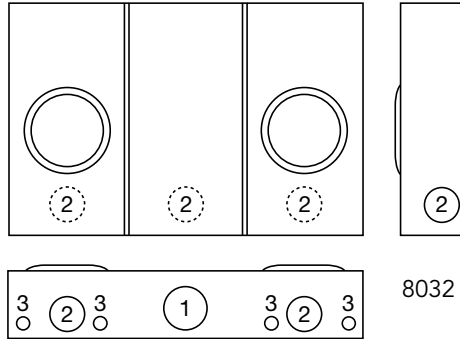

Please consult serving utility for their requirements prior to ordering or installing, as specifications and approvals vary by utility, and may require local electrical inspector approval. All installations must be installed by a licensed electrician and must comply with all national and local codes, laws and regulations. Milbank reserves the right to make changes in specifications and features shown without notice or obligation.

# Vertical Multi-Position Sockets

100 Amp | 4 Terminal | Horn Bypass | Ringless | 300 VAC

**21**  
100 AMP  
VERTICAL  
MULTI-POSITION  
SOCKETS

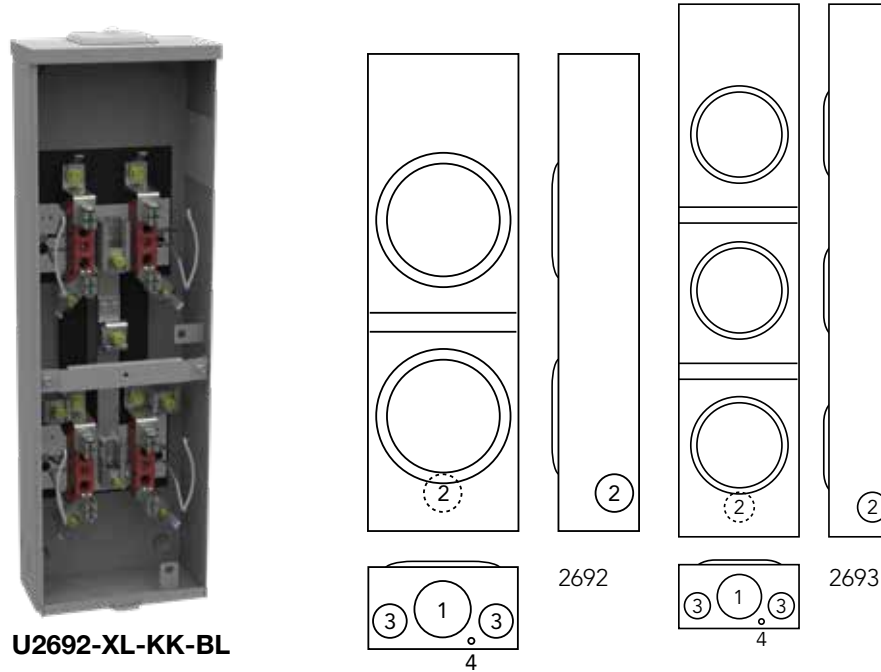

**U2692-XL-KK-BL**

100 Amp | 4 Terminal | Horn Bypass | Ringless | OH/UG

Catalog Number	Utility Approval	No. of Positions	Hub	Connectors		Dimensions			Knockouts			
				Line	Load	D"	W"	H"	1	2	3	4
<b>U2692-XL-KK-BL</b>	PECO	2	C.P.	#2-350 kcmil	#6-2/0	4 $\frac{1}{8}$	8	25 $\frac{1}{4}$	2 $\frac{1}{2}$	1 $\frac{1}{2}$	1 $\frac{1}{4}$	$\frac{1}{4}$
<b>U2693-XL-KK-BL</b>	PECO	3	C.P.	#2-350 kcmil	#6-2/0	4 $\frac{1}{8}$	8	35 $\frac{3}{4}$	2 $\frac{1}{2}$	1 $\frac{1}{2}$	1 $\frac{1}{4}$	$\frac{1}{4}$

## Notes

- **Hub:** For proper hub selection refer to the hub suffix chart on the accessory page. Hub opening is supplied at each end. Extra openings in top are closed with a closing plate as standard.
- **Fifth Terminal:** For field mounted fifth terminal, order catalog number **5T8K2** in 9 o'clock position only.
- **Connectors:** Extruded aluminum connectors are tin plated.
- **Bypass:** Units provided with horn type bypass (suffix **-KK**).
- **Suffix -BL:** Barrel lock.
- **Bussing:** 1/4 x 1" aluminum bussing is supplied. Refer to general engineering section for information on ampacity of bus.

Please consult serving utility for their requirements prior to ordering or installing, as specifications and approvals vary by utility, and may require local electrical inspector approval. All installations must be installed by a licensed electrician and must comply with all national and local codes, laws and regulations. Milbank reserves the right to make changes in specifications and features shown without notice or obligation.



# Multi-Position Sockets

150 Amp | 4 Terminal | Horizontal Gangs | Ringless | 300 VAC



**U9312-XL-KK-DLC**

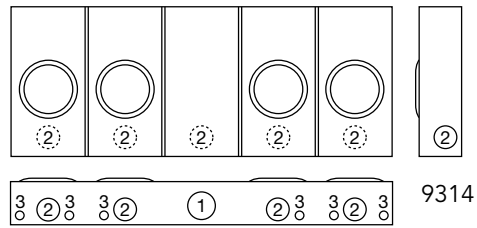
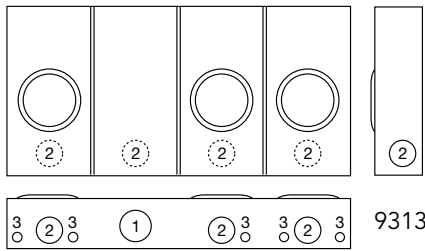
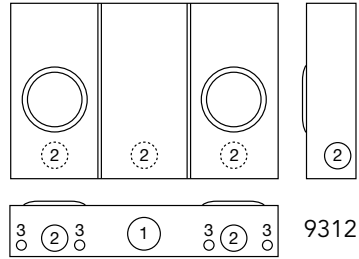

150 Amp | 4 Terminal | 1Ø3W | Horn Bypass | Horizontal Gangs | Ringless | OH/UG | Center Wireway

Catalog Number	Utility Approval	No. of Positions	Hub	Connectors		Dimensions			Knockouts		
				Line	Load	D"	W"	H"	1	2	3
U9312-XL-KK-DLC	DUQ	2	C.P	6-350	kcmil	4½	24½	16	2½	2	½
U9313-XL-KK-DLC	DUQ	3	C.P	6-350	kcmil	4½	32¹¼₆	16	2½	2	½
U9314-XL-KK-DLC	DUQ	4	C.P	6-350	kcmil	4½	40⅞	16	2½	2	½

## Notes

- **Hub:** For proper hub selection see the hub suffix chart on the accessory page.
- **Fifth Terminal:** For field mounted fifth terminal, order catalog number **K5T** for each meter position, six o'clock position only.
- **Connectors:** Extruded aluminum connectors are tin plated.
- **Bypass:** Units provided with horn type bypass (suffix **-KK**).
- **Bussing:** Bussing is 5/16" x 1" aluminum.



Please consult serving utility for their requirements prior to ordering or installing, as specifications and approvals vary by utility, and may require local electrical inspector approval. All installations must be installed by a licensed electrician and must comply with all national and local codes, laws and regulations. Milbank reserves the right to make changes in specifications and features shown without notice or obligation.

# Multi-Position Sockets

200 Amp | 4 Terminal | Horizontal Gangs | Ringless | 300 VAC

**23**  
200 AMP  
MULTI-  
POSITION  
SOCKETS



U1252-X-KK-K3-BLG

200 Amp | 4 Terminal | Horn Bypass | Horizontal Gangs | Ringless | 1Ø3W | OH/UG | Center Wireway

Catalog Number	Utility Approval	No. of Pos.	Hub	Connectors		Dimensions		
				Line	Load	D"	W"	H"
U1252-X-KK-K3-BLG	FE, PPL	2	C.P.	#4-600 kcmil or (2) 1/0-250 kcmil	#6-350 kcmil	5½	26½	14
U1252-X-KK-K3-BL	PECO	2	C.P.	#4-600 kcmil or (2) 1/0-250 kcmil	#6-350 kcmil	5½	26½	14
U1252-X-KK-K3-DPL	ACE, DPL	2	C.P.	#4-600 kcmil or (2) 1/0-250 kcmil	#6-350 kcmil	5½	26½	14
U1253-X-KK-K3-BLG	FE, PPL	3	C.P.	#4-600 kcmil or (2) 1/0-250 kcmil	#6-350 kcmil	5½	34 <sup>11</sup> / <sub>16</sub>	14
U1253-X-KK-K3-BL	PECO	3	C.P.	#4-600 kcmil or (2) 1/0-250 kcmil	#6-350 kcmil	5½	34 <sup>11</sup> / <sub>16</sub>	14
U1254-X-KK-K3-BLG	FE, PPL	4	C.P.	#4-600 kcmil or (2) 1/0-250 kcmil	#6-350 kcmil	5½	42 <sup>7</sup> / <sub>8</sub>	16
U1254-X-KK-K3-BL	PECO	4	C.P.	#4-600 kcmil or (2) 1/0-250 kcmil	#6-350 kcmil	5½	42 <sup>7</sup> / <sub>8</sub>	16
U1254-X-KK-K3-DPL	ACE, DPL	4	C.P.	#4-600 kcmil or (2) 1/0-250 kcmil	#6-350 kcmil	5½	42 <sup>7</sup> / <sub>8</sub>	16
U1255-X-KK-K3-BLG	FE, PPL	5	C.P.	#4-600 kcmil or (2) 1/0-250 kcmil	#6-350 kcmil	5½	54 <sup>7</sup> / <sub>8</sub>	16
U1255-X-KK-K3-BL	PECO	5	C.P.	#4-600 kcmil or (2) 1/0-250 kcmil	#6-350 kcmil	5½	54 <sup>7</sup> / <sub>8</sub>	16
U1256-X-KK-K3-BLG	FE, PPL	6	C.P.	#4-600 kcmil or (2) 1/0-250 kcmil	#6-350 kcmil	5½	63 <sup>3</sup> / <sub>16</sub>	16
U1256-X-KK-K3-BL	PECO	6	C.P.	#4-600 kcmil or (2) 1/0-250 kcmil	#6-350 kcmil	5½	63 <sup>3</sup> / <sub>16</sub>	16
U1256-X-KK-K4-DPL	ACE, DPL	6	(2)C.P.	#4-600 kcmil	#6-350 kcmil	5½	63 <sup>3</sup> / <sub>16</sub>	16

## Notes

- **Hub:** For proper hub selection refer to the hub suffix chart on the accessory page. For the **U1255-1256** units, two hub openings are supplied and the extra opening is closed with a closing plate as standard.
- **Fifth Terminal:** For field mounted fifth terminal, order catalog number **K5T** for each meter position, 9 o'clock position only.
- **Connectors:** Extruded aluminum connectors are tin plated.
- **Bypass:** Units provided with horn type bypass (suffix **-KK**).
- **Suffix -BLG:** Barrel lock with guard provision.
- **Suffix -BL:** Barrel lock.
- **Bussing:** Bussing is 5/16" x 1" aluminum on the **U1252-1253**. On the **U1254-6** gangs the bussing is 3/8" x 1" aluminum. Knockout information is on the following page.

Please consult serving utility for their requirements prior to ordering or installing, as specifications and approvals vary by utility, and may require local electrical inspector approval. All installations must be installed by a licensed electrician and must comply with all national and local codes, laws and regulations. Milbank reserves the right to make changes in specifications and features shown without notice or obligation.



Knockouts				
1	2	3	4	5
3	2½	1	½	¼

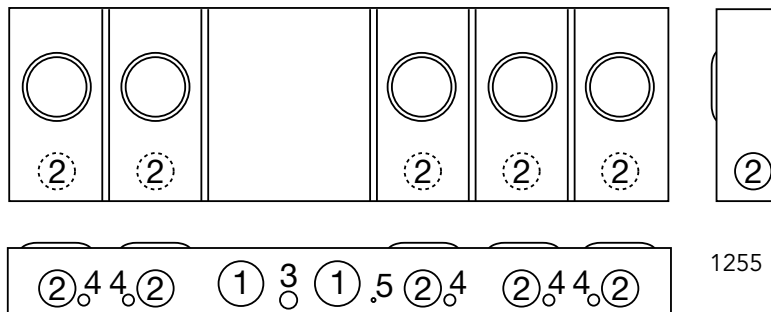
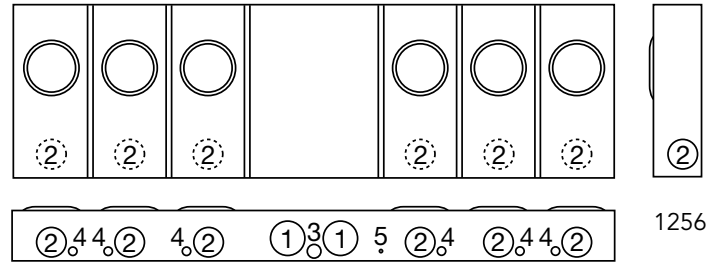
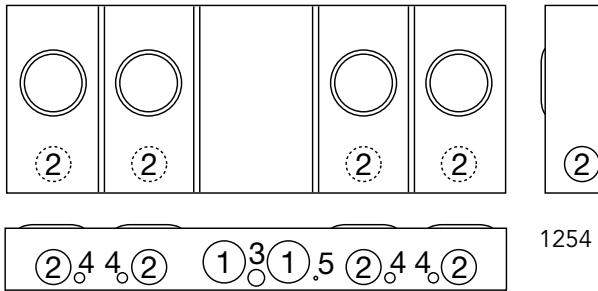
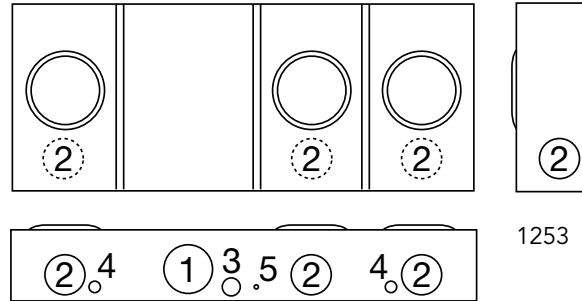
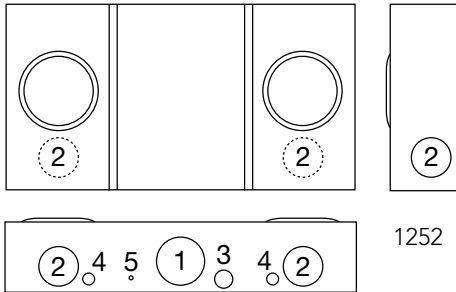

Please consult serving utility for their requirements prior to ordering or installing, as specifications and approvals vary by utility, and may require local electrical inspector approval. All installations must be installed by a licensed electrician and must comply with all national and local codes, laws and regulations. Milbank reserves the right to make changes in specifications and features shown without notice or obligation.



# Multi-Position Sockets

200 Amp | 4 Terminal | Horn Bypass | Ringless | 300 VAC

**25**  
200 AMP  
HORN BYPASS  
METER MAINS



**U1252-RRL-KK-K1-BLG-SLVG**

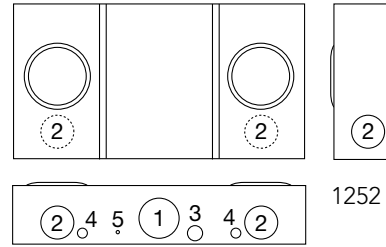

1252

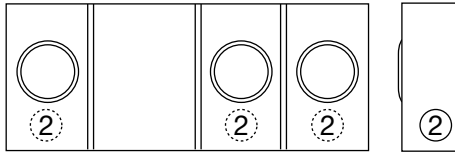

1253

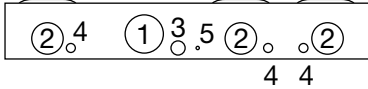

4 4

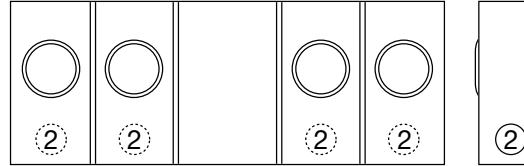

1254

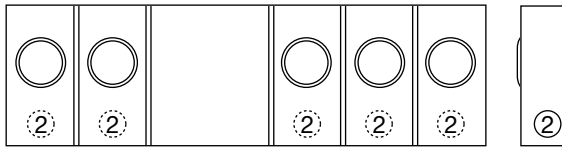
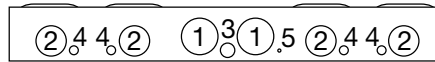

1255

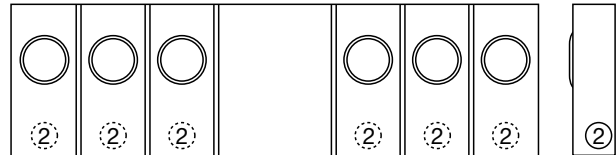
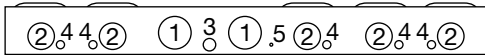

1256

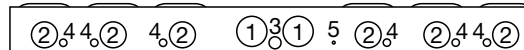

200 Amp | 4 Terminal | Horn Bypass | Ringless | 1Ø3W | OH/UG

Catalog Number	Utility Approval	No. of Pos	Hub	Connectors		Deminsions			Knockouts				
				Line	Load	D"	W"	H"	1	2	3	4	5
<b>U1252-RRL-KK-K1-BLG-SLVG</b>	AEP	2	C.P.	#6-350	#6-350	5½	26½	14	3	2½	1	½	¼
<b>U1252-X-KK-K3-DLC</b>	DUQ	2	C.P.	#4-600	#6-350	5½	26½	14	3	2½	1	½	¼
<b>U1253-RRL-KK-K1-BLG-SLVG</b>	AEP	3	C.P.	#6-350	#6-350	5½	34½	14	3	2½	1	½	¼
<b>U1253-X-KK-K3-DLC</b>	DUQ	3	C.P.	#4-600	#6-350	5½	34½	14	3	2½	1	½	¼
<b>U1254-RXL-KK-K1-BLG-SLVG</b>	AEP	4	C.P.	#6-350	#6-350	5½	42½	16	3	2½	1	½	¼
<b>U1254-X-KK-K3-DLC</b>	DUQ	4	C.P.	#4-600	#6-350	5½	42½	16	3	2½	1	½	¼
<b>U1255-RXL-KK-K1-BLG-SLVG</b>	AEP	5	C.P.	#6-350	#6-350	5½	54½	16	3	2½	1	½	¼
<b>U1255 X-KK-K3-DLC</b>	DUQ	5	C.P.	#6-350	#6-350	5½	54½	16	3	2½	1	½	¼
<b>U1256-RXL-KK-K1-BLG-SLVG</b>	AEP	6	C.P.	#6-350	#6-350	5½	62½	18	3	2½	1	½	¼
<b>U1256-X-KK-K3-DLC</b>	DUQ	6	C.P.	#6-350	#6-350	5½	62½	18	3	2½	1	½	¼

## Notes

- **Hubs:** For proper hub selection, refer to the hub suffix chart on the accessories page. For the **U1254-6** two hub openings are supplied and the extra opening is closed with a closing plate as standard.
- **Fifth Terminal:** For field mounted fifth terminal, order catalog number **K5T** (9 o'clock position).

Please consult serving utility for their requirements prior to ordering or installing, as specifications and approvals vary by utility, and may require local electrical inspector approval. All installations must be installed by a licensed electrician and must comply with all national and local codes, laws and regulations. Milbank reserves the right to make changes in specifications and features shown without notice or obligation.



# Multi-Position Meter Mains

125-200 Amp | 4 Terminal | Ringless | 120/240 VAC | 22K AIC



U5902-X-KK-BL

## 125-200 Amp | 4 Terminal | Ringless

Catalog Number	Amp	Utility Approval	No. of Pos.	Hub	Connectors	Diminsions			Knockouts				
					Line	D"	W'	H"	1	2	3	4	5
U5902-X-KK-BL	125	PECO	2	C.P.	3/8" x 16 Stud	5 1/8	26 1/2	30	3	2 1/2	1	7/8	1/4
U5902-X-KK-BLG	125	AEP, PPL	2	C.P.	3/8" x 16 Stud	5 1/8	26 1/2	30	3	2 1/2	1	7/8	1/4
U5903-X-KK-BL	125	PECO	3	C.P.	3/8" x 16 Stud	5 1/8	34 1/16	30	3	3	2 1/2	1	—
U5903-X-KK-BLG	125	AEP, PPL	3	C.P.	3/8" x 16 Stud	5 1/8	34 1/16	30	3	3	2 1/2	1	—
U5904-X-KK-BL	125	PECO	4	C.P.	3/8" x 16 Stud	5 1/8	42 13/16	30	3	3	2 1/2	1	—
U5904-X-KK-BLG	125	AEP, PPL	4	C.P.	3/8" x 16 Stud	5 1/8	42 13/16	30	3	3	2 1/2	1	—
U5905-X-KK-BL	125	PECO	5	C.P.	3/8" x 16 Stud	5 1/8	51 1/16	30	3	3	2 1/2	1	—
U5905-X-KK-BLG	125	AEP, PPL	5	C.P.	3/8" x 16 Stud	5 1/8	51 1/16	30	3	3	2 1/2	1	—
U5906-X-KK-BL	125	PECO	6	C.P.	3/8" x 16 Stud	5 1/8	59 5/16	30	3	3	2 1/2	1	—
U5906-X-KK-BLG	125	AEP, PPL	6	C.P.	3/8" x 16 Stud	5 1/8	59 5/16	30	3	3	2 1/2	1	—
U5882-X-KK-BL	200	PECO	2	C.P.	3/8" x 16 Stud	5 1/8	59 5/16	30	3	2 1/2	1	7/8	1/4
U5882-X-KK-BLG	200	AEP, PPL	2	C.P.	3/8" x 16 Stud	5 1/8	59 5/16	30	3	2 1/2	1	7/8	1/4
U5883-X-KK-BL	200	PECO	3	C.P.	3/8" x 16 Stud	5 1/8	34 1/16	30	3	2 1/2	2 1/2	1	—
U5883-X-KK-BLG	200	AEP, PPL	3	C.P.	3/8" x 16 Stud	5 1/8	34 1/16	30	3	2 1/2	2 1/2	1	—
U5884-X-KK-BL	200	PECO	4	C.P.	3/8" x 16 Stud	5 1/8	42 13/16	30	3	2 1/2	2 1/2	1	—
U5884-X-KK-BLG	200	AEP, PPL	4	C.P.	3/8" x 16 Stud	5 1/8	42 13/16	30	3	2 1/2	2 1/2	1	—
U5885-X-KK-BL	200	PECO	5	C.P.	3/8" x 16 Stud	5 1/8	51 1/16	30	3	2 1/2	2 1/2	1	—
U5885-X-KK-BLG	200	AEP, PPL	5	C.P.	3/8" x 16 Stud	5 1/8	51 1/16	30	3	2 1/2	2 1/2	1	—
U5886-X-KK-BL	200	PECO	6	C.P.	3/8" x 16 Stud	5 1/8	59 5/16	30	3	2 1/2	2 1/2	1	—
U5886-X-KK-BLG	200	AEP, PPL	6	C.P.	3/8" x 16 Stud	5 1/8	59 5/16	30	3	2 1/2	2 1/2	1	—

### Notes

- **Hub:** For proper hub selection refer to the hub suffix chart on the accessory page.
- **Fifth Terminal:** For field mounted fifth terminal, order catalog number **K5T** for each meter position, 9 o'clock position.
- **Connectors:** Extruded aluminum connectors are tin plated.
- **Bypass:** Units provided with horn type bypass (suffix **-KK**).
- **Suffix -BLG:** Barrel lock with guard provision.
- **Suffix -BL:** Barrel lock.



Please consult serving utility for their requirements prior to ordering or installing, as specifications and approvals vary by utility, and may require local electrical inspector approval. All installations must be installed by a licensed electrician and must comply with all national and local codes, laws and regulations. Milbank reserves the right to make changes in specifications and features shown without notice or obligation.

# U5902-06 & U5882-86 Series

## Knockout Information

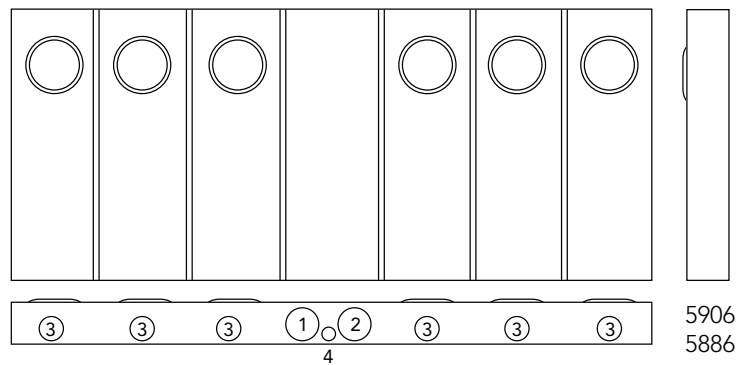
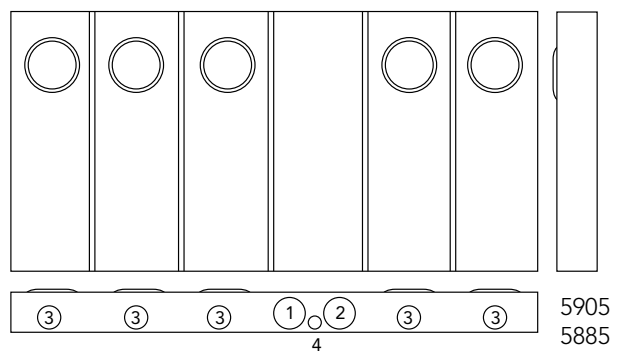
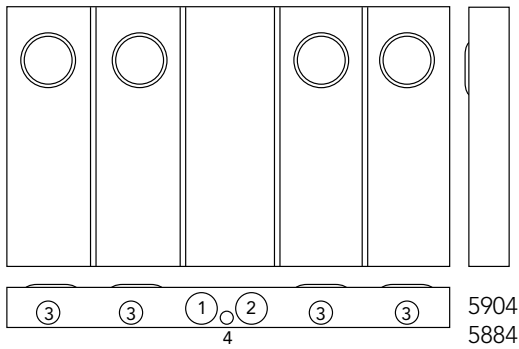
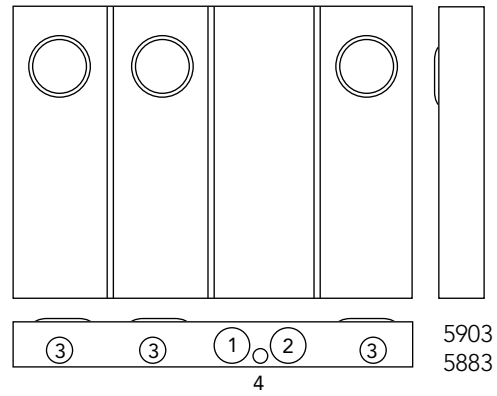
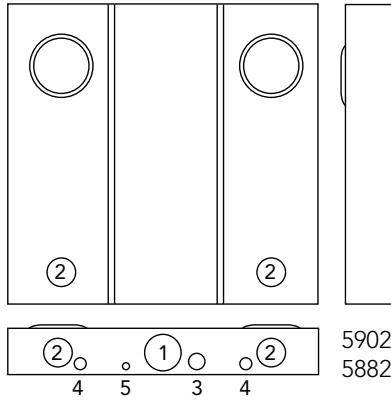

Please consult serving utility for their requirements prior to ordering or installing, as specifications and approvals vary by utility, and may require local electrical inspector approval. All installations must be installed by a licensed electrician and must comply with all national and local codes, laws and regulations. Milbank reserves the right to make changes in specifications and features shown without notice or obligation.



# 28

20 AMP CURRENT  
TRANSFORMER  
RATED SOCKET

# Current Transformer Rated Sockets

20 Amp CT Rated Socket

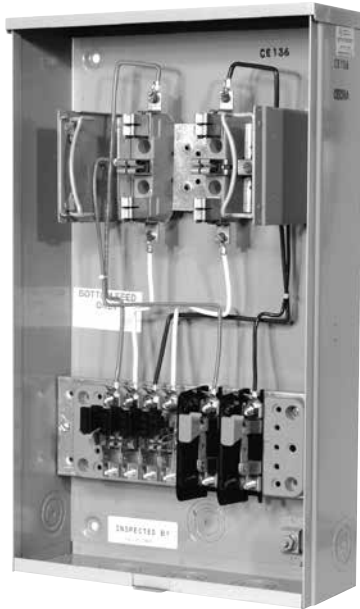

CE136-CECHA

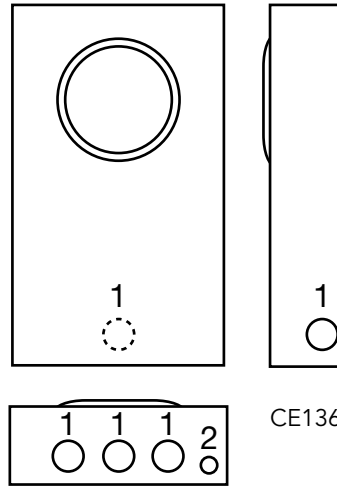

CE136

## 20 Amp Test Switch | 6 Terminal | 1Ø

Catalog Number	Utility Approval	Service	Dimensions			Knockouts	
			D"	W"	H"	1	2
CE136-CECHA	PECO	UG	4 <sup>7</sup> / <sub>8</sub>	12	20	1 <sup>1</sup> / <sub>4</sub>	1 <sup>1</sup> / <sub>4</sub> , 1 <sup>1</sup> / <sub>2</sub>



Please consult serving utility for their requirements prior to ordering or installing, as specifications and approvals vary by utility, and may require local electrical inspector approval. All installations must be installed by a licensed electrician and must comply with all national and local codes, laws and regulations. Milbank reserves the right to make changes in specifications and features shown without notice or obligation.

# Current Transformer Cabinets



**Features:** Supplied with studs, three point locking handle, continuous hinge and pad-lock provision. single door provided on units less than 36" wide. Steel panels and plywood backboard are optional.

**Note:** Other size of Outdoor Transformer Cabinets are available. Please refer to the Milbank Commercial Electrical Enclosure catalog, featuring NEMA-rated sheet metal products.

Catalog Number	Utility Approval	Gauge of Steel	Dimensions			CT Mounting Provision
			D"	W"	H"	
U5990-O*	FE	12	10	36	36	CT mounting rack included

Catalog Number	Utility Approval	Gauge of Steel	Dimensions			Panel Size	
			D"	W"	H"	W" x H"	
182410-CTC1-SP	PECO	14	10	24	18	20	14
243210-CTC1-SP	PECO	14	10	32	24	28	20
323210-CTC1-SP	PECO	12	10	32	32	28	28
324210-CTC1-SP	PECO	12	10	42	32	38	28
425412-CTC1-SP	PECO	12	12	54	42	50	38
281815-CT3R-SP	PECO	14	15	28	18	24	14
303515-CT3R-SP	PECO	14	15	30	35	26	31
324215-CT3R-SP	PECO	12	15	32	42	28	38
403515-CT3R-SP	PECO	12	15	40	35	36	31
544215-CT3R-SP	PECO	12	15	54	42	50	38

Catalog Number	Utility Approval	Gauge of Steel	Dimensions			Panel & Backboard Catalog Numbers	
			D"	W"	H"	Steel	Wood
363612-LC3R-SP-WB	AEP	14	14.3	36	36	A-36P36	A-36P36W
484812-CT3R-WB	AEP	14	12	48	48	—	Included
606015-CT3R-WB	AEP	12	15	60	60	—	Included
484812-CT3R-SP**	PPL	14	12	48	48	—	—

\*C.T. Mounting rack: this unit accommodates 3 donut style C.T.s. Removable cover for easier wiring.

\*\*Double door units

Please consult serving utility for their requirements prior to ordering or installing, as specifications and approvals vary by utility, and may require local electrical inspector approval. All installations must be installed by a licensed electrician and must comply with all national and local codes, laws and regulations. Milbank reserves the right to make changes in specifications and features shown without notice or obligation.





# Meter Main with Load Center Pedestal

200 Amp | 4 Terminal | Ringless | 120/240 VAC

**3 1**  
METER MAIN  
WITH LOAD  
CENTER  
PEDESTAL



U5136-O-200S

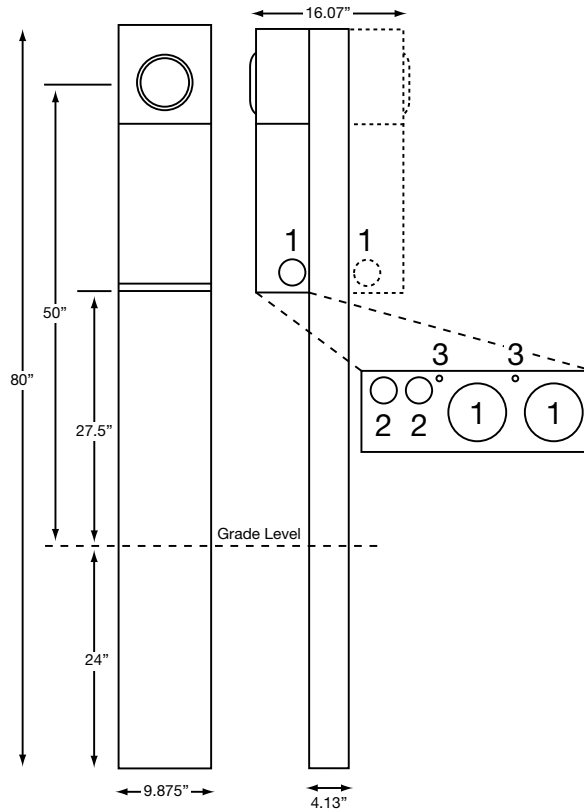

## Specifications

- UL listed file **E90945**.
- 200 amp maximum, 120/240 volt, single phase, three wire meter socket.
- Ringless meter socket with Horn bypass and stainless steel latch.
- Short circuit withstand rating **22K AIC**.
- Type 3R construction for durable outdoor use, one piece past - lockable and sealable.
- Milbank grey polyester powder coat finish.
- Wire terminations accept copper or aluminum conductors.
- Line & Neutral: (2) #6-350 kcmil per phase.
- Line Ground: (4) #14-1/0.
- Load (CB): 200 amp breaker - 2/0 to 300 kcmil per pole. 100 amp breaker - #3-#1 CU or #1-1/0 AL.
- Load Neutral: (1) #6-350 kcmil.
- Load Ground: (2) #14-1/0, (4) #14/6.
- Milbank plug-in main circuit breaker. Available in 100, 125, 150 & 200 amp. Type UQFPH-M.
- Four-circuit plated copper interior accepts (2) 2-pole or (4) 1-pole standard plug-in type circuit breakers up to a total of 125 amp maximum. Acceptable manufacturers: Cutler-Hammer, GE or Siemens.
- Factory or field installable bridge and receptacle/circuit breaker parts available. See accessories.

Please consult serving utility for their requirements prior to ordering or installing, as specifications and approvals vary by utility, and may require local electrical inspector approval. All installations must be installed by a licensed electrician and must comply with all national and local codes, laws and regulations. Milbank reserves the right to make changes in specifications and features shown without notice or obligation.



### Single Pedestal (Direct Burial)

Util App	Catalog Number	Main Breaker	Main BC	Branch	Weight (lbs)
FE-PPL	U5136-O-100S	UQFPH-M-100 Series	100	4 Circuit	82
FE-PPL	U5136-O-200S	UQFPH-M-200 Series	200	4 Circuit	82
	U5136-O (parallel wired)	provision for UQFPH-M		4 Circuit	80

### Double Pedestal (Direct Burial)

Util App	Catalog Number	Main Breaker	Main BC	Branch	Weight (lbs)
FE-PPL	U5137-O-100S	(2) UQFPH-M-100 Series	100	4 Circuit	115
FE-PPL	U5137-O-200S	(2) UQFPH-M-200 Series	200	4 Circuit	115
	U5137-O (parallel wired)	provision for (2) UQFPH-M		4 Circuit	111

<b>K5400-BRIDGE-1POS</b>	Self-grounded one position receptacle bridge with hardware
<b>K5400-BRIDGE-2POS</b>	Self-grounded two position receptacle bridge with hardware
<b>K5415</b>	Stabilizer Foot with hardware (Required for all FE & PPL direct bury applications)
<b>K5T</b>	5th Terminal for 208y/120 volt 3-wire service
<b>K5193</b>	Bus kit to convert series-wired main breaker to parallel
<b>K5194</b>	Wire kit to convert parallel-wired main breaker to series
<b>K3450</b>	Telephone/CATV mounting bracket (mounts left to right)

## Specifications

- Up to two receptacle/circuit breaker kits can be field-installed in each powerhead. Order mounting bridge and receptacle kits separately from above. For three receptacles or factory-installed kits, contact factory.
- Receptacle/circuit breaker kits include receptacle, circuit breaker, connected wire, cover plate and mounting screws. Other receptacle/circuit breaker kits available.
- **K5415** Stabilizer foot sold separately. Recommended for double pedestals. **K5415 required for all FE & PPL direct bury applications.**
- For pad mount pedestals, contact factory for details.
- Stock item - availability subject to prior sale.



Please consult serving utility for their requirements prior to ordering or installing, as specifications and approvals vary by utility, and may require local electrical inspector approval. All installations must be installed by a licensed electrician and must comply with all national and local codes, laws and regulations. Milbank reserves the right to make changes in specifications and features shown without notice or obligation.



# Circuit Breakers

UQFP Plug-In & UQFB Bolt-On Series | 120/240 VAC



UQFP  
UQFPH



UQFP-M  
UQFPH-M



UQFB-X1



UQFBH

## 200 Amp Frame | Plug-In | 10,000 AIC & 22,000 AIC | Two-Pole - Common Trip

Amp	10K AIC Plug-In	22K AIC Plug-In	10K AIC Plug-In	22K AIC Plug-In	Wire Range	
					CU	AL
100	UQFP-100	UQFPH-100	UQFP-M-100	UQFPH-M-100	#3-#1	#1-1/0
125	UQFP-125	UQFPH-125	UQFP-M-125	UQFPH-M-125	#3-#1	#1-1/0
150	UQFP-150	UQFPH-150	UQFP-M-150	UQFPH-M-150	1/0-300	2/0-300
175	UQFP-175	UQFPH-175	UQFP-M-175	UQFPH-M-175	1/0-300	2/0-300
200	UQFP-200	UQFPH-200	UQFP-M-200	UQFPH-M-200	1/0-300	2/0-300

## 200 Amp Frame | Bolt-On | 10,000 AIC & 22,000 AIC | Two-Pole - Common Trip

Amp	10K AIC Bolt-On	22K AIC Bolt-On	10K AIC Bolt-On	22K AIC Bolt-On	Wire Range	
					CU	AL
100	UQFB-100	UQFBH-100	UQFB-100-X1	UQFBH-M-100	#3-#1	#1-1/0
125	UQFB-125	UQFBH-125	UQFB-125-X1	UQFBH-M-125	#3-#1	#1-1/0
150	UQFB-150	UQFBH-150	UQFB-150-X1	UQFBH-M-150	1/0-300	2/0-300
175	UQFB-175	UQFBH-175	UQFB-175-X1	UQFBH-M-175	1/0-300	2/0-300
200	UQFB-200	UQFBH-200	UQFB-200-X1	UQFBH-M-200	1/0-300	2/0-300

## Notes

- **UL listed:** For use with 60°C or 75°C wire.
- **UQFP:** For parallel main circuit breaker applications.
- **UQFP-M:** For series main circuit breaker applications. Split load tab features allow for feed-through capability.
- **UQFB3:** Three-pole available. Consult factory.
- **UQFB-M:** For series main circuit breaker applications. Split load tab features allow for feed-through capability.

Please consult serving utility for their requirements prior to ordering or installing, as specifications and approvals vary by utility, and may require local electrical inspector approval. All installations must be installed by a licensed electrician and must comply with all national and local codes, laws and regulations. Milbank reserves the right to make changes in specifications and features shown without notice or obligation.



**15–125 Amp Breaker  
Plug-In Type | 1" Per Pole**

Amp	Poles	10K AIC Plug-In	22K AIC Plug-In
15	Single	Q115	Q115H
15	Double	Q215	Q215H
20	Single	Q120	Q120H
20	Double	Q220	Q220H
25	Single	Q125	Q125H
25	Double	Q225	Q225H
30	Single	Q130	Q130H
30	Double	Q230	Q230H
35	Single	Q135	Q135H
35	Double	Q235	Q235H
40	Single	Q140	Q140H
40	Double	Q240	Q240H
50	Single	Q150	Q150H
50	Double	Q250	Q250H
60	Single	Q160	Q160H
60	Double	Q260	Q260H
70	Single	Q170	Q170H
70	Double	Q270	Q270H
80	Double	Q280	Q280H
90	Double	Q290	Q290H
100	Double	Q2100	Q2100H
125	Double	Q2125	Q2125H



QN2200H



QN2200RH



WBJ2200



Q250

**200 Amp Frame | Plug-In | 10,000 AIC & 22,000 AIC | Two-Pole, Common Trip**

Amp	10K AIC Plug-In	22K AIC Plug-In	Handle Location	Wire Range	
				CU	AL
150	QN2150	QN2150H	Left facing	#4-300	#4-300
200	QN2200	QN2200H	Left facing	#4-300	#4-300
150	QN2150R	QN2150RH	Right facing	#4-300	#4-300
200	QN2200R	QN2200RH	Right facing	#4-300	#4-300
150	WBJ2150	—	Centered	#2-300	#2-300
200	WBJ2200	—	Centered	#2-300	#2-300

**Notes**

- Load connectors supplied with breakers.
- UL listed for use with 60°C or 75°C wire.
- Wire sizes shown are lug capacity. Consult NEC Article #310 for specific wire sizes.



Please consult serving utility for their requirements prior to ordering or installing, as specifications and approvals vary by utility, and may require local electrical inspector approval. All installations must be installed by a licensed electrician and must comply with all national and local codes, laws and regulations. Milbank reserves the right to make changes in specifications and features shown without notice or obligation.

# Accessories

## Hubs and Closing Plates

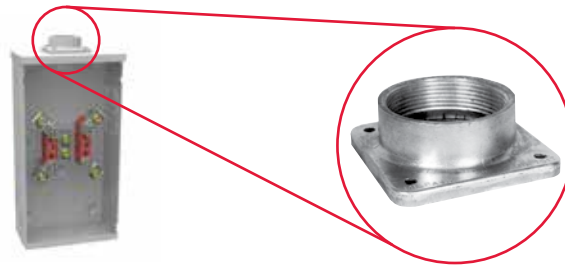
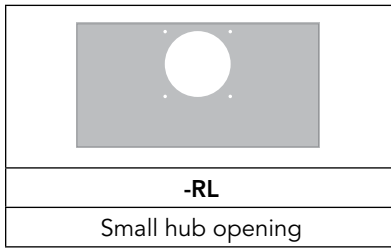

<b>-WL</b>   <b>A7514</b>	<b>-YL</b>   <b>A7515</b>	<b>-ZL</b>   <b>A7516</b>	<b>-DL</b>   <b>A7517</b>	<b>-EL</b>   <b>A7518</b>	<b>-XL</b>   <b>A7551</b>
1" hub	1¼" hub	1½" hub	2" hub	2½" hub	Small closing plate

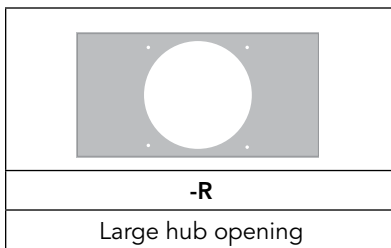

<b>-F</b>   <b>A8110</b>	<b>-G</b>   <b>A8111</b>	<b>-H</b>   <b>A8112</b>	<b>-X</b>   <b>A9064</b>	<b>-RRL</b>   <b>S8324</b>
3" hub	3½" hub	4" hub	Large closing plate	Large hub opening adapted to small hub opening

### Notes



- **Suffix:** Add to catalog number for factory installation of hub.
- **Packaging:** Individually packed units for field installation.
- **Abbreviations:** H.O. (hub opening), C.P. (closing plate).
- Hub Mast rated.

Please consult serving utility for their requirements prior to ordering or installing, as specifications and approvals vary by utility, and may require local electrical inspector approval. All installations must be installed by a licensed electrician and must comply with all national and local codes, laws and regulations. Milbank reserves the right to make changes in specifications and features shown without notice or obligation.



## Connector Kits, Closing Kits & Generator Interlock

### Connector Kits — For Use with 3/8"-16 Stud Type Units Only

					
Single			Twin		
Suffix	Part #	(3 per set) - 1Ø	Suffix	Part #	(3 per set) - 1Ø
K1	<b>K1539</b>	6-350	K2	<b>K1350</b>	6-350
K3	<b>K1540</b>	4-600 or (2) 1/0-250*	K2L	<b>K1350L</b>	6-350 (non rotating)
K3L	<b>K1540L</b>	4-600 or (2) 1/0-250* (non rotating)	K4	<b>K1541</b>	4-600
Suffix	Part #	(4 per set) - 3Ø	Suffix	Part #	(4 per set) - 3Ø
K5	<b>K3082</b>	6-350	K6	<b>K3442</b>	6-350
K7	<b>K3441</b>	4-600 or (2) 1/0-250*	K8	<b>K3083</b>	4-600

\*For (2) 1/0-250, conductors must be of same size.



### Bypass Link



### Note

Consult factory for proper connector kits for studded meter sockets.



### Closing Covers

	
Meter Closing Plate (Ring Type/Ringless)	Metal Closing Plate (For Ringless Sockets)
<b>6003</b> - Grey Plastic	<b>CP-21</b>
<b>6116</b> - Clear Plastic	
<b>6002</b> - Clear Plastic w/ blades	

### Note

Consult factory for kits that are available.

### Sealing Rings

	
<b>MR-2</b> - Snap Action	<b>MR-4</b> - Screw Type (Stainless Steel)
<b>MR2-SS</b> - Stainless Steel	

### Touch-Up Paint





Please consult serving utility for their requirements prior to ordering or installing, as specifications and approvals vary by utility, and may require local electrical inspector approval. All installations must be installed by a licensed electrician and must comply with all national and local codes, laws and regulations. Milbank reserves the right to make changes in specifications and features shown without notice or obligation.

# Accessories

## Fifth Terminal, Tap Connectors & Block Assemblies

### Fifth Terminal

		
<b>5T8K2</b> - 100-200 amp "Plug-In"	<b>K5T</b> - 200 amp (Block with Square Hole)	<b>K3865</b> - Heavy Duty Jaw Clamping ( <b>K3866</b> without Neutral Wire)

### Tap Connectors (3 per set)

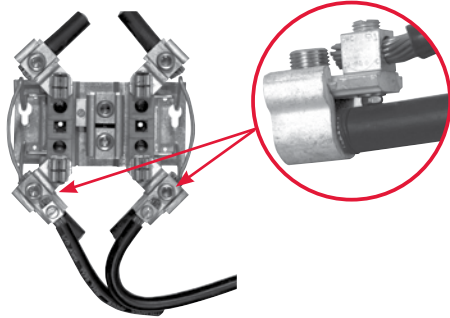
	Replaces the load or line side slide-in nut assembly on Milbank 200 amp sockets. Allows for a 100 amp tap location in addition to the #6-350 kcmil load-side connector. <b>K5022</b> includes safety barrier extensions for applications over 300 VAC. Three lugs per kit.
<b>K4977-INT</b> - Internal Hex	
<b>K4977-EXT</b> - External Hex	
<b>K5022-INT</b> - Internal Hex (set of 4 w/ barrier)	

### Triplex Ground

<b>K1190</b> (For factory installed triplex ground, add suffix -TG to catalog number)

### Disconnect Sleeve

<b>M5-144</b>
<b>Do not use with lever bypass sockets</b>

### 100 Amp Blocks *(single sockets only)*

<b>BL7499</b> - Block Assembly (w/ horn bypass)

### 200 Amp Blocks *(single sockets only)*

<b>K4529</b> - Internal Hex Block Assembly (w/ horn bypass)

### Anti-Inversion Clip

<b>K4802</b>

### Isolated Neutral Kit

<b>K1047*</b>

\*Isolated neutrals are specific to the meter socket. Consult factory for correct isolated neutral.

Please consult serving utility for their requirements prior to ordering or installing, as specifications and approvals vary by utility, and may require local electrical inspector approval. All installations must be installed by a licensed electrician and must comply with all national and local codes, laws and regulations. Milbank reserves the right to make changes in specifications and features shown without notice or obligation.



Catalog Number	DPL	DUQES	FE, West PENN, Allegheny	PPL	PECO	ACE	PSEG	AEP
<b>125A 4-T OU</b>								
U7274-YL-KK		X						
U7487-RL-TG-KK-BLG			X	X				X
U7487-YL-TG-KK-BLG			X	X				
U7487-RL-KK-BL					X			
<b>125A 5-T OU</b>								
U8569-YL-KK-BLG							X	
<b>200A 4-T OH</b>								
U7021-RL-KK-BL					X			
U7021-RL-KK-DLC		X						
U7021-RL-TG-KK-BLG			X	X				
<b>200A 4-T OU</b>								
U7040-RL-TG-KK-BLG								X
U7040-RL-KK-DPL	X					X		
<b>200A 4-T UG</b>								
U1980-O-KK-BL					X			
U1980-O-KK-DPL	X					X		
U1980-O-KK-BLG								X
U3126-O-KK-BLG			X	X				
U3126-O-KK-DLC		X						
U4413-O-KK-BL					X			
U4413-O-KK-BLG			X	X				
U4413-O-KK-DPL	X					X		
<b>200A 5-T OH or OU</b>								
U8173-XL-KK-BLG(OU)							X	
U9551-X-DPL (OU)	X					X		
U9551-R-5T9			X					
<b>200A 7-T OH</b>								
U9700-RRL-BLG			X					
U9701-RRL-BLG			X					X
<b>200A 7-T OU</b>								
U7423-RXL					X			
U4029-X-DPL	X					X		
U4701-XL-BLG-PSEG							X	
U9701-RRL-BLG			X	X				X
<b>200A 7-T UG</b>								
U3786-O-BLG			X	X				
<b>320A 4-T UG</b>								
U1079-RRL-K3-BLG				X				
S6142-X-INV-DPL	X					X		
U3939-X				X				
U1797-O-K3L-K2L-BLG								X
U3000-O-2/K3L-BL					X			

Catalog Number	DPL	DUQES	FE, West PENN, Allegheny	PPL	PECO	ACE	PSEG	AEP
<b>320A 4-T OU</b>								
U1779-R-K3-BLG			X					
U4912-X-K3-BLG			X					
<b>320A 7-T OU</b>								
U4168-X-K7-BLG			X	X				
<b>100A GANG SOCKETS</b>								
U8032-XL-KK-BLG			X					
U8032-XL-KK-BL					X			
U8033-XL-KK-BLG			X					
U8033-XL-KK-BL					X			
U8034-XL-KK-BLG			X					
U8034-XL-KK-BL					X			
U8035-XL-KK-BLG			X					
U8035-XL-KK-BL					X			
U8036-XL-KK-BLG			X					
U8036-XL-KK-BL					X			
U1282-XL-KK-BLG								X
U1283-XL-KK-BLG								X
U8212-XL-KK-BLG			X	X				
U8213-XL-KK-BLG			X	X				
U8214-XL-KK-BLG			X	X				
U8215-XL-KK-BLG			X					
U8216-XL-KK-BLG			X					
U2692-XL-KK-BL					X			
U2693-XL-KK-BL					X			
<b>150A GANG SOCKETS</b>								
U9312-XL-KK-DLC		X						
U9313-XL-KK-DLC		X						
U9314-XL-KK-DLC		X						



Please consult serving utility for their requirements prior to ordering or installing, as specifications and approvals vary by utility, and may require local electrical inspector approval. All installations must be installed by a licensed electrician and must comply with all national and local codes, laws and regulations. Milbank reserves the right to make changes in specifications and features shown without notice or obligation.

# Utility Approval List

Catalog Number	DPL	DUQ	FE, West PENN, Allegheny	PPL	PECO	ACE	PSEG	AEP
<b>200A GANG SOCKETS</b>								
U1252-X-KK-K3-BLG			X	X				
U1252-X-KK-K3-BL					X			
U1252-X-KK-K3-DPL	X					X		
U1252-RRL-KK-K1-BLG-SLVG								X
U1252-X-KK-K3-DLC		X						
U1253-X-KK-K3-BLG			X	X				
U1253-X-KK-K3-BL					X			
U1253-RRL-KK-K1-BLG-SLVG								X
U1253-X-KK-K3-DLC		X						
U1254-X-KK-K3-BLG			X	X				
U1254-X-KK-K3-BL					X			
U1254-X-KK-K3-DPL	X					X		
U1254-RXL-KK-K1-BLG-SLVG								X
U1254-X-KK-K3-DLC		X						
U1255-X-KK-K3-BLG			X	X				
U1255-X-KK-K3-BL					X			
U1255-RXL-KK-K1-BLG-SLVG								X
U1255 X-KK-K3-DLC		X						
U1256-X-KK-K3-BLG			X	X				
U1256-X-KK-K3-BL					X			
U1256-X-KK-K4-DPL	X					X		
U1256-RXL-KK-K1-BLG-SLVG								X
U1256-X-KK-K3-DLC		X						
U5898-O-100-KK-BLG			X	X				X
<b>100A METER MAIN OH</b>								
U7375-RL-KK			X					
<b>200A METER MAIN OU</b>								
U5168-XTL-100-KK-BL					X			
U5168-XTL-100-KK-BLG			X	X				X
U5168-XTL-200-KK-BL					X			
U5168-XTL-200-KK-BLG			X	X				X
U5898-O-200-KK-BL					X			
U5898-O-200-KK-BLG			X	X				X
U5268-XTL-200-KK-BLG			X	X				X

Catalog Number	DPL	DUQ	FE, West PENN, Allegheny	PPL	PECO	ACE	PSEG	AEP
<b>200A METER MAIN OH</b>								
USE-22-200-MB								
U5902-X-KK-BL					X			
U5902-X-KK-BLG				X				X
U5903-X-KK-BL					X			
U5903-X-KK-BLG				X				X
U5904-X-KK-BL					X			
U5904-X-KK-BLG				X				X
U5905-X-KK-BL					X			
U5905-X-KK-BLG				X				X
U5906-X-KK-BL					X			
U5906-X-KK-BLG				X				X
U5882-X-KK-BL					X			
U5882-X-KK-BLG				X				X
U5883-X-KK-BL					X			
U5883-X-KK-BLG				X				X
U5884-X-KK-BL					X			
U5884-X-KK-BLG				X				X
U5885-X-KK-BL					X			
U5885-X-KK-BLG				X				X
U5886-X-KK-BL					X			
U5886-X-KK-BLG				X				X
<b>200A METERED PEDESTAL</b>								
U5136-O								
U5136-O-100S			X	X				
U5136-O-200S			X	X				
U5137-O								
U5137-O-100S			X	X				
U5137-O-200S			X	X				
<b>CT ENCLOSURES</b>								
U5990-O			X					
CE136-CECHA					X			
484812-CT3R-SP				X				

Please consult serving utility for their requirements prior to ordering or installing, as specifications and approvals vary by utility, and may require local electrical inspector approval. All installations must be installed by a licensed electrician and must comply with all national and local codes, laws and regulations. Milbank reserves the right to make changes in specifications and features shown without notice or obligation.



*Attractive | Easy to Install | Secure | Cost-Effective*

**Milbank Commercial Pedestals** are pad-mounted, weather resistant electrical enclosures consisting of a utility pull section with optional meter socket, and a customer section containing distribution and control equipment. Milbank Commercial Pedestals are an attractive, secure, easy to install and cost-effective solution when underground remote site power distribution and control equipment is required, replacing unsightly and inefficient strut and backboard structures.



Strut and backboard



Commercial pedestal

## UL listed as Industrial Control Equipment (File E113855)

### Standard Features

- Type 3R rain-resistant, vandal-resistant cabinet of polyurethane powder-coated steel (aluminum or stainless steel also available)
- UL listed as enclosed industrial control equipment (UL508)
- Isolated lockable & sealable utility metering and lug landing sections
- Lockable customer section for distribution and control equipment with internal deadfront
- Print pocket inside customer section door contains wiring schematics and installation instructions
- Most load centers are UL listed for use with various manufacturers' circuit breakers
- All stainless steel external hardware (screws, bolts, hinges, handles, hasps and sealing screws)

**Note**  
All meter form and bypass options available to meet utility requirements.

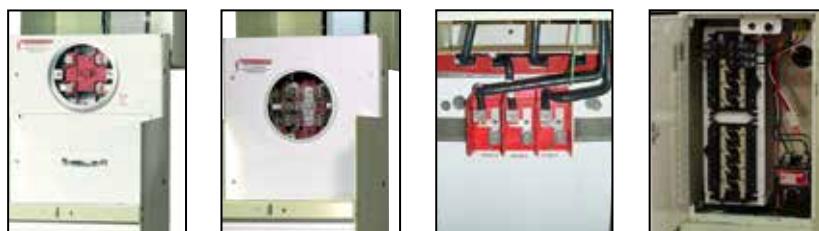

Please consult serving utility for their requirements prior to ordering or installing, as specifications and approvals vary by utility, and may require local electrical inspector approval. All installations must be installed by a licensed electrician and must comply with all national and local codes, laws and regulations. Milbank reserves the right to make changes in specifications and features shown without notice or obligation.



# Commercial Pedestals

Attractive | Easy to Install | Secure | Cost-Effective

**41**  
COMMERCIAL  
PEDESTALS



## Applications

These units are ideal for controlling and metering:

- Traffic signals
- Street lighting
- Power distribution for EV charging stations
- Irrigation and sprinkler systems
- Cell towers and telephone vaults
- Pump stations
- Temporary power for fairgrounds, swap meets, outdoor markets, portable offices, holiday lights, etc.
- Outdoor lighting for athletic fields, tennis and basketball courts, parking lots, landscaping and subdivision entrances, etc.

## Available Factory-Installed Options

- Meter sockets: ring type or ringless, up to 400 amp
- Main and branch breakers or T fuses
- Distribution: copper load centers and panel boards
- Clocks, timers and relays
- Photoelectric cells and controls
- Power receptacles: pin and sleeve, twist lock or straight blade
- Contactors: definite purpose, electrical or mechanically held, IEC and mercury types
- Surge protection and lightning arrestors
- Reserve inlet generator receptacle with interlocked circuit breakers
- Motor starters and relays
- Push button controls
- Thermostat controls, fans and heating strips
- Power blocks and terminal blocks
- Steel, aluminum and plywood backboards
- Transformers
- Interlock devices for circuit breakers
- Available in steel, aluminum (raw painted or anodized) or stainless steel construction with powder-coated finish available in eight standard colors or special-ordered RAL colors
- Available for applications up to 400 amp, 120V, 208V, 240V, 277V, 480V - 1Ø or 3Ø

Please consult serving utility for their requirements prior to ordering or installing, as specifications and approvals vary by utility, and may require local electrical inspector approval. All installations must be installed by a licensed electrician and must comply with all national and local codes, laws and regulations. Milbank reserves the right to make changes in specifications and features shown without notice or obligation.

## Accessories



**K3865**  
Fifth terminal kit for use with ringless meter sockets

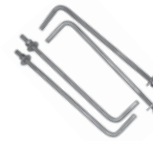

**CP-ABK5/8**  
Anchor bolt kit (includes four 5/8 - 13 x 18" anchor bolts)



**105J**  
Fifth terminal kit for use with ring-type meter sockets



**CP-TC7D**  
7-day time clock kit  
**CP-TC24H**  
24-hour time clock kit  
**CP-TCWIRE**  
Male 4-pin connector and wiring harness for use with time clocks other than above

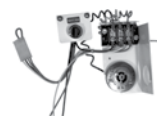

**CP-PE-HOA-3POS**  
HOA switch for field installation



**CP-16PDMNT-CALT**  
16" pedestal mounting base  
**CP-24PDMNT-CALT**  
24" pedestal mounting base (includes mounting hardware)



### CP3B "ML" Series

Main Load Center Series

1Ø3 wire 120/240V or 208Y/120V

Application: remote site service for multiple loads

**Milbank Main Load Center Commercial Pedestals** are designed to handle the vast majority of all requirements in a standard, stocked configuration.

- All units feature a load center with a plug-on, back-fed main breaker.
- Load center has 16 positions for the 100 amp pedestals and 24 circuits for the 200 amp pedestals.
- Both sizes include sub-feed lugs to allow feeding an external panel.

If your application requires turning loads on based on "dusk-to-dawn" requirements, be sure to see the Milbank Switched Load Center Commercial Pedestal products on the following page.

#### Features

These units include everything required for remote site service:

- NEMA 3R construction.
- Expandable: load centers allow for future expansion without costly modifications.
- All units feature 200 amp meter socket with optional field installable fifth terminal kit available.
- 22K ampere interrupting capacity (AIC) standard.
- Optional mounting base can be embedded in concrete for fast, easy installation.
- Separate sealable and lockable utility termination section.
- Separate sealable and lockable metering section.
- Separate sealable and lockable customer section with a load center for "always on" loads that include a main circuit breaker, 20 (125 or 200 amp model) or 14 (100 amp model) blank breaker spaces and a circuit directory to document configuration.

**Note**  
All meter form and bypass options available to meet utility requirements.



**Typical Applications**  
Remote site service for multiple loads.

Stocked Pedestals	Optional Fifth Terminal Kit	Main CB		Load Center Circuits	Meter Socket Type
		Amp	Spaces		
CP3B51115A22	K3865	100	1,2	16	Ringless socket with lever bypass
CP3B52119A22	K3865	200	1,2,3,4	24	Ringless socket with lever bypass

#### Notes

- Chart shows standard, stocked items. Other options and features are available. Contact factory for options, details and availability.



Please consult serving utility for their requirements prior to ordering or installing, as specifications and approvals vary by utility, and may require local electrical inspector approval. All installations must be installed by a licensed electrician and must comply with all national and local codes, laws and regulations. Milbank reserves the right to make changes in specifications and features shown without notice or obligation.

# Commercial Pedestals

Switched Load Center Series | Custom Designs Available

## CP3B "SL" Series

Switched Load Center Series

1Ø3 wire 120/240V or 208Y/120V

**Note**  
All meter form and bypass options available to meet utility requirements.

**Milbank Switched Load Center Commercial Pedestals** are designed not only to provide power for various loads, but also to switch specific loads on and off under certain conditions. A photoelectric cell is used for these controlled loads, and an optional time clock is also available.

### Features

These units include everything required for remote site service:

- NEMA 3R construction.
- Expandable: load centers allow for future expansion without costly modifications.
- All units feature 200 amp meter socket with optional field installable fifth terminal kit available.
- 22K amp interrupting capacity (AIC) standard.
- Optional mounting base can be embedded in concrete for fast, easy installation.
- Separate sealable and lockable utility termination section.
- Separate sealable and lockable metering section.
- Separate sealable and lockable customer section with a control circuit including PE receptacle, Lexan® window, glare shield, Hand-Off-Auto (HOA) switch, contractor controlling a 16-circuit load center for controlled loads, a pre-mounted DIN rail and pre-wired connector to add an optional "plug-and-play" time clock kit for PE on and TC off operation and a circuit directory to document configuration.
- A load center for "always on" loads that includes a main circuit breaker, a control power circuit breaker, a switched load center main breaker, nine (125 or 200 amp model) or 11 (100 amp model) blank breaker spaces and a circuit directory to document configuration.



**Typical Applications**  
Traffic signals, parking lots, highways & athletic field lighting

Stocked Pedestals	Optional Fifth Terminal Kit	Main CB		Contactor Amperage	Meter Socket Type
		Amp	Spaces		
CP3B51110A22SL1	K3865	100	1,3	60	Ringless socket with lever bypass
CP3B52110A22SL1	K3865	200	1,2,3,4	100	Ringless socket with lever bypass

### Notes

- Chart shows standard, stocked items. Other options and features are available. Contact factory for options, details and availability.

Please consult serving utility for their requirements prior to ordering or installing, as specifications and approvals vary by utility, and may require local electrical inspector approval. All installations must be installed by a licensed electrician and must comply with all national and local codes, laws and regulations. Milbank reserves the right to make changes in specifications and features shown without notice or obligation.



# Commercial Pedestals

## CP3B "400" 400 Amp Series



**Milbank 400 Amp Commercial Pedestals** are designed to provide a weather and vandal resistant metered enclosure for various loads and distribution. Each pedestal has been designed to handle a wide range of applications using standard, stocked configurations.

- Choice of a single main breaker or twin service disconnect breakers gives flexibility to the pedestal design.
- Optional distribution with feed-through lugs below the service disconnect breakers allows the pedestal to handle numerous applications.
- Typical applications include remote homes where the metering is best located at the curb side or other remote area. The pedestal can also provide power to secondary residence, on-site business, workshop, irrigation, lighting, security or other secondary load.
- Available in custom colors to match home or landscaping.

### Features

These units include everything required for remote service:

- Type 3R construction
- Main circuit breaker or dual service disconnects
- Expandable: load center units allow for future expansion without costly modifications
- Optional mounting base can be embedded in concrete for fast, easy installation
- Separate sealable and lockable utility termination section with lug termination
- Separate sealable and lockable metering section
- A separate sealable and lockable customer section with a circuit directory and a print pocket to hold all documentation
- Meter socket options include ring type with bypass studs, ringless with heavy duty lever bypass, or K-Type bolt-on

#### Typical Applications

Remote site service for residential and commercial job sites.

Standard Pedestals	Optional fifth Terminal Kit	Main CB	Load Center Circuits	Meter Socket Type
CP3B54120B22	K3865	2-200 amp	(2) 12 circuit	Ringless with lever bypass
CP3B5411JB22	K3865	320 amp (400 max)	0	Ringless with lever bypass

### Notes

- Chart shows standard, stocked items. Other options and features are available. Contact factory for options, details and availability.
- Stud utility landing is standard. Lug kits are available from factory.
- Units with load centers have (2) #6-250 sub-feed lugs on each load center. (Each load center is 200 amp rated and UL listed with: Siemens, General Electric and Cutler-Hammer plug-in style circuit breakers.)



Please consult serving utility for their requirements prior to ordering or installing, as specifications and approvals vary by utility, and may require local electrical inspector approval. All installations must be installed by a licensed electrician and must comply with all national and local codes, laws and regulations. Milbank reserves the right to make changes in specifications and features shown without notice or obligation.

# Commercial Pedestals

## CP3B "IR" Irrigation Control Series



**Milbank "IR" Series Irrigation Pedestals** install quickly and simply – often in less than an hour with a single technician – a fraction of the time typically needed for strut farm and other installation set ups. Additionally, the pedestal comes pre-wired, so the technician simply drops in the pre-drilled concrete box pad, fastens the pedestal and runs the wires. Prewired landing lugs are provided in a separate utility side so that there is no more need to wrestle with hard-to-bend wires. Simply run the utility wire up and land on the lugs. With both the motor starter and disconnect in the same enclosure, all the controls are housed in a safe, lockable pedestal that protects against vandalism and energy theft.

### Features

- 3Ø4W, 480Y/277 volt
- One technician can install in under an hour with use of Milbank's pre-drilled box pad
- All units are UL listed and service entrance rated
- Fused disconnect with accessible handle through the deadfront
- HOA and push button start
- Separate accessible utility side with pre-wired landing lugs
- NEMA rated starters (sizes 1-5)
- Soft start units sizes 30HP-150HP
- 30 amp fuse block for pivot pre-wired in the unit
- White powder coated paint finish helps keep components cooler
  - Options include:
    - Hour meter
    - Chemical injection receptacle
    - Multiple injection receptacle
    - Multiple 30 amp fuse blocks possible

### Typical Applications

Power pedestal for irrigation systems or other pump control applications.

Stocked Pedestals	Exterior Cabinet	NEMA Rating
CP3B0281UMWIR04	White	4
CP3B0281UMWIR03	White	3
CP3B0181UMWIR02	White	2

### Notes

- Chart shows standard, stocked items. Other options and features are available. Contact factory for options, details and availability.

Please consult serving utility for their requirements prior to ordering or installing, as specifications and approvals vary by utility, and may require local electrical inspector approval. All installations must be installed by a licensed electrician and must comply with all national and local codes, laws and regulations. Milbank reserves the right to make changes in specifications and features shown without notice or obligation.



# Commercial Pedestals

## CP3B "BBS" Battery Backup Series



**Milbank BBS Series Commercial Pedestals** are designed to provide battery backup power for various loads, and to switch specific loads on and off under certain conditions; a photoelectric cell or time clock to control lighting circuits, as an example. Metered and unmetered power distribution options are available. The back-up power pedestal is designed to handle the vast majority of today's back-up power requirements. By using 19" rack design, shelves can be adjusted to accommodate the required batteries and manufactures DC to AC inverters, transfer switches and other related equipment. This design gives the user a wide range of design and configuration options. Complete turnkey, ready to power-up pedestals are offered along with basic units ready to accept batteries and inverters supplied by others.

### Features

- Type 3R construction
- 100 through 320 amp meter socket with the option of either a ring type socket (conforms to EUSERC 308) with or without test/bypass blocks or a heavy duty ringless socket with lever bypass
- Separate sealable utility termination compartment
- An isolated separate customer section with service disconnects, power distribution options and power control
- 19" wide rack in customer compartment for easy layout of equipment
- Battery trays
- Thermostat with cooling fan
- Filtered louvers for heat rise flow through ventilation
- Three point door latch (key or pad lockable)

### Typical Applications

Metered emergency uninterrupted power for traffic intersections, wireless, phone and communications equipment, parking lots, camera and security locations.

### Options

- Manual bypass switch
- Transfer switch for generator power back-up
- Generator inlet receptacles 30 amp through 200 amp
- Pad lockable provision for receptacles
- Police access door
- Metered load center distribution
- Unmetered load center distribution
- Photo electric controls (for street lighting)
- Time clocks
- HOA switches
- Contactors
- GFI duplex receptacles
- Thermostat for heating control
- Heating pads or elements
- Roll out shelves for batteries
- Surge arrestors and lighting arrestors



Please consult serving utility for their requirements prior to ordering or installing, as specifications and approvals vary by utility, and may require local electrical inspector approval. All installations must be installed by a licensed electrician and must comply with all national and local codes, laws and regulations. Milbank reserves the right to make changes in specifications and features shown without notice or obligation.

# Commercial Pedestals

## CP3B "Power Transfer" Series



**Milbank Power Transfer Series Pedestals** provide non metered AC power, distribution, surge suppression, mechanical interlock and stand-by generator receptacle all in a neat, compact pedestal.

### Features

- 120/240V 1Ø3W through 277/480V 3Ø4W ratings
- Metered or unmetered units
- Choice of EUSERC ring type or ringless meter sockets
- 60 amp through 400 amp ratings
- UL listed Type 3R rated
- Pad lockable, isolated utility compartments
- 20 amp GFI convenience receptacle
- Lockable recessed generator receptacle door
- Utility and generator indicator light options
- All stainless steel hardware
- Galvanized steel, aluminum or stainless steel cabinet options
- Custom designs available



### Typical Applications

Traffic intersections, cell sites, cable TV, pump and lift stations requiring utility power with backup generator power

Please consult serving utility for their requirements prior to ordering or installing, as specifications and approvals vary by utility, and may require local electrical inspector approval. All installations must be installed by a licensed electrician and must comply with all national and local codes, laws and regulations. Milbank reserves the right to make changes in specifications and features shown without notice or obligation.

# Commercial Pedestals

## CP3BB "CT Metered" Series



**Milbank CT Metered Series Commercial Pedestals** are designed to be used where a smaller service package would be a better choice over large 3R rated combination switchboards. These pedestals have amperage ratings of 400 to 800 amp at voltages up through 480 volt three phase.

### Features

- UL listed, freestanding Type 3R service
- A low profile CT pedestal
- All utility equipment is isolated in separated pad lockable and sealable compartments
- Separate customer compartment designed to hold distribution and control equipment
- Dead front customer construction
- Optional mounting base
- Optional construction in steel, aluminum and stainless steel.
- Wide choice of powder paint colors

### Typical Applications

Large homes, pumping and lift stations, motor control, water treatment plants, EV charging stations, commercial buildings, large remote service requirements, commercial and industrial control systems.



Please consult serving utility for their requirements prior to ordering or installing, as specifications and approvals vary by utility, and may require local electrical inspector approval. All installations must be installed by a licensed electrician and must comply with all national and local codes, laws and regulations. Milbank reserves the right to make changes in specifications and features shown without notice or obligation.



# Commercial Pedestals

## CP3A "Slimline" Series



**Milbank Slimline Series Commercial Pedestals** provide a sleeker, smaller footprint and wireway access on the side of the unit rather than the back, allowing maximum flexibility to place the pedestal in tighter spaces.

### Features

- UL listed as service equipment
- 100 or 200 amp
- Vandal-resistant, secure and attractive design
- Customer compartment with distribution and control equipment with swing dead front door, secured with both a hasp/latch and draw latch outer door
- Utility metering compartment protected with a hinged hood, increasing resistance to meter vandalism
- Small footprint
- Wireway located on left side of pedestal for utility incoming wire, allowing pedestal to be mounted with back very close to a wall (14")
- Available in 12" and 20" widths and 50" and 63" (metered) and 43" (unmetered) heights
- Includes a print pocket for plans and drawings
- 200 amp main available
- Voltage range: 120V–480V
- Compatible with both ringless and ring type meter sockets, 4–7 terminals
- Available in a wide array of colors, including but not limited too all ANSI powder coated paint colors upon request
- Pedestal mounting base option saves time and labor to install on a cement pad—no anchor bolts required
- Powder-coated G90 galvanized steel, raw, anodized or powder-coated aluminum and stainless steel exterior options

### "Slimline" Series Direct Bury Extension

- No need for concrete
- Bolts directly to unit
- Easy, modular design
- Ships in a smaller package
- Increases project flexibility
- Easier to handle and install
- Utilizes stabilizer feet to prevent leaning over time
- Pedestal and extension can be installed within 45 minutes

### Typical Applications

Roadway lighting and signage, wastewater treatment facilities, parks and landscaping, and any application where physical space is at a premium



### Notes

- 14 guage steel
- Only available for 12" pedestals

Please consult serving utility for their requirements prior to ordering or installing, as specifications and approvals vary by utility, and may require local electrical inspector approval. All installations must be installed by a licensed electrician and must comply with all national and local codes, laws and regulations. Milbank reserves the right to make changes in specifications and features shown without notice or obligation.



## NEMA Commercial Enclosures

---

Milbank's line of commercial enclosures includes the full gamut of styles and sizes; everything from junction boxes to transformer cabinets, telephone cabinets to wireway.

### Type 1 Enclosures

Milbank's Type 1 enclosures are designed for indoor use to provide a degree of protection to personnel against access to hazardous parts and to provide a degree of protection of the equipment inside the enclosure against ingress of solid foreign objects, such as falling dirt.

### Type 3R Enclosures

Milbank's Type 3R enclosures are designed for either indoor or outdoor use to provide a degree of protection from harmful effects on the equipment due to the ingress of water (rain, sleet, snow) and that will be undamaged by the external formation of ice on the enclosure.

### Wireway

Milbank's wide range of wireway is available in many styles and sizes and its wide range of fittings allows it to smoothly transition to and from competitors' products.



## NEMA Industrial Enclosures

---

Milbank's line of industrial enclosures include junction boxes, wiring trough, push-button enclosures and modular enclosures. Milbank also excels in special designs; nearly any type, size or color of enclosure you need, we can make!

### Type 12 Enclosures

Enclosures constructed without knockouts for indoor use to provide a degree of protection to personnel against access to hazardous parts, and protect components against falling dirt, circulating dust and lint, and dripping or splashing water.

### Type 4 Enclosures

Enclosures constructed for either indoor or outdoor use to provide a degree of protection to personnel against access to hazardous parts; protect equipment against falling dirt and windblown dust; protect against rain, sleet, snow, splashing water, and hose directed water; and is resistant to damage by the external formation of ice on the enclosure.

### Industrial Enclosure Specials

Milbank specializes in custom enclosure projects, offering an almost limitless amount of styles, options, colors and sizes. Milbank will meet your needs and specifications and deliver a custom enclosure that protects your crucial electric equipment.

### Thermal Management

Protect components housed in enclosures from damage caused by overheating, freezing, humidity and condensation with these thermal management products.



Please consult serving utility for their requirements prior to ordering or installing, as specifications and approvals vary by utility, and may require local electrical inspector approval. All installations must be installed by a licensed electrician and must comply with all national and local codes, laws and regulations. Milbank reserves the right to make changes in specifications and features shown without notice or obligation.

# Watt-hour Meter Forms

Standard Forms | Transformer Rated or Self-Contained

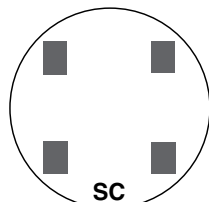

**SC**  
2 and 3-WIRE FORMS  
1S & 2S

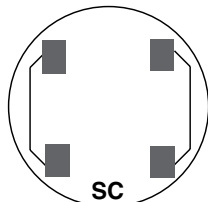

**SC**  
2 and 3-WIRE FORMS  
1S & 2S with BYPASS

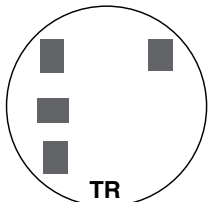

**TR**  
2-WIRE FORM 3S  
5th Term. 9 o'clock

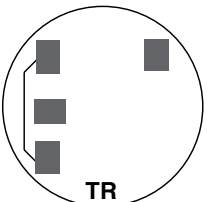

**TR**  
2-WIRE FORM 3S  
with BYPASS

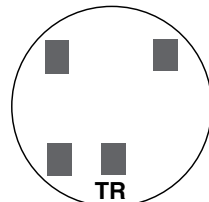

**TR**  
2-WIRE FORM 3S  
5th Term. 6 o'clock

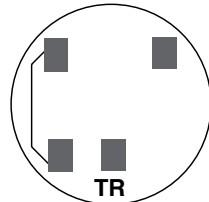

**TR**  
2-WIRE FORM 3S  
with BYPASS

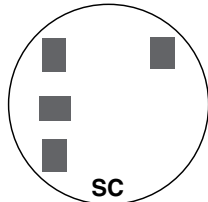

**SC**  
2 ELEMENT  
3-WIRE NETWORK  
FORM 12S 5th  
TERM. 9 o'clock

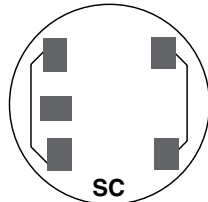

**SC**  
2 ELEMENT 3-WIRE  
NETWORK FORM 12S  
with BYPASS  
5th Term. 9 o'clock

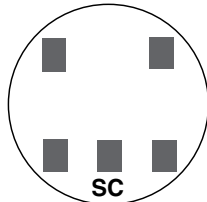

**SC**  
2 ELEMENT  
3-WIRE NETWORK  
FORM 12S 5th  
TERM. 6 o'clock

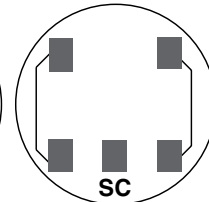

**SC**  
2 ELEMENT 3-WIRE  
NETWORK FORM 12S  
with BYPASS  
5th Term. 6 o'clock

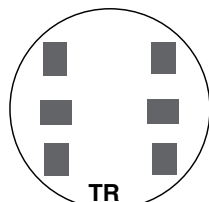

**TR**  
3-WIRE FORM 4S

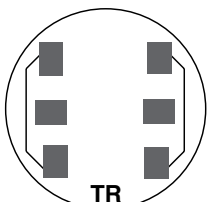

**TR**  
3-WIRE FORM 4S  
WITH BYPASS

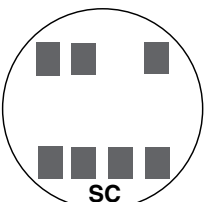

**SC**  
2 or 3 ELEMENT  
3Ø4W Y or  
Y FORM 14S  
FORM 15S  
Y FORM 16S

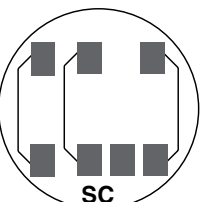

**SC**  
2 or 3 ELEMENT  
3Ø4W Y or  
FORMS 14S & 15S  
with BYPASS

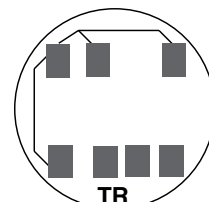

**TR**  
2 ELEMENT  
3Ø4W Y or  
Y FORM 7S  
FORM 24S  
with BYPASS

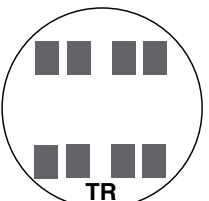

**TR**  
2 ELEMENT  
2Ø3W, 2Ø4W, 3Ø3W  
FORM 5S

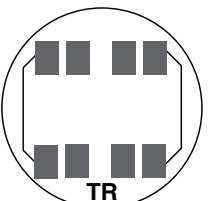

**TR**  
2 ELEMENT 3Ø3W,  
2Ø4W, 3Ø3W  
FORM 5S with  
BYPASS

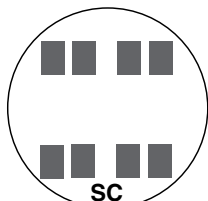

**SC**  
2 ELEMENT  
2Ø3W, 2Ø4W, 3Ø3W  
FORM 13S

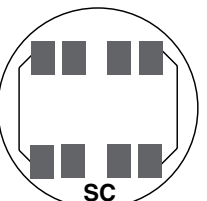

**SC**  
2 or 3 ELEMENT  
2Ø3W, 2Ø4W, 3Ø3W  
FORM 13S with  
BYPASS

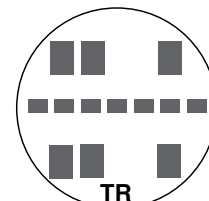

**TR**  
2 or 3 ELEMENT  
3Ø4W Y or  
Y FORM 9S  
FORM 8S

TR = TRANSFORMER RATED  
SC = SELF CONTAINED

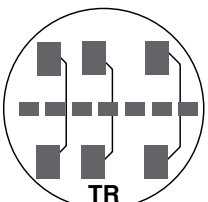

**TR**  
2 or 3 ELEMENT  
3Ø4W Y or  
FORMS 8S & 9S  
FORMS 8S & 9S  
with BYPASS

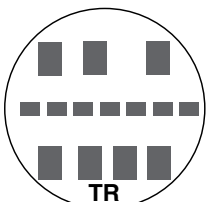

**TR**  
2 ELEMENT  
3Ø4W Y  
FORM 6S

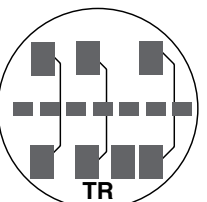

**TR**  
2 ELEMENT  
3Ø4W Y  
FORM 6S  
with BYPASS

Please consult serving utility for their requirements prior to ordering or installing, as specifications and approvals vary by utility, and may require local electrical inspector approval. All installations must be installed by a licensed electrician and must comply with all national and local codes, laws and regulations. Milbank reserves the right to make changes in specifications and features shown without notice or obligation.



**DIAGRAM A**  
1 $\emptyset$ 2W with 1 P.T. & 1 C.T.  
Single Stator Meter (2W1 $\emptyset$ ) - Form 3S  
5T Socket, Test Switch #TS04-0101

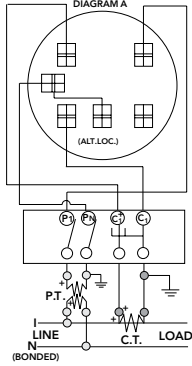

**DIAGRAM B**  
1 $\emptyset$ 3W with 1 C.T.  
Single Stator Meter (2W1 $\emptyset$ ) - Form 3S  
5T Socket, Test Switch #TS04-0101

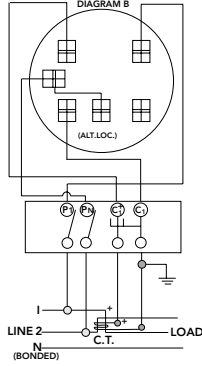

**DIAGRAM C**  
1 $\emptyset$ 3W with 2 C.T.'s  
Single Stator Meter (3W1 $\emptyset$ ) - Form 4S  
6T Socket, Test Switch #TS07-0105

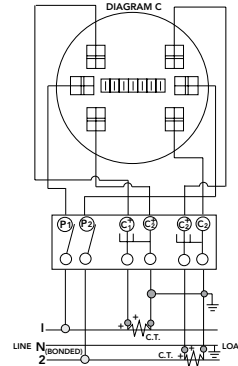

**DIAGRAM D**  
1 $\emptyset$ 3W or 3W Network with 2 C.T.'s  
2 Stator Meter - Form 5S  
8T Socket, Test Switch #TS07-0105

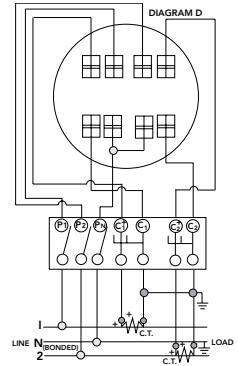

**DIAGRAM E**  
3 $\emptyset$ 3W "A" with 2 P.T.'s & 2 C.T.'s  
2 Stator Meter - Form 5S  
8T Socket, Test Switch #TS07-0105

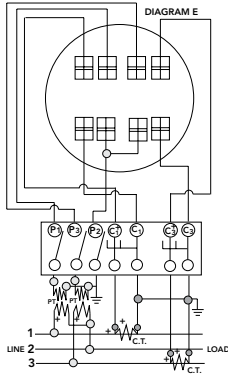

**DIAGRAM F**  
3 $\emptyset$ 3W "A" with 2 C.T.'s  
2 Stator Meter - Form 5S  
8T Socket, Test Switch #TS07-0105

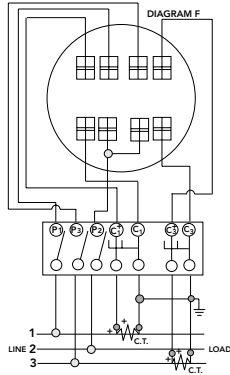

**DIAGRAM G**  
3 $\emptyset$ 4W "Y" with 3 C.T.'s  
2 1/2 Stator Meter - Form 6S  
13T Socket, Test Switch #TS10-0109

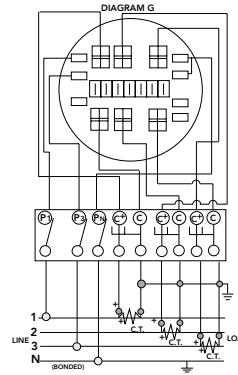

**DIAGRAM H**  
3 $\emptyset$ 4W "Y" with 2 P.T.'s & 3 C.T.'s  
2 1/2 Stator Meter - Form 6S  
13T Socket, Test Switch #TS10-0109

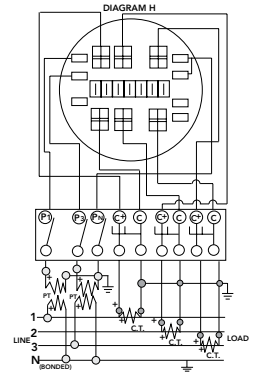

**DIAGRAM I**  
3 $\emptyset$ 4W "Y" or "A" with 3 C.T.'s  
"Y" 3 Stator Meter - Form 9S  
"A" 2 Stator Meter - Form 8S  
13T Socket, Test Switch #TS10-0109

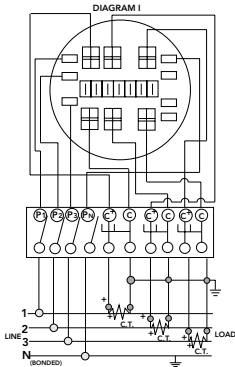

**DIAGRAM J**  
3 $\emptyset$ 4W "Y" with 3 P.T.'s & 3 C.T.'s  
3 Stator Meter - Form 9S  
13T Socket, Test Switch #TS10-0109

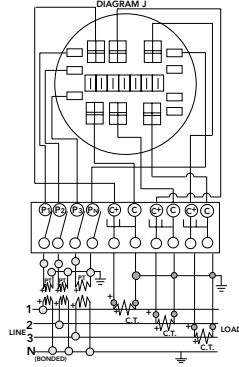

**Prewiring:** If standard factory prewiring is required, refer to wiring diagrams on this page. Determine appropriate diagram and send a copy with order. If custom factory prewiring is required, specify on order. Be sure to include meter socket catalog number, test switch make and catalog number, meter form number and provide a copy of your wiring diagram.



Please consult serving utility for their requirements prior to ordering or installing, as specifications and approvals vary by utility, and may require local electrical inspector approval. All installations must be installed by a licensed electrician and must comply with all national and local codes, laws and regulations. Milbank reserves the right to make changes in specifications and features shown without notice or obligation.

# Conduit, Ampacity & SCCR

## Reference Information

### MAXIMUM NUMBER OF CONDUCTORS IN CONDUIT

Table from 2008 NEC Code Reference: Rigid Metal Conduit

Type	Conductor Size (AWG/kcmil)	Conduit Trade Sizes (Inches)									
		1/2	3/4	1	1 1/4	1 1/2	2	2 1/2	3	3 1/2	4
THHN, THWN, THWN-2	12	9	16	26	46	62	102	146	225	301	387
	10	6	10	17	29	39	64	92	142	189	244
	8	3	6	9	16	22	37	53	82	109	140
	6	2	4	4	12	16	27	38	59	79	101
	4	1	2	4	7	10	16	23	36	48	62
	3	1	1	3	6	8	14	20	31	41	53
	2	1	1	3	5	7	11	19	26	34	44
	1	1	1	1	4	5	8	12	19	25	35
	1/0	1	1	1	3	4	7	10	16	21	27
	2/0	0	1	1	2	3	6	8	13	18	23
3/0	0	1	1	1	3	5	7	11	15	19	
4/0	0	1	1	1	2	4	6	9	12	16	
XHH, XHHW, XHHW-2	4	1	2	4	7	10	16	24	37	49	63
	2	1	1	3	5	7	12	17	26	35	45
	1/0	1	1	1	3	4	7	10	16	22	28
	2/0	0	1	1	2	3	6	9	13	18	23
	4/0	0	1	1	1	2	4	6	9	12	16
	250	0	0	1	1	1	3	5	7	10	13
	350	0	0	1	1	1	2	3	6	7	10
	500	0	0	0	1	1	1	2	4	5	7
750	0	0	0	0	1	1	1	3	4	5	

This table is for concentric stranded conductors only. For cables with compact conductors refer to NEC. Refer to latest NEC Code or Local Codes for updated requirements.

#### \* ALLOWABLE AMPACITIES OF INSULATED COPPER & \*\* ALUMINUM CONDUCTORS (3W IN CONDUIT) 75°C (167°F)

*CU		AL or **Cu-Clad AL	
A	B	A	C
18	-	-	-
16	-	-	-
14	20†	-	-
12	25†	12	20†
10	35†	10	30†
8	50	8	40
6	65	6	50
4	85	4	65
3	100	3	75
2	115	2	90
1	130	1	100
1/0	150	1/0	120
2/0	175	2/0	135
3/0	200	3/0	155
4/0	230	4/0	180
250	255	250	205
300	285	300	230
350	310	350	250
400	335	400	270
500	380	500	310
600	420	600	340
700	460	700	375
750	475	750	385

A = Size: AWG/MCM  
 \*B = Ampere Rating for Insulation Types:  
**FEPW, RH, RHW, THW, THWN, XHHW, USE, 2W.**  
 \*\*C = Ampere Rating for Insulation Types:  
**RH, RHW, THW, THWN, XHHW, USE**  
 (Per NEC table 310-16)

#### AMPACITY CORRECTION FACTORS

AMBIENT TEMP.C°	CORRECTION FACTOR	AMBIENT TEMP.F°
21 - 25	1.05	70 - 77
26 - 30	1.00	78 - 86
31 - 35	.94	87 - 95
36 - 40	.88	96 - 104
41 - 45	.82	105 - 113
46 - 50	.75	114 - 122
51 - 55	.67	123 - 131
56 - 60	.58	132 - 140
61 - 65	.53	141 - 158

Overall ampere ratings of U/L listed Milbank multiple position meter sockets are based on 2008 N.E.C. Handbook Article 220-84 and ANSI / UL-414 (except where restricted by line connector size.) These requirements provide for a diversity factor / demand factor being utilized in determining the overall (main bus / lug) rating of a gang socket. All Milbank U/L listed gang sockets meet or exceed these diversity factor/demand factor requirements. Standard overall ampacity ratings for U/L listed and non U/L listed gang sockets are as shown in the chart below. Ampere ratings of meter sockets are based on the meter socket being wired with 75° C insulated wire conductor, sized in accordance with Table 310-16 of the National Electric Code.

#### GANG SOCKET OVERALL AMPACITIES

NO. OF METER POSITIONS	100A / POS. AMPACITY	125A / POS. AMPACITY	150A / POS. AMPACITY	200A / POS. AMPACITY
2	200A	200A	200A	200A #
3	200A	225A	225A	270A
4	200A	250A	270A	360A
5	225A	285A	338A	450A
6	270A	330A	396A	528A

† Unless otherwise permitted elsewhere in the Code, the overcurrent protection for conductor types marked with an obelisk (†) shall not exceed 15 amps for 14 AWG, 20 amps for 12 AWG, and 30 amps for 10 AWG copper; or 15 amps for 12 AWG and 25 amps for 10 AWG aluminum and copper-clad aluminum after any correction factors for ambient temperature and number of conductors have been applied.

# Some constructions are rated at 400 amps overall. Contact your sales representative for more information. Refer to latest NEC Code or Local Codes for updated requirements.

Please consult serving utility for their requirements prior to ordering or installing, as specifications and approvals vary by utility, and may require local electrical inspector approval. All installations must be installed by a licensed electrician and must comply with all national and local codes, laws and regulations. Milbank reserves the right to make changes in specifications and features shown without notice or obligation.



### Important Note

In addition to national and local electrical codes, many utilities have specific requirements for metering equipment. Always consult the serving utility for their specifications and requirements prior to ordering or installing Milbank meter mounting equipment.

### Before Energizing

1. Give equipment a thorough visual examination to determine that:
  - A. No shipping or installation damage exists.
  - B. Proper clearances have been maintained.
  - C. All connections have been made.
  - D. Equipment is clean and dry.
2. Make a thorough examination to:
  - A. Verify tightness of all bolted connections (see table below).
  - B. Manually operate all circuit breakers, switches, relays, etc.
  - C. Check rigidity of all mountings, bus bars and components.
  - D. Use test equipment to check continuity of circuitry and integrity of insulation.
3. All switches and circuit breakers should be in the "off" position.
4. Verify that manual meter bypass (if applicable) is in non-bypass position.
5. Install cover and/or close doors.
6. If installation is not being energized at this time, follow "after-energizing" steps listed below. These steps will secure the installation in case of accidental energization.

### When Energizing

Use caution and follow established safety procedures:

- 1) Wear safety apparel.
- 2) Use safety equipment.
- 3) Take action to prevent injury to yourself and others in the event of failure of the installation.
- 4) Take action to prevent/decrease damage to property in the event of failure of the installation.
- 5) If you are unsure how to safely energize the installation, get someone who is knowledgeable to do it.

### After Energizing

Secure the installation:

- 1) To prevent accidental contact with energized parts, cover all openings with approved filler devices.
- 2) To prevent unauthorized access, secure all covers and/or doors with approved security devices.
- 3) Attach/post information to advise others of potential hazards associated with the installation.

### Recommended Torque for General Applications\*

Nominal Size	Joint Description		Head Type	Torque (Inch Lbs.)
	Screw	Nut		
10	Brass	Brass Nut or Extruded Hole	All	20-25 inch lbs.
10	Steel	Copper or Aluminum Busbar ≤ 1/8"	All	25-30 inch lbs.
10	Steel	Steel Nut or Extruded Hole; CU or AL Busbar > 1/8"	All	30-35 inch lbs.
12	Steel	Aluminum Extruded Hole	All	30-35 inch lbs.
12	Steel	Steel Nut or Extruded Hole	All	40-50 inch lbs.
1/4	Steel	Aluminum Extruded Hole	All	40-50 inch lbs.
1/4	Steel	Steel Nut or Extruded Hole; CU or AL Busbar	All	50-60 inch lbs.
5/16	Steel	Aluminum Extruded Hole	Hex	60-70 inch lbs.
5/16	Steel	Steel Nut or Extruded Hole; CU or AL Busbar	Hex	100-150 inch lbs.
3/8	Steel	Steel Nut	Hex	150-200 inch lbs.
1/2	Steel	Steel Nut	Hex	200-250 inch lbs.

\* Interior labels typically indicate the required torque for wire connectors and studs, and should be referenced first.  
**CU:** Copper  
**AL:** Aluminum



Please consult serving utility for their requirements prior to ordering or installing, as specifications and approvals vary by utility, and may require local electrical inspector approval. All installations must be installed by a licensed electrician and must comply with all national and local codes, laws and regulations. Milbank reserves the right to make changes in specifications and features shown without notice or obligation.

# Materials & Finishes

## Reference Information

### Materials

#### Steel Quality

---

The meter equipment listed in this catalog is made of galvanized steel (AISI\* G90) to afford the best possible weather proofing.  
\*American Iron and Steel Institute.

#### Steel Sheet

---

16 gauge, galvanized, sheet: 1 1/4 oz./ sq.ft. class zinc-coated. (AISI G90)  
14 gauge, galvanized, sheet: 1 1/4 oz./ sq.ft. class zinc-coated.

#### Aluminum Extrusion

---

Wire-Terminal: Alloy; 6061-T6, Tin-plated for CU/AL wire.  
Bus Bar: Alloy; 6101-O & 6063-O

#### Aluminum Sheet

---

3000 series aluminum sheet, H14, or 5052 series aluminum sheet, H32. Where applicable thicknesses range from .064-.125.

#### Copper Sheet & Bus

---

Electrolytic copper with tin plating in most applications.

#### Insulating Materials

---

- In most units, support bases for current-carrying components are molded from fiberglass reinforced high-strength, track resistant, thermoset polyester molding compounds.
- Clear or black safety shields and polarity barriers are molded from high-strength, track resistant, polycarbonate molding compounds.
- Various sheet insulating materials, as appropriate for the application are utilized in the fabrication of flat, formed and punched component parts and barriers.

### Finish

#### Process

---

Light gray state-of-the-art electrostatically applied powder paint offers a durable, non-fading finish. For further information concerning the chemical analysis of the weather resistant finish, please contact the factory.

#### Metal Fasteners

---

Zinc-coated with a chromate dip.

### Ratings & Compliance

#### Ratings & Compliance

---

All Milbank electrical enclosures in this catalog are rated "Type 3R Enclosure" unless specified otherwise on the product's page. All enclosures with a UL designation are constructed per the appropriate UL Standard and may be installed per the National Electric Code. UL procedure files associated with the UL Standards are listed as follows: Meter Sockets (UL 414, File E30202), Test Switches (UL 414, File E62531), Power Outlets (UL 231, File E90945), Panelboards (UL 67, File E32628) and Pullout Switches (UL 1429, File E133062). Additional standards are utilized as applicable: Meter Sockets (ANSI C12.7), Test Switches (ANSI C12.9) and Panelboards (NEMA PB-1).

Please consult serving utility for their requirements prior to ordering or installing, as specifications and approvals vary by utility, and may require local electrical inspector approval. All installations must be installed by a licensed electrician and must comply with all national and local codes, laws and regulations. Milbank reserves the right to make changes in specifications and features shown without notice or obligation.



6002.....	36	K3442 .....	36	Q230.....	34
6003.....	36	K3450 .....	32	Q230H.....	34
6116.....	36	K3865 .....	37	Q235.....	34
105J.....	41	K3865 .....	41	Q235H.....	34
182410-CTC1-SP.....	29	K3866 .....	37	Q240.....	34
243210-CTC1-SP.....	29	K4529 .....	37	Q240H.....	34
281815-CT3R-SP.....	29	K4802 .....	37	Q250.....	34
303515-CT3R-SP.....	29	K4977-EXT.....	37	Q250H.....	34
323210-CTC1-SP.....	29	K4977-INT.....	37	Q260.....	34
324210-CTC1-SP.....	29	K5022-INT.....	37	Q260H.....	34
324215-CT3R-SP.....	29	K5193 .....	32	Q270.....	34
363612-LC3R-SP-WB.....	29	K5194 .....	32	Q270H.....	34
403515-CT3R-SP.....	29	K5400-BRIDGE-1POS.....	32	Q280.....	34
425412-CTC1-SP.....	29	K5400-BRIDGE-2POS.....	32	Q280H.....	34
484812-CT3R-SP.....	29	K5415 .....	32	Q290.....	34
484812-CT3R-WB.....	29	K5T .....	32	Q290H.....	34
544215-CT3R-SP.....	29	K5T .....	37	QN2150.....	34
5T8K2 .....	37	K8180 .....	36	QN2150H.....	34
606015-CT3R-WB.....	29	M5-144.....	37	QN2150R.....	34
A7514 .....	35	MR-2.....	36	QN2150RH.....	34
A7515.....	35	MR2-SS.....	36	QN2200.....	34
A7516.....	35	MR-4.....	36	QN2200H.....	34
A7517.....	35	Q115.....	34	QN2200R.....	34
A7518.....	35	Q115H.....	34	QN2200RH.....	34
A7551.....	35	Q120.....	34	S6142-X-INV-DPL.....	13
A8110.....	35	Q120H.....	34	S8324.....	35
A8111.....	35	Q125.....	34	U1079-RRL-K3-BLG.....	13
A8112.....	35	Q125H.....	34	U1252-RRL-KK-K1-BLG-SLVG.....	25
A9064.....	35	Q130.....	34	U1252-X-KK-K3-BL.....	23
A-GP.....	36	Q130H.....	34	U1252-X-KK-K3-BLG.....	23
BL7499.....	37	Q135.....	34	U1252-X-KK-K3-DLC.....	25
CE136-CECHA.....	28	Q135H.....	34	U1252-X-KK-K3-DPL.....	23
CP-16PDMNT-CALT.....	41	Q140.....	34	U1253-RRL-KK-K1-BLG-SLVG.....	25
CP-24PDMNT-CALT.....	41	Q140H.....	34	U1253-X-KK-K3-BL.....	23
CP-ABK5/8.....	41	Q150.....	34	U1253-X-KK-K3-BLG.....	23
CP-PE-HOA-3POS.....	41	Q150H.....	34	U1253-X-KK-K3-DLC.....	25
CP-TC24H.....	41	Q160.....	34	U1254-RXL-KK-K1-BLG-SLVG.....	25
CP-TC7D.....	41	Q160H.....	34	U1254-X-KK-K3-BL.....	23
CP-TCWIRE.....	41	Q170.....	34	U1254-X-KK-K3-BLG.....	23
K1047.....	37	Q170H.....	34	U1254-X-KK-K3-DLC.....	25
K1190.....	37	Q2100.....	34	U1254-X-KK-K3-DPL.....	23
K1350.....	36	Q2100H.....	34	U1255 X-KK-K3-DLC.....	25
K1350L.....	36	Q2125.....	34	U1255-RXL-KK-K1-BLG-SLVG.....	25
K1539.....	36	Q2125H.....	34	U1255-X-KK-K3-BL.....	23
K1540.....	36	Q215.....	34	U1255-X-KK-K3-BLG.....	23
K1540L.....	36	Q215H.....	34	U1256-RXL-KK-K1-BLG-SLVG.....	25
K1541.....	36	Q220.....	34	U1256-X-KK-K3-BL.....	23
K3082.....	36	Q220H.....	34	U1256-X-KK-K3-BLG.....	23
K3083.....	36	Q225.....	34	U1256-X-KK-K3-DLC.....	25
K3441.....	36	Q225H.....	34	U1256-X-KK-K4-DPL.....	23



Please consult serving utility for their requirements prior to ordering or installing, as specifications and approvals vary by utility, and may require local electrical inspector approval. All installations must be installed by a licensed electrician and must comply with all national and local codes, laws and regulations. Milbank reserves the right to make changes in specifications and features shown without notice or obligation.



# Index

U1282-XL-KK-BLG .....	19	U5884-X-KK-BLG .....	26	U9314-XL-KK-DLC .....	22
U1283-XL-KK-BLG .....	19	U5885-X-KK-BL .....	26	U9551-R-5T9 .....	12
U1779-R-K3-BLG .....	13	U5885-X-KK-BLG .....	26	U9551-X-DPL .....	12
U1797-O-K3L-K2L-BLG .....	13	U5886-X-KK-BL .....	26	U9700-RRL-BLG .....	12
U1980-O-KK-BL .....	11	U5886-X-KK-BLG .....	26	U9701-RRL-BLG .....	12
U1980-O-KK-BLG .....	11	U5898-O-100-KK-BLG .....	16	UQFB-100 .....	33
U1980-O-KK-DPL .....	11	U5898-O-200-KK-BL .....	16	UQFB-100-X1 .....	33
U2692-XL-KK-BL .....	21	U5898-O-200-KK-BLG .....	16	UQFB-125 .....	33
U2693-XL-KK-BL .....	21	U5902-X-KK-BL .....	26	UQFB-125-X1 .....	33
U3000-O-2/K3L-BL .....	13	U5902-X-KK-BLG .....	26	UQFB-150 .....	33
U3126-O-KK-BLG .....	11	U5903-X-KK-BL .....	26	UQFB-150-X1 .....	33
U3126-O-KK-DLC .....	11	U5903-X-KK-BLG .....	26	UQFB-175 .....	33
U3786-O-BLG .....	12	U5904-X-KK-BL .....	26	UQFB-175-X1 .....	33
U3802 .....	6	U5904-X-KK-BLG .....	26	UQFB-200 .....	33
U3812 .....	6	U5905-X-KK-BL .....	26	UQFB-200-X1 .....	33
U3822-20GWR .....	7	U5905-X-KK-BLG .....	26	UQFBH-100 .....	33
U3832 .....	6	U5906-X-KK-BL .....	26	UQFBH-125 .....	33
U3862 .....	6	U5906-X-KK-BLG .....	26	UQFBH-150 .....	33
U3939-X .....	13	U5971-XL-200 .....	15	UQFBH-175 .....	33
U4029-X-DPL .....	12	U5990-O .....	29	UQFBH-200 .....	33
U4168-X-K7-BLG .....	14	U7021-RL-KK-BL .....	10	UQFBH-M-100 .....	33
U4367-XPFB-BLG .....	14	U7021-RL-KK-DLC .....	10	UQFBH-M-125 .....	33
U4413-O-KK-BL .....	11	U7021-RL-TG-KK-BLG .....	10	UQFBH-M-150 .....	33
U4413-O-KK-BLG .....	11	U7040-RL-KK-DPL .....	10	UQFBH-M-175 .....	33
U4413-O-KK-DPL .....	11	U7040-RL-TG-KK-BLG .....	10	UQFBH-M-200 .....	33
U4701-XL-BLG .....	12	U7274-YL-KK .....	9	UQFP-100 .....	33
U4881-O .....	8	U7421-RRL .....	12	UQFP-125 .....	33
U4881-O-50GB .....	8	U7423-RXL .....	12	UQFP-150 .....	33
U4881-O-60GB .....	8	U7487-RL-KK-BL .....	9	UQFP-175 .....	33
U4905-X-BLG* .....	13	U7487-RL-TG-KK-BLG .....	9	UQFP-200 .....	33
U4912-X-K3-BLG .....	13	U7487-YL-TG-KK-BLG .....	9	UQFPH-100 .....	33
U5136-O .....	32	U8032-XL-KK-BL .....	19	UQFPH-125 .....	33
U5136-O-100S .....	32	U8032-XL-KK-BLG .....	19	UQFPH-150 .....	33
U5136-O-200S .....	31	U8033-XL-KK-BL .....	19	UQFPH-175 .....	33
U5136-O-200S .....	32	U8033-XL-KK-BLG .....	19	UQFPH-200 .....	33
U5137-O .....	32	U8034-XL-KK-BL .....	19	UQFPH-M-100 .....	33
U5137-O-100S .....	32	U8034-XL-KK-BLG .....	19	UQFPH-M-125 .....	33
U5137-O-200S .....	32	U8035-XL-KK-BL .....	19	UQFPH-M-150 .....	33
U5168-XTL-100-KK-BL .....	16	U8035-XL-KK-BLG .....	19	UQFPH-M-175 .....	33
U5168-XTL-100-KK-BLG .....	16	U8036-XL-KK-BL .....	19	UQFPH-M-200 .....	33
U5168-XTL-200-KK-BL .....	16	U8036-XL-KK-BLG .....	19	UQFP-M-100 .....	33
U5168-XTL-200-KK-BLG .....	16	U8173-XL-KK-BLG .....	10	UQFP-M-125 .....	33
U5268-XTL-200-KK-BLG .....	16	U8212-XL-KK-BLG .....	18	UQFP-M-150 .....	33
U5767-X-200-CB .....	17	U8213-XL-KK-BLG .....	18	UQFP-M-175 .....	33
U5787-O-200-CB .....	17	U8214-XL-KK-BLG .....	18	UQFP-M-200 .....	33
U5882-X-KK-BL .....	26	U8215-XL-KK-BLG .....	18	USE-22-200-MB .....	15
U5882-X-KK-BLG .....	26	U8216-XL-KK-BLG .....	18	WBJ2150 .....	34
U5883-X-KK-BL .....	26	U8569-YL-KK-BLG .....	9	WBJ2200 .....	34
U5883-X-KK-BLG .....	26	U9312-XL-KK-DLC .....	22		
U5884-X-KK-BL .....	26	U9313-XL-KK-DLC .....	22		

Please consult serving utility for their requirements prior to ordering or installing, as specifications and approvals vary by utility, and may require local electrical inspector approval. All installations must be installed by a licensed electrician and must comply with all national and local codes, laws and regulations. Milbank reserves the right to make changes in specifications and features shown without notice or obligation.



---

---

---

---

---

---

---

---

---

---

---

---

---

---

---

---

---

---

---

---

---

---

---

---

---

---

---

---

---

---



Please consult serving utility for their requirements prior to ordering or installing, as specifications and approvals vary by utility, and may require local electrical inspector approval. All installations must be installed by a licensed electrician and must comply with all national and local codes, laws and regulations. Milbank reserves the right to make changes in specifications and features shown without notice or obligation.



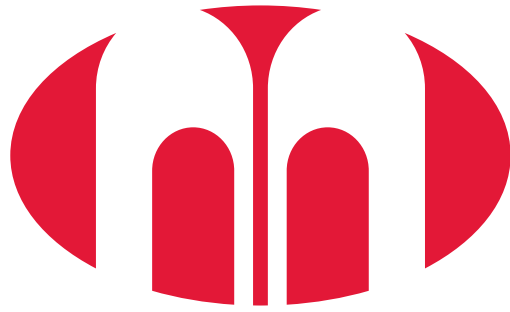

# MILBANK<sup>®</sup>

ENERGY AT WORK

