

MILBANK[®]
ENERGY AT WORK



ALLIANT ENERGY & MidAmerican Energy

Meter Mounting Equipment



Meter mounting
equipment approved for
use with Alliant Energy and
MidAmerican Energy..

Milbank Overview

Energy At Work Since 1927

Milbank designs and manufactures electrical solutions that move and manage power for the residential, commercial, industrial, utility and transportation sectors. With nearly a century of expertise in electrical engineering design and manufacturing, Milbank's portfolio includes metering equipment, enclosures and enclosed controls. Founded in 1927, Milbank is a family-owned, American manufacturer headquartered in Kansas City, Mo. For more information, please visit milbankworks.com.



Metering

Milbank has been a market leader in electrical metering equipment, setting the standard in quality, for 95 years and counting. There are hundreds of available configurations, including a range of sizes as well as various knockout, terminals and bypass options. Products also have a variety of selections for hubs, locks and connectors. Milbank has the socket you need with thousands of active products to meet your utility's requirements.



Enclosures

Milbank's line of enclosures include commercial junction boxes, panel mount enclosures, transformer cabinets, wireways and troughs. Enclosures are designed to meet or exceed industry standards. Each one is constructed with high-quality materials and built with superior craftsmanship. Each unit is engineered to protect controls and equipment from dust, dirt and other harmful elements, based on various NEMA ratings.



Enclosed Controls

Milbank doesn't just build empty enclosures, we can design and craft the entire package. Our enclosed controls are custom control equipment, engineered and built to your exact specifications. Milbank enclosed controls are an attractive, secure, Easy to install and cost-effective solution. These units can replace unsightly and insufficient strut and backboard structures when underground remote site power distribution and control equipment is required.



Please consult serving utility for their requirements prior to ordering or installing, as specifications and approvals vary by utility, and may require local electrical inspector approval. All installations must be installed by a licensed electrician and must comply with all national and local codes, laws and regulations. Milbank reserves the right to make changes in specifications and features shown without notice or obligation.

Air Conditioner Disconnects

30-60 Amps AC Disconnects	6
60 Amps AC Disconnect with 20 Amps GFCI Receptacle	7

Single Position Sockets

125-150 Amps, 4-5 Terminals, Ringless	8
200 Amps, 4-5 Terminals, Ringless	9-10
200 Amps, 4-5 Terminals, Lever Bypass, Ringless	11-12
200 Amps, 7 Terminals, Lever Bypass, Ringless	13
320 Amps, 4-5 Terminals, Lever Bypass, Ringless	14
320 Amps, 7 Terminals, Lever Bypass, Ringless	15

Meter Mains

100-200 Amps, 4-7 Terminals, Ringless	16-17
100-200 Amps, 4-5 Terminals, Ringless	18
200 Amps, 4-5 Terminals, Ringless	19
320 Amps, 4 Terminals, Lever Bypass, Ringless	20
200-400 Amps, 4-7 Terminals, Cold Sequence, Ringless	21

Multi-Position

100 Amps, 4-5 Terminals, Ringless	22-25
200 Amps, 4-5 Terminals, Ringless	26-27
200 Amps, 5 Terminals, Lever Bypass, Ringless	28-29
200 Amps, 7 Terminals, Lever Bypass, Ringless	30
125-200 Amps, 4 Terminals, Meter Mains, Ringless	31-33
200 Amps, 5 terminals, Lever Bypass, Ringless	37

Transformer Rated Sockets

20 Amps, 5-6 Terminals, Ringless	38
20 Amps, 8 Terminals, Ringless	39
20 Amps, 13 Terminals, Ringless	40
Test Switches	41-42

Cabinets

Outdoor Transformer Cabinets, NEMA 3R	43
Current Transformer Cabinets, Alliant Approved	44-47
Termination Cabinets, Alliant Approved	48-49
Disconnect Cabinets, Cable Closure Wireways, Alliant Approved	50-55
Current Transformer Cabinets, MidAmerican Approved	56-57

Please consult serving utility for their requirements prior to ordering or installing, as specifications and approvals vary by utility, and may require local electrical inspector approval. All installations must be installed by a licensed electrician and must comply with all national and local codes, laws and regulations. Milbank reserves the right to make changes in specifications and features shown without notice or obligation.



Meter Pedestals

200 Amps, 4-5 Terminals, Ringless	58
200 Amps, 4-5 Terminals, Lever Bypass, Ringless.....	59
200 Amps, 7 Terminals, Lever Bypass, Ringless.....	60

Meter Main Pedestal

100-200 Amps, 4 Terminals, Ringless	61
---	----

Meter Main with Load Center Pedestal

200 Amps, 4 Terminals, Ringless	62
300-320 Amps, 4-5 Terminals, Lever Bypass, Ringless.....	63

Temporary Power

100-125 Amps, 4 Terminals, Ringless	64
---	----

RV Products

Power Outlet Pedestals, 120/240V	65-66
Replacement Parts and Accessories.....	67-68
125 Amps, Surface-Mount, Metered and Unmetered	69
125 Amps, Direct Bury, Metered and Unmetered	70
Replacement Parts and Accessories	71-76

Miscellaneous

Terminal boxes, 100, 200 and 400 Amps.....	77
Enclosed controls.....	78-86
Circuit breakers.....	87-88
Accessories	89-91
NEMA commercial enclosures.....	92
Reference information	93-97
Index.....	98-102



Please consult serving utility for their requirements prior to ordering or installing, as specifications and approvals vary by utility, and may require local electrical inspector approval. All installations must be installed by a licensed electrician and must comply with all national and local codes, laws and regulations. Milbank reserves the right to make changes in specifications and features shown without notice or obligation.

Catalog Number Logic

How Our Product Catalog Numbers are Derived

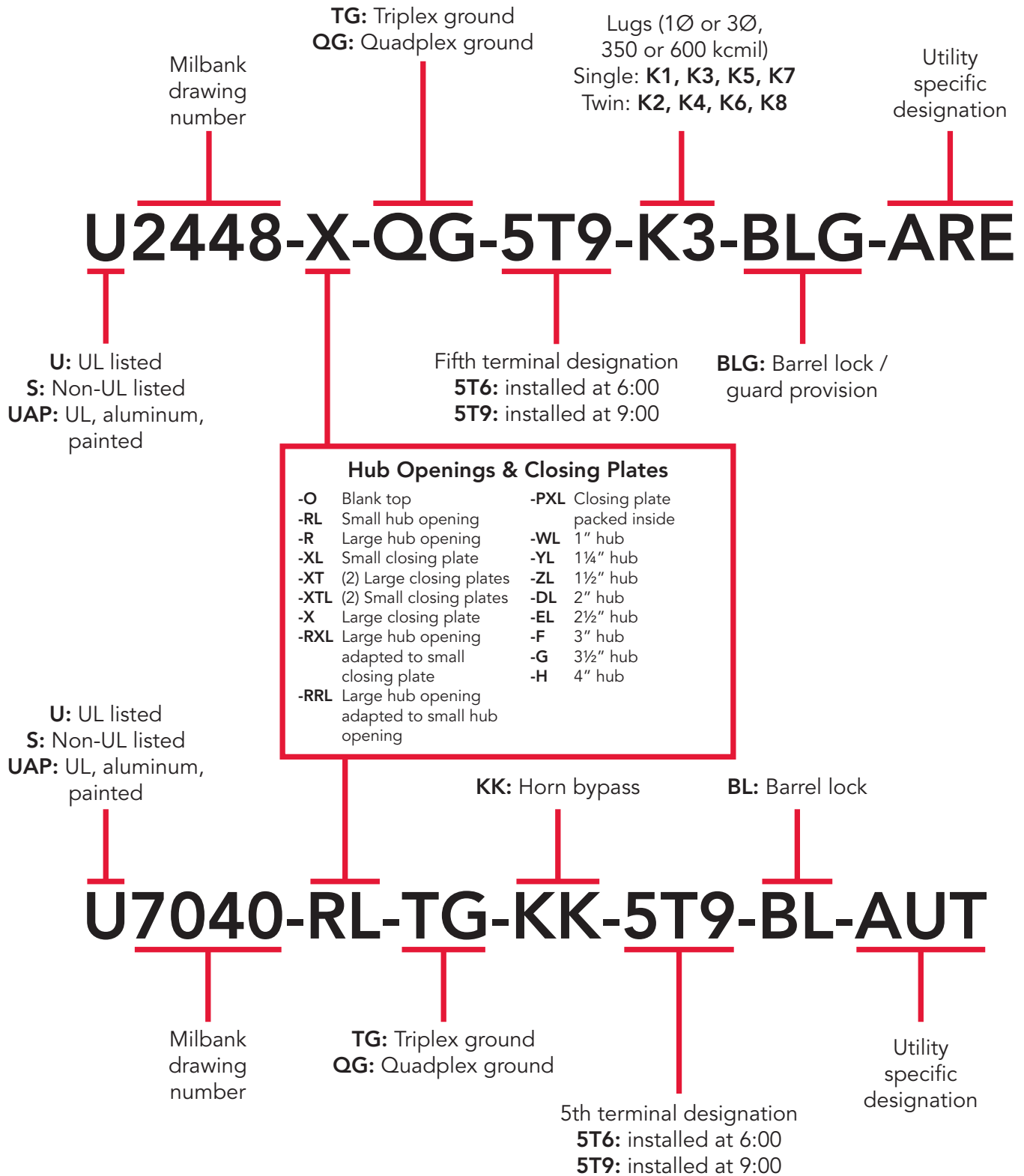

Please consult serving utility for their requirements prior to ordering or installing, as specifications and approvals vary by utility, and may require local electrical inspector approval. All installations must be installed by a licensed electrician and must comply with all national and local codes, laws and regulations. Milbank reserves the right to make changes in specifications and features shown without notice or obligation.



6

Air Conditioner Disconnects

30-60 Amps



U3802



U3812



U3832

Milbank's air conditioner disconnect has a removable hinged cover that makes wiring a breeze. Our compact design meets NEC wiring space requirements and also complies with NEC article 440-14. For safe working conditions, our disconnect pullers may be removed and reinstalled in the OFF position. Additionally, padlock provisions are included on the front cover. As with other Milbank products, our enclosure is constructed of G90 galvanized steel and electrostatically finished with an attractive, light gray, baked powder coating. Our epoxy/polyester resin blend offers a finish that is both durable and fade-resistant.

30-60 Amps | Air Conditioner Disconnects | 1Ø 240V

Catalog Number	Amps	Type	Max H.P.	Weight (lbs.)	Line/Load Wire Range		Ground Wire Range CU/AL	Dimensions			Wire Rating	
					CU	AL		D"	W"	H"	CU °C	AL °C
U3802	60	Non-Fusible	10	3.25	#14-#2	#12-#2	#14-4	2½	5	7½	60°/75°	60°/75°
U3812	60	Non-Auto	10	3.25	#14-#2	#12-#2	#14-4	2½	5	7½	60°/75°	60°/75°
U3832	30	Fusible	3	2.5	#14-#3	#14-#3	#14-3	2⅞	5	7	60°/75°	60°
U3862	60	Fusible	10	3.3	#14-#3	#14-#3	#14-3	2⅞	5	9	60°/75°	60°/75°

Notes

- UL-Listed as Enclosed Pullout Switch
- NEMA 3R
- Weather-resistant
- One-inch concentric knockouts



Please consult serving utility for their requirements prior to ordering or installing, as specifications and approvals vary by utility, and may require local electrical inspector approval. All installations must be installed by a licensed electrician and must comply with all national and local codes, laws and regulations. Milbank reserves the right to make changes in specifications and features shown without notice or obligation.

Air Conditioner Disconnects

60 Amps | With 20 Amps GFCI Receptacle



U3822-20GWR

Specifications

- Meets NEC #406.8 requirements
- Meets NEC #210.63 requirements
- UL-Listed as Power Outlet
- NEMA 3R
- In-use cover*
- Duplex ground connector
- One-inch concentric knockouts
- 1Ø, 240V
- 60 Amps, non-fused
- 20 Amps GFCI receptacle
- Reset/test button
- Weather-resistant

60 Amps | Air Conditioner Disconnect with 20 Amps GFCI Receptacle | 1Ø, 240V

Catalog Number	Type	Max H.P.	Weight (lbs.)	Line/Load Wire Range		Ground Wire Range CU/AL	Dimensions			Wire Rating	
				CU	AL		D"	W"	H"	CU °C	AL °C
U3822-20GWR	Non-Fusible	10	6	#14-#2	#12-#2	#14-4	4½	5¼	7½	60°/75°	60°/75°

Notes

- **Disconnect-pullers:** To ensure the safest conditions, Milbank disconnect pullers are reversible so they may be reinstalled in the OFF position.
 - **Padlock:** All units are designed with a padlock provision on the cover for security.
- *Rated as an in-use cover (cover may be closed with cords plugged into receptacle).

Please consult serving utility for their requirements prior to ordering or installing, as specifications and approvals vary by utility, and may require local electrical inspector approval. All installations must be installed by a licensed electrician and must comply with all national and local codes, laws and regulations. Milbank reserves the right to make changes in specifications and features shown without notice or obligation.



Single Position Sockets

125-150 Amps | 4-5 Terminals | Ringless | 600V



U7487-RL-TG-KK

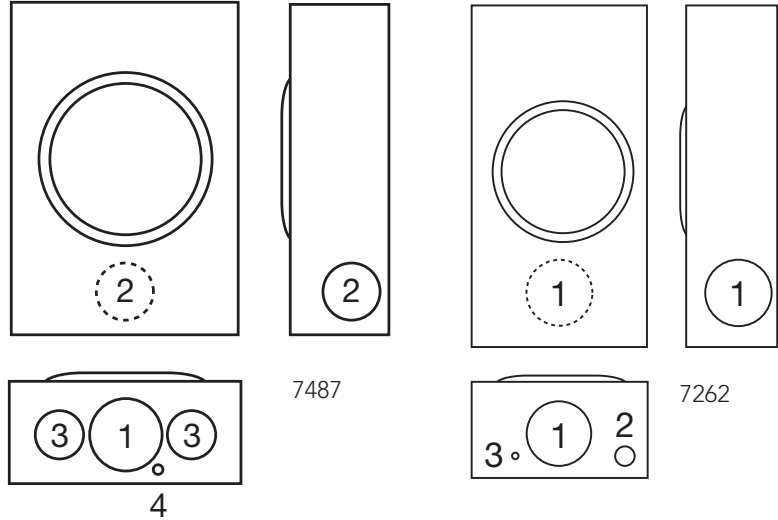

Alliant Approved | 125 Amps | Ringless | 600V

Catalog Number	Service	Terminals	Hub	Connectors CU/AL		Bypass	Dimensions			Knockouts			
				Line	Load		D"	W"	H"	1	2	3	4
U7487-RL-TG-KK-ALT	OH	4	H.O.	#6-2/0	#6-2/0	Horn	3 ⁵ / ₁₆	8	11 ¹ / ₂	2	1 ¹ / ₂	1 ¹ / ₄	1 ¹ / ₄
U7487-RL-TG-KK-5T	OH	5	H.O.	#6-2/0	#6-2/0	Horn	3 ⁵ / ₁₆	8	11 ¹ / ₂	2	1 ¹ / ₂	1 ¹ / ₄	1 ¹ / ₄

MidAmerican Approved | 4 Terminals | Ringless | 600V

Catalog Number	Amps	Service	Hub	Connectors CU/AL		Bypass	Dimensions			Knockouts			
				Line	Load		D"	W"	H"	1	2	3	4
U7487-RL-TG-KK	125	OH	H.O.	#6-2/0	#6-2/0	Horn	3 ⁵ / ₁₆	8	11 ¹ / ₂	2	1 ¹ / ₂	1 ¹ / ₄	1 ¹ / ₄
U7487-XL-TG-KK	125	OH/UG	C.P.	#6-2/0	#6-2/0	Horn	3 ⁵ / ₁₆	8	11 ¹ / ₂	2	1 ¹ / ₂	1 ¹ / ₄	1 ¹ / ₄
U7487-O-TG-KK	125	UG	Blank	#6-2/0	#6-2/0	Horn	3 ⁵ / ₁₆	8	11 ¹ / ₂	2	1 ¹ / ₂	1 ¹ / ₄	1 ¹ / ₄
U7262-RL-TG-KK	150	OH	H.O.	#6-350	#6-350	Horn	4 ¹ / ₈	8	15 ¹ / ₂	2 ¹ / ₂	1 ¹ / ₄ , 1 ¹ / ₂	1 ¹ / ₄	—

Notes

- **Hubs:** For proper hub selection, see the hub suffix chart on the accessories page.
- **Connectors:** Extruded aluminum connectors are tin-plated.
- **Fifth Terminal:** For field-installable fifth terminals for **U7262**, order **K5T**. For **U7487**, order **5T8K2**.



Please consult serving utility for their requirements prior to ordering or installing, as specifications and approvals vary by utility, and may require local electrical inspector approval. All installations must be installed by a licensed electrician and must comply with all national and local codes, laws and regulations. Milbank reserves the right to make changes in specifications and features shown without notice or obligation.

Single Position Sockets

200 Amps | 4-5 Terminals | Ringless | 600V



U7043-XL-TG-KK-ALT

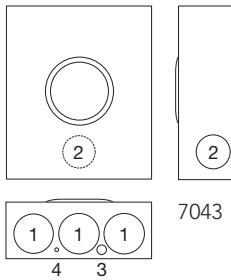

U7021-RL-TG-KK

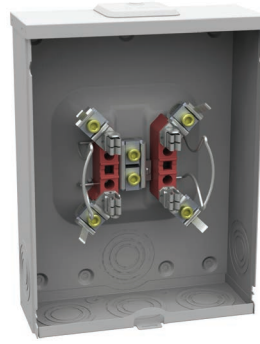
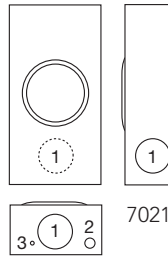

U1773-XL-TG-KK



U7040-XL-TG-KK-ALT

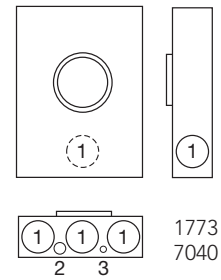

Alliant Approved | 200 Amps | Horn Bypass | Ringless | 600V

Catalog Number	Terminals	Service	Hub	Connectors CU/AL		Dimensions			Knockouts			
				Line	Load	D"	W"	H"	1	2	3	4
U7040-XL-TG-KK-ALT	4	OH	C.P.	#6-350	#6-350	4 $\frac{1}{8}$	11	14 $\frac{1}{2}$	2 $\frac{1}{2}$	$\frac{1}{4}$, $\frac{1}{2}$	$\frac{1}{4}$	—
U1773-XL-TG-KK	4	OH	C.P.	#6-350	#6-350	4 $\frac{1}{8}$	11	14 $\frac{5}{8}$	2 $\frac{1}{2}$	$\frac{1}{4}$, $\frac{1}{2}$	$\frac{1}{4}$	—
U7043-XL-TG-KK-ALT	4	OH	C.P.	#6-350	#6-350	4 $\frac{7}{8}$	13	15 $\frac{1}{2}$	3	2 $\frac{1}{2}$	$\frac{1}{4}$, $\frac{1}{2}$	$\frac{1}{4}$
U7040-XL-TG-KK-5T	5	OH	C.P.	#6-350	#6-350	4 $\frac{1}{8}$	11	14 $\frac{1}{2}$	2 $\frac{1}{2}$	$\frac{1}{4}$, $\frac{1}{2}$	$\frac{1}{4}$	—
U1773-XL-TG-KK-5T	5	OH	C.P.	#6-350	#6-350	4 $\frac{1}{8}$	11	14 $\frac{5}{8}$	2 $\frac{1}{2}$	$\frac{1}{4}$, $\frac{1}{2}$	$\frac{1}{4}$	—

MidAmerican Approved | 200 Amps | Horn Bypass | Ringless | 600V

Catalog Number	Terminals	Service	Hub	Connectors CU/AL		Dimensions			Knockouts			
				Line	Load	D"	W"	H"	1	2	3	4
U7021-RL-TG-KK	4	OH	H.O.	#6-350	#6-350	4 $\frac{1}{8}$	8	15 $\frac{1}{2}$	2 $\frac{1}{2}$	$\frac{1}{4}$, $\frac{1}{2}$	$\frac{1}{4}$	—
U7040-RL-TG-KK	4	OH	H.O.	#6-350	#6-350	4 $\frac{1}{8}$	11	14 $\frac{1}{2}$	2 $\frac{1}{2}$	$\frac{1}{4}$, $\frac{1}{2}$	$\frac{1}{4}$	—
U7040-XL-TG-KK	4	OH	C.P.	#6-350	#6-350	4 $\frac{1}{8}$	11	14 $\frac{1}{2}$	3	2 $\frac{1}{2}$	$\frac{1}{4}$, $\frac{1}{2}$	$\frac{1}{4}$
U7043-XL-TG-KK	4	OH/UG	C.P.	#6-350	#6-350	4 $\frac{7}{8}$	13	15 $\frac{1}{2}$	2 $\frac{1}{2}$	$\frac{1}{4}$, $\frac{1}{2}$	$\frac{1}{4}$	—
U7040-O-TG-KK	4	OH	Blank	#6-350	#6-350	4 $\frac{1}{8}$	11	14 $\frac{1}{2}$	3	2 $\frac{1}{2}$	$\frac{1}{4}$, $\frac{1}{2}$	$\frac{1}{4}$

Notes

- **Hubs:** For proper hub selection, see the hub suffix chart on the accessories page.
- **Fifth Terminal:** For field-installable fifth terminals, order **K5T**.
- **Connectors:** Extruded aluminum connectors are tin-plated.

Please consult serving utility for their requirements prior to ordering or installing, as specifications and approvals vary by utility, and may require local electrical inspector approval. All installations must be installed by a licensed electrician and must comply with all national and local codes, laws and regulations. Milbank reserves the right to make changes in specifications and features shown without notice or obligation.



1 □

Single Position Side Wireway Sockets

200 Amps | 4-5 Terminals | Ringless | 600V



U3850-O-TG-KK-ALT

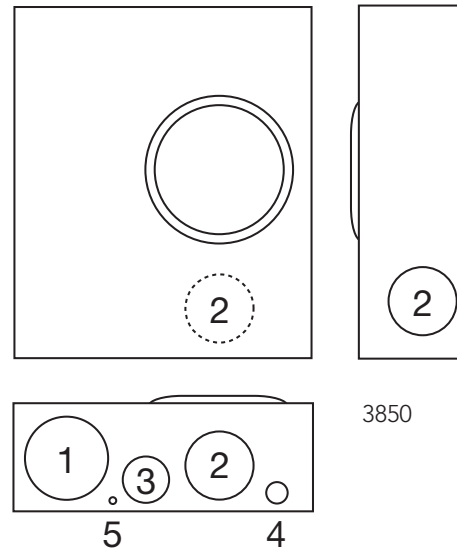

Alliant and MidAmerican Approved | 200 Amps | Horn Bypass | Ringless | 600V

Catalog Number	Terminals	Service	Hub	Connectors CU/AL		Dimensions			Knockouts				
				Line	Load	D"	W"	H"	1	2	3	4	5
U3850-O-TG-KK-5T	5	UG	Blank	#6-350	#6-350	4½	13	15¼	3	2½	1½	¼, ½	¼

Alliant Approved | 200 Amps | Horn Bypass | Ringless | 600V

Catalog Number	Terminals	Service	Hub	Connectors CU/AL		Dimensions			Knockouts				
				Line	Load	D"	W"	H"	1	2	3	4	5
U3850-O-TG-KK-ALT	4	UG	Blank	#6-350	#6-350	4½	13	15¼	3	2½	1½	¼, ½	¼

Notes

- **Hubs:** For proper hub selection, see the hub suffix chart on the accessories page.
- **Fifth Terminal:** For field-installable fifth terminal, order **K5T**.
- **Connectors:** Extruded aluminum connectors are tin-plated.



Please consult serving utility for their requirements prior to ordering or installing, as specifications and approvals vary by utility, and may require local electrical inspector approval. All installations must be installed by a licensed electrician and must comply with all national and local codes, laws and regulations. Milbank reserves the right to make changes in specifications and features shown without notice or obligation.

Single Position Lever Bypass

1 1

200 Amps | 4-5 Terminals | Ringless | 600V



U4801-XL-5T9

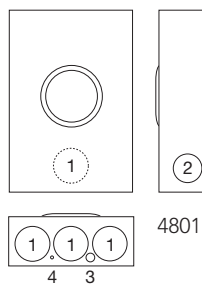

U6513-XL-BL-ALT

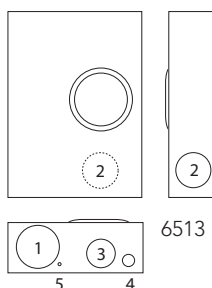

U4721-O-BL-ALT

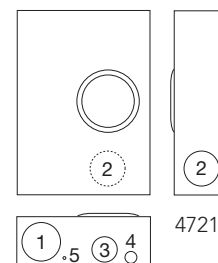

Alliant Approved | 200 Amps | Lever Bypass | Ringless | 600V

Catalog Number	Terminals	Service	Hub	Connectors CU/AL		Dimensions			Knockouts				
				Line	Load	D"	W"	H"	1	2	3	4	5
U4801-XL-ALT	4	OH	C.P.	#6-350*	#6-350	4 ²⁷ / ₃₂	13	19	3	2½	¼, ½	¼	—
U6513-XL-BL-ALT	4	OH/UG	C.P.	#6-350	#6-350	3¾	16	24¼	4	3½	2½	1	¼
U4721-O-BL-ALT	4	UG	Blank	#6-350	#6-350	5¾	16	22	4	3½	2½	1	¼
U4801-XL-5T9	5	OH	C.P.	#6-350*	#6-350	4 ²⁷ / ₃₂	13	19	3	2½	¼, ½	¼	—

Notes

- **Hubs:** For proper hub selection, see the hub suffix chart on the accessories page.
- **Connectors:** Extruded aluminum connectors are tin-plated.
- **Bypass:** The lever operates bypass device and supplies clamping action to meter spades.
- **Fifth Terminal:** For field-installable fifth terminal, order **K3866**.

*The line side wire size is restricted to 4/0.

Please consult serving utility for their requirements prior to ordering or installing, as specifications and approvals vary by utility, and may require local electrical inspector approval. All installations must be installed by a licensed electrician and must comply with all national and local codes, laws and regulations. Milbank reserves the right to make changes in specifications and features shown without notice or obligation.



Single Position Lever Bypass

200 Amps | 4-5 Terminals | Ringless | 600V

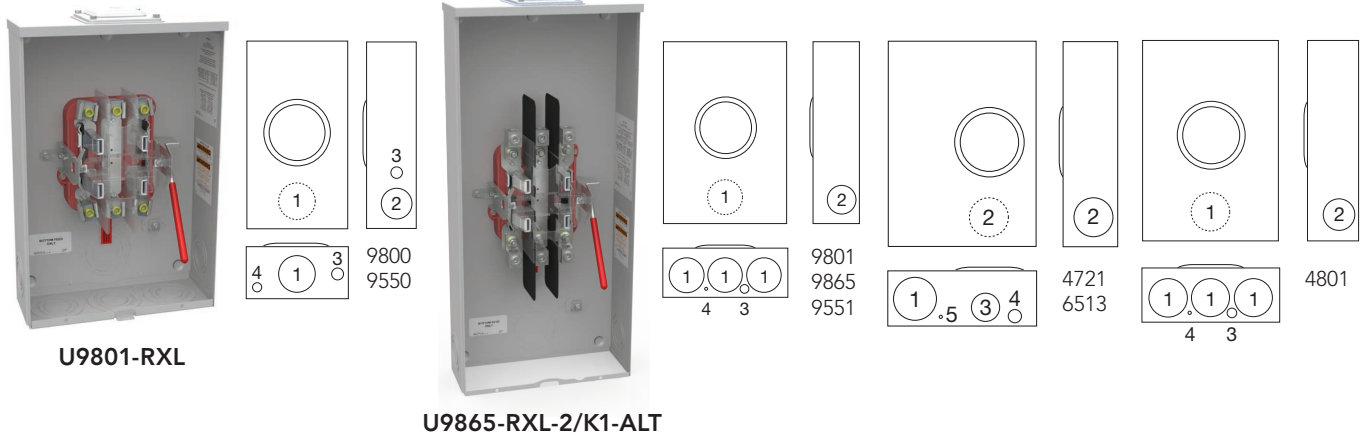

Alliant Approved | 200 Amps | Lever Bypass | 600V

Catalog Number	Terminals	Service	Hub	Connectors CU/AL		Dimensions			Knockouts				
				Line	Load	D"	W"	H"	1	2	3	4	5
U9800-RRL	4	OH	H.O.	#6-350	#6-350	4 ²⁷ / ₃₂	10	18½	3	2½	¾	¼, ½	—
U9865-RRL-K1	4	OH	H.O.	#6-350	¾" x 16 Studs	4 ²⁷ / ₃₂	13	28¼	3	2½	¼, ½	¼	—
U9865-RXL-2/K1-ALT	4	OH	H.O.	#6-350	#6-350	4 ²⁷ / ₃₂	13	28¼	3	2½	¼, ½	¼	—
U9800-RRL-5T9	5	OH	H.O.	#6-350	#6-350	4 ²⁷ / ₃₂	10	18½	3	2½	¾	¼, ½	—
U9865-RRL-5T9	5	OH	H.O.	¾" x 16 Studs	¾" x 16 Studs	4 ²⁷ / ₃₂	13	28¼	3	2½	¼, ½	¼	—

MidAmerican Approved | 200 Amps | Lever Bypass | 600V

Catalog Number	Terminals	Service	Hub	Connectors CU/AL		Dimensions			Knockouts			
				Line	Load	D"	W"	H"	1	2	3	4
U4721-O-BL-ALT	4	UGUG	Blank	#6-350	#6-350	4¾	16	22	4	3½	2½	1
U4801-XL	4	OH/UG	C.P.	#6-350	#6-350	4⅝	13	19	3	2½	½	¼
U9800-RRL	4	OH	H.O.	#6-350	#6-350	4 ²⁷ / ₃₂	10	18½	3	2½	¾	¼, ½
U9801-RRL	4	OH	H.O.	#6-350	#6-350	4 ²⁷ / ₃₂	13	19	3	2½	¼, ½	¼
U9801-RXL	4	OH/UG	C.P.	#6-350	#6-350	4 ²⁷ / ₃₂	13	19	3	2½	¼, ½	¼
U9865-RRL	4	OH/UG	H.O.	¾" x 16 Studs	¾" x 16 Studs	4 ²⁷ / ₃₂	13	28¼	3	2½	¼, ½	¼
U9865-RXL-2/K1-ALT	4	OH/UG	H.O.	#6-350	#6-350	4 ²⁷ / ₃₂	13	28¼	3	2½	¼, ½	¼
U6513-XL-BL-ALT	4	OH/UG		#6-350	#6-350	5¼	16	24¼	4	3½	2½	1
U9550-RRL	5	OH	H.O.	#6-350	#6-350	4 ²⁷ / ₃₂	10	18½	3	2½	¾	¼, ½
U9551-RXL	5	OH/UG	C.P.	#6-350	#6-350	4 ²⁷ / ₃₂	13	19	3	2½	¼, ½	¼

Notes

- **Hubs:** For proper hub selection, see the hub suffix chart on the accessories page.
- **Connectors:** Extruded aluminum connectors are tin-plated.
- **Fifth Terminal:** For field-installable fifth terminal for **U9800** and **U9865**, order **K3866**.



Please consult serving utility for their requirements prior to ordering or installing, as specifications and approvals vary by utility, and may require local electrical inspector approval. All installations must be installed by a licensed electrician and must comply with all national and local codes, laws and regulations. Milbank reserves the right to make changes in specifications and features shown without notice or obligation.

Single Position Lever Bypass

13

200 Amps | 7 Terminals | Ringless | 600V



U9700-RRL



U9701-RXL-ALT



U1493-X-ALT



U4910-O-BL-ALT

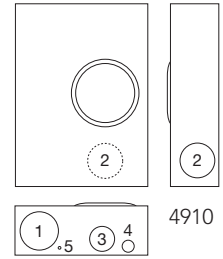
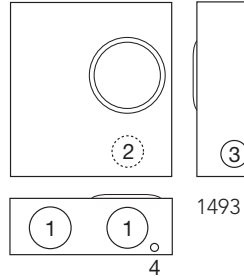
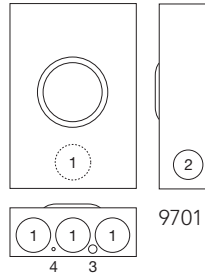
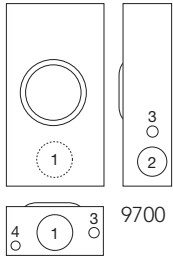

Alliant Approved | 200 Amps | Lever Bypass | 600V

Catalog Number	Terminals	Service	Hub	Connectors CU/AL		Dimensions			Knockouts				
				Line	Load	D"	W"	H"	1	2	3	4	5
U9700-RRL	7	OH	H.O.	#6-350	#6-350	4 ²⁷ / ₃₂	10	18½	3	2½	¾	¼, ½	—
U9701-RXL-ALT	7	OH	C.P.	#6-350*	#6-350	4 ²⁷ / ₃₂	13	19	3	2½	¼, ½	¼	—
U1493-X-ALT	7	OH/UG	C.P.	#6-350	#6-350	6	18	19¼	4	3½	2½	¼, ½	—
U4910-O-BL-ALT	7	UG	Blank	#6-350	#6-350	5¾	16	22	4	3½	2½	1	¼

MidAmerican Approved | 200 Amps | Lever Bypass | 600V

Catalog Number	Terminals	Service	Hub	Connectors CU/AL		Dimensions			Knockouts			
				Line	Load	D"	W"	H"	1	2	3	4
U9700-RRL	7	OH	H.O.	#6-350	#6-350	4 ²⁷ / ₃₂	10	18½	3	2½	¾	¼, ½
U9701-RXL	7	OH/UG	C.P.	#6-350	#6-350	4 ²⁷ / ₃₂	13	19	3	2½	¼, ½	¼

Notes

- **Hubs:** For proper hub selection, see the hub suffix chart on the accessories page.
- **Connectors:** Extruded aluminum connectors are tin-plated.
- **Bypass:** The lever operates bypass device and supplies clamping action to meter spades.

Please consult serving utility for their requirements prior to ordering or installing, as specifications and approvals vary by utility, and may require local electrical inspector approval. All installations must be installed by a licensed electrician and must comply with all national and local codes, laws and regulations. Milbank reserves the right to make changes in specifications and features shown without notice or obligation.



Single Position Lever Bypass

320 Amps | 4-5 Terminals | Ringless | 600V



U1779-RRL-K3-K2-ALT

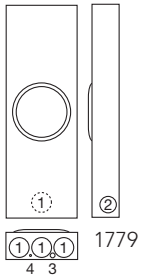

U1797-O-K3L-K2L

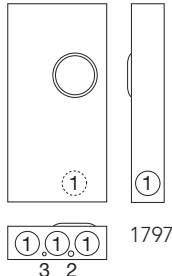

U2448-X

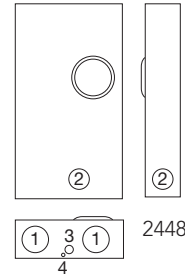

U3000-O-K3L-K2L-ALT

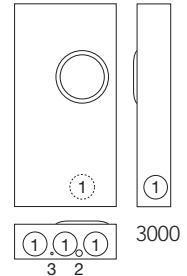

Alliant Approved | 320 Amps | Lever Bypass | Ringless | 600V

Catalog Number	Terminals	Service	Hub	Connectors CU/AL		Dimensions			Knockouts			
				Line	Load	D"	W"	H"	1	2	3	4
U1779-RRL-K3-K2-ALT	4	OH	H.O.	#4-600 or (2) 1/0-250	(2) #6-350	4 ²⁷ / ₃₂	13	38 ³ / ₄	3	2 ¹ / ₂	1/4, 1/2	1/4
U1797-O-K3L-K2L	4	UG	Blank	(1) #4-600 or (2) 1/0-250	(2) #6-350	4 ²⁷ / ₃₂	15	30	3	1/4, 1/2	1/4	—
U3000-O-K3L-K2L-ALT	4	UG	Blank	#4-600 or (2) 1/0-250	(2) #6-350	4 ²⁷ / ₃₂	15	30	3	1/4, 1/2	1/4	—

MidAmerican Approved | 320 Amps | Lever Bypass | Ringless | 600V

Catalog Number	Terminals	Service	Hub	Connectors CU/AL		Dimensions			Knockouts			
				Line	Load	D"	W"	H"	1	2	3	4
U1779-RRL-K3-K2	4	OH	H.O.	(1) #4-600 or (2) 1/0-250	(2) #6-350	4 ²⁷ / ₃₂	13	38 ³ / ₄	3	2 ¹ / ₂	1/4, 1/2	1/4
U1797-O-K3L-K2L	4	UG	Blank	(1) #4-600 or (2) 1/0-250	(2) #6-350	4 ²⁷ / ₃₂	15	30	3	1/4, 1/2	1/4	—
U2448-X	4	OH/UG	C.P.	3/8" x 16 Studs	3/8" x 16 Studs	6 ¹ / ₂	17 ³ / ₄	34 ¹ / ₈	4	3	1	1/4
U3000-O-K3L-K2L-ALT	4	UG	Blank	#4-600 or (2) 1/0-250	(2) #6-350	4 ²⁷ / ₃₂	15	30	3	1/4, 1/2	1/4	—
U2448-X-5T9	5	OH/UG	C.P.	3/8" x 16 Studs	3/8" x 16 Studs	6 ¹ / ₂	17 ³ / ₄	34 ¹ / ₈	4	3	1	1/4
U2124-X-5T9	5	UG	C.P.	3/8" x 16 Studs	3/8" x 16 Studs	5 ³ / ₄	16	30	4	3 ¹ / ₂	1	1/4

Notes

- **Hubs:** For proper hub selection, see the hub suffix chart on the accessories page.
- **Anti-Inversion Kit:** If anti-inversion kit is required, order catalog number **K4802** as extra.
- **Connectors:** Extruded aluminum connectors are tin-plated. See accessories page for lug kits.



Please consult serving utility for their requirements prior to ordering or installing, as specifications and approvals vary by utility, and may require local electrical inspector approval. All installations must be installed by a licensed electrician and must comply with all national and local codes, laws and regulations. Milbank reserves the right to make changes in specifications and features shown without notice or obligation.

Single Position Lever Bypass

15

320 Amps | 7 Terminals | Ringless | 600V

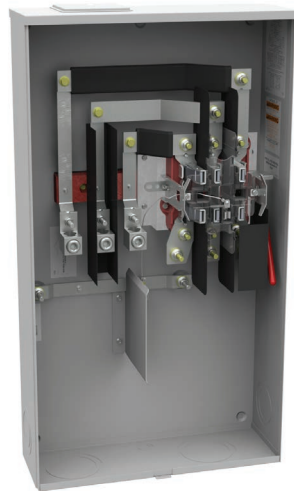

U2594-X-K7-ALT

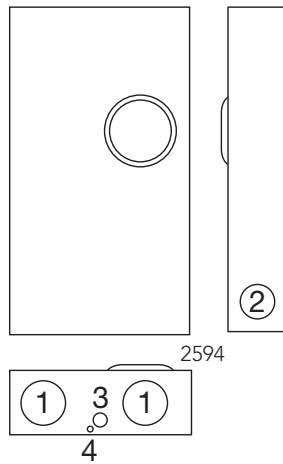

U2120-X-K7

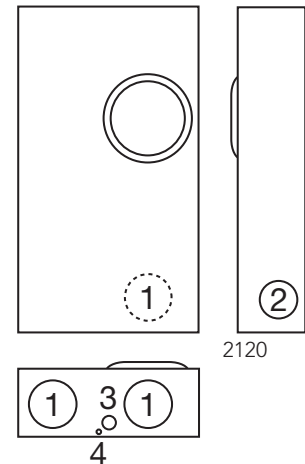

Alliant Approved | 320 Amps | Lever Bypass | Ringless | 600V

Catalog Number	Terminals	Service	Hub	Connectors CU/AL		Dimensions			Knockouts			
				Line	Load	D"	W"	H"	1	2	3	4
U2594-X-K7-ALT	7	OH/UG	C.P.	#4-600 or (2) 1/0-250	3/8" x 16 Studs	6 1/2	19	34 7/8	4	3	1	1/4
U2120-X-K7	7	UG	C.P.	#4-600 or (2) 1/0-250	3/8" x 16 Studs	6 1/2	17 3/4	31 3/4	4	3	1	1/4

MidAmerican Approved | 320 Amps | Lever Bypass | Ringless | 600V

Catalog Number	Terminals	Service	Hub	Connectors CU/AL		Dimensions			Knockouts			
				Line	Load	D"	W"	H"	1	2	3	4
U2594-X-K7	7	OH/UG	C.P.	3/8" x 16 Studs	3/8" x 16 Studs	6 1/2	19	34 7/8	4	3	1	1/4
U2120-X-K7	7	UG	C.P.	3/8" x 16 Studs	3/8" x 16 Studs	6 1/2	17 3/4	31 3/4	4	3	1	1/4

Notes

- **Hubs:** For proper hub selection, see the hub suffix chart on the accessories page.
- **Bypass:** The lever operates bypass device and supplies clamping action to meter spades.
- **Connectors:** Units supplied with 3/8"-16 hex head nuts with Belleville washers. For single lug connector kits, order as extra **K3082** (350 kcmil) or **K3441** (600 kcmil). For twin lug connectors, order as extra **K3442** (350 kcmil). Order two kits to cover both line and load.
- **Isolated Neutral:** For isolated neutral on **U2120**, order **K5977**.

Please consult serving utility for their requirements prior to ordering or installing, as specifications and approvals vary by utility, and may require local electrical inspector approval. All installations must be installed by a licensed electrician and must comply with all national and local codes, laws and regulations. Milbank reserves the right to make changes in specifications and features shown without notice or obligation.



100-200 Amps | 4-7 Terminals | Ringless | 240V



U3491-XL-200

U3491-XL-200-KK is MidAmerican Approved



U3791N-RXL-200-BL

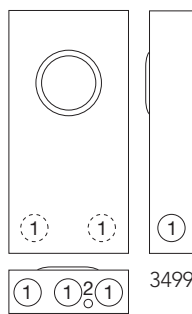

3499

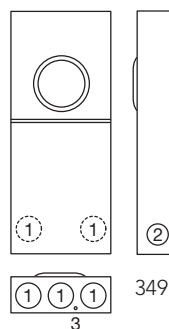

3491

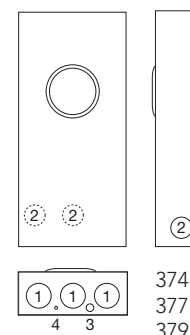

3741
3771
3791

MidAmerican Approved | 4 Terminals | Horn Bypass | Ringless

Catalog Number	Amps	Service	Hub	Connectors CU/AL		Dimensions			Knockouts			
				Line	Load	D"	W"	H"	1	2	3	4
U3499-XL-100-KK	100	OH/UG	C.P.	#6-2/0	#14-1/0	3 ³ / ₄	11	22	2	1/4, 1/2	—	—
U3491-XL-150-KK	150	OH/UG	C.P.	#6-350	#1-300	4 ¹ / ₈	12	29	2 ¹ / ₂	2	1/4	—
U3491-XL-200-KK	200	OH/UG	C.P.	#1-300	#1-300	4 ¹ / ₈	12	29	2 ¹ / ₂	2	1/4	—

MidAmerican Approved | 4-7 Terminals | Lever Bypass | Ringless

Catalog Number	Amps	Terminals	Service	Hub	Connectors CU/AL		Dimensions			Knockouts			
					Line	Load	D"	W"	H"	1	2	3	4
U3741-XL-100-BL	100	4	OH/UG	C.P.	#6-1/0	#6-1/0	4 ²⁷ / ₃₂	13	28	2 ¹ / ₂	2	1/4, 1/2	1/4
U3791N-RXL-200-BL	200	4	OH/UG	C.P.	#6-350	#1/0-300	4 ²⁷ / ₃₂	13	34	3	2 ¹ / ₂	1/4, 1/2	1/4
U3771-XL-100	100	7	OH/UG	C.P.	#6-350	#1-300	4 ⁷ / ₈	13	28	2 ¹ / ₂	2	1/4, 1/2	1/4

Notes

- **NEC 2020 Compliant:** All products are NEC 2020 Compliant.
- **Hubs:** For proper hub selection, refer to the hub suffix chart on the accessories page.
- **Breakers:** Bolt-on circuit breakers are factory-installed in the **U3491** series. **U3499** does not come with breakers unless specified on order and require plug-in style.
- **Short Circuit Current Rating:** 10K AIC. However, this rating is limited to the lowest interrupting capacity of any circuit breaker installed. Watthour meter not included in short circuit current rating.



Please consult serving utility for their requirements prior to ordering or installing, as specifications and approvals vary by utility, and may require local electrical inspector approval. All installations must be installed by a licensed electrician and must comply with all national and local codes, laws and regulations. Milbank reserves the right to make changes in specifications and features shown without notice or obligation.

Meter Mains

100-200 Amps | 7 Terminals | Ringless | 120/208V

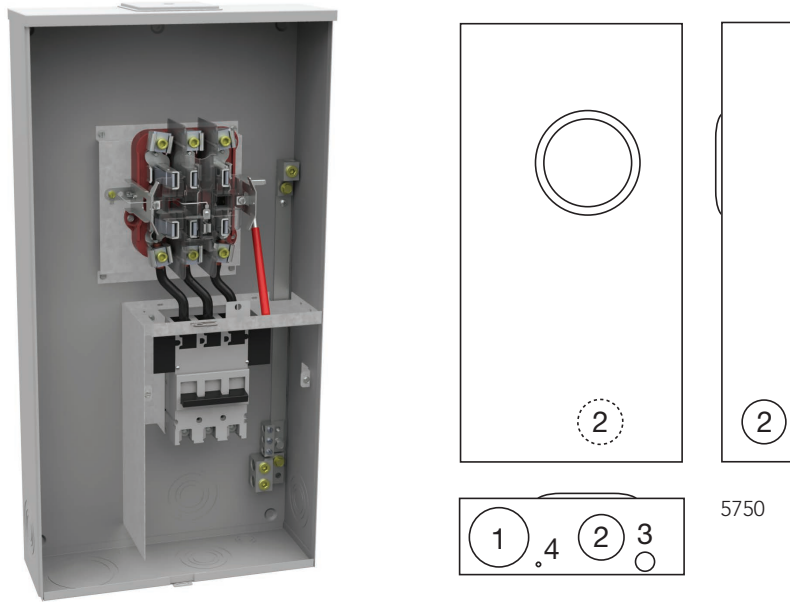

U5750-RXL-200-BL

MidAmerican Approved | 7 Terminals | Lever Bypass | Ringless

Catalog Number	Amps	Terminals	Service	Hub	Connectors CU/AL		Dimensions			Knockouts			
					Line	Load	D"	W"	H"	1	2	3	4
U5750-RXL-200-BL	200	7	OH/UG	C.P.	#6-350	1/0-300	5¾	17⅞	34	4	3	¼, ½	¼

Notes

- **NEC 2020 Compliant:** All products are NEC 2020 Compliant.
- **Hubs:** For proper hub selection, refer to the hub suffix chart on the accessories page.
- **Short Circuit Current Rating:** 10K AIC. However, this rating is limited to the lowest interrupting capacity of any circuit breaker installed. Watthour meter not included in short circuit current rating.

Please consult serving utility for their requirements prior to ordering or installing, as specifications and approvals vary by utility, and may require local electrical inspector approval. All installations must be installed by a licensed electrician and must comply with all national and local codes, laws and regulations. Milbank reserves the right to make changes in specifications and features shown without notice or obligation.



100-200 Amps | 4-5 Terminals | Ringless | 240V

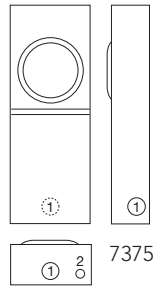

U7375-RL-KK

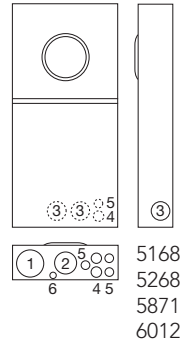

U5168-XTL-100-KK-ALT



U5268-XTL-200-KK

Alliant Approved | 100-200 Amps | Ringless | 240V

Catalog Number	Amps	Term.	Service	Hub	Connectors CU/AL - Line	Branch Circuits	Bypass	Dimensions			Knockouts					
								D"	W"	H"	1	2	3	4	5	6
U7375-RL-100-TG-KK	100	4	OH	H.O.	#6-350	—	Horn	4 ²⁷ / ₃₂	13	38 ³ / ₄	3	2 ¹ / ₂	1 ¹ / ₄ , 1 ¹ / ₂	1 ¹ / ₄	—	—
U5168-XTL-100-KK-ALT	100	4	OH/UG	C.P.	#6-350	10	Horn	4 ¹ / ₂	14 ¹ / ₈	30	3	2 ¹ / ₂	2	1	1 ¹ / ₂ , 3 ¹ / ₄	1 ¹ / ₄ , 1 ¹ / ₂
U6012-XL-100-K1-ALT	100	4	OH/UG	C.P.	#6-350	8	Lever	4 ¹ / ₂	14 ¹ / ₈	39 ¹ / ₄	3	2 ¹ / ₂	2	1	1 ¹ / ₂ , 3 ¹ / ₄	1 ¹ / ₄ , 1 ¹ / ₂
U5168-XTL-150-KK-ALT	150	4	OH/UG	C.P.	#6-350	8	Horn	4 ¹ / ₂	14 ¹ / ₈	30	3	2 ¹ / ₂	2	1	1 ¹ / ₂ , 3 ¹ / ₄	1 ¹ / ₄ , 1 ¹ / ₂
U5168-XTL-200-KK-ALT	200	4	OH/UG	C.P.	#6-350	8	Horn	4 ¹ / ₂	14 ¹ / ₈	30	3	2 ¹ / ₂	2	1	1 ¹ / ₂ , 3 ¹ / ₄	1 ¹ / ₄ , 1 ¹ / ₂
U5168-XTL-200-KK-5T	200	5	OH/UG	C.P.	#6-350	8	Horn	4 ¹ / ₂	14 ¹ / ₈	30	3	2 ¹ / ₂	2	1	1 ¹ / ₂ , 3 ¹ / ₄	1 ¹ / ₄ , 1 ¹ / ₂
U5268-XTL-150-KK	150	4	OH	C.P.	#6-350	20	Horn	4 ¹ / ₂	14 ¹ / ₈	30	3	2 ¹ / ₂	2	1	1 ¹ / ₂ , 3 ¹ / ₄	1 ¹ / ₄ , 1 ¹ / ₂
U5268-XTL-200-KK	200	4	OH	C.P.	#6-350	20	Horn	4 ¹ / ₂	14 ¹ / ₈	30	3	2 ¹ / ₂	2	1	1 ¹ / ₂ , 3 ¹ / ₄	1 ¹ / ₄ , 1 ¹ / ₂

MidAmerican Approved | 100-200 Amps | 4 Terminals | Ringless | 240V

Catalog Number	Amps	Service	Hub	Connectors CU/AL - Line	Branch Circuits	Bypass	Dimensions			Knockouts					
							D"	W"	H"	1	2	3	4	5	6
U5168-XTL-100-KK	100	OH/UG	C.P.	#6-350	10	Horn	4 ¹ / ₂	14 ¹ / ₈	30	3	2 ¹ / ₂	2	1	1 ¹ / ₂ , 3 ¹ / ₄	1 ¹ / ₄ , 1 ¹ / ₂
U5871-XL-100	100	OH/UG	C.P.	#6-350	8	Lever	4 ¹ / ₂	14 ¹ / ₈	32	3	2 ¹ / ₂	2	1	1 ¹ / ₂ , 3 ¹ / ₄	1 ¹ / ₄ , 1 ¹ / ₂
U5168-XTL-150-KK	150	OH/UG	C.P.	#6-350	8	Horn	4 ¹ / ₂	14 ¹ / ₈	30	3	2 ¹ / ₂	2	1	1 ¹ / ₂ , 3 ¹ / ₄	1 ¹ / ₄ , 1 ¹ / ₂
U5168-XTL-200-KK	200	OH/UG	C.P.	#6-350	8	Horn	4 ¹ / ₂	14 ¹ / ₈	30	3	2 ¹ / ₂	2	1	1 ¹ / ₂ , 3 ¹ / ₄	1 ¹ / ₄ , 1 ¹ / ₂
U5268-XTL-150-KK	150	OH/UG	C.P.	#6-350	20	Horn	4 ¹ / ₂	14 ¹ / ₈	30	3	2 ¹ / ₂	2	1	1 ¹ / ₂ , 3 ¹ / ₄	1 ¹ / ₄ , 1 ¹ / ₂
U5268-XTL-200-KK	200	OH/UG	C.P.	#6-350	20	Horn	4 ¹ / ₂	14 ¹ / ₈	30	3	2 ¹ / ₂	2	1	1 ¹ / ₂ , 3 ¹ / ₄	1 ¹ / ₄ , 1 ¹ / ₂

Notes

- **NEC 2020 Compliant:** All products are NEC 2020 Compliant.
- **Hubs:** For proper hub selection, refer to the hub suffix chart on the accessories page.
- **Fifth Terminal:** For field-installable fifth terminal, order **K5T**.
- **Breakers:** Rated 22K AIC with Milbank **QN2200RH** main installed.
- **Interlock Kit:** For generator auxiliary circuit breaker interlock, order **K5815** for large QN with small frame Q; order **K5820** for large frame QN with large frame QN; order **K5830** for small frame Q to small frame Q. See accessories page.
- **Sub Feed Lugs:** #6-350 sub feed lugs provided on 8 circuit interior. Not available on 20 circuit interior.



Please consult serving utility for their requirements prior to ordering or installing, as specifications and approvals vary by utility, and may require local electrical inspector approval. All installations must be installed by a licensed electrician and must comply with all national and local codes, laws and regulations. Milbank reserves the right to make changes in specifications and features shown without notice or obligation.

Meter Mains

200 Amps | 4-5 Terminals | Ringless | 240V

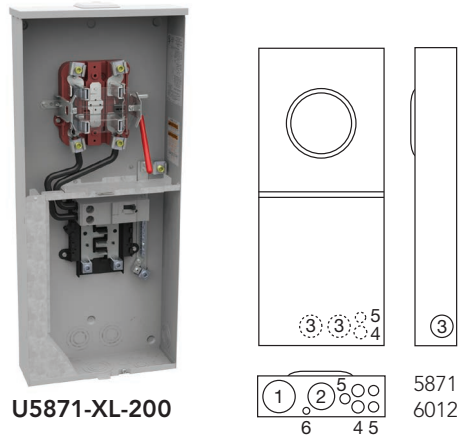

U5871-XL-200

Alliant Approved | 200 Amps | Lever Bypass | Ringless

Catalog Number	Terminals	Service	Hub	Connectors CU/AL		Dimensions			Knockouts					
				Line	Load	D"	W"	H"	1	2	3	4	5	6
U5871-XL-200	4	OH	C.P.	#6-350	CB	4½	14⅞	33½	3	2½	2	1	½,¾	¼,½
U6012-XL-200-K1-ALT	4	OH/UG	C.P.	#6-350	CB	4½	14⅞	39½	3	2½	2	1	½,¾	¼,½
U6012-XL-200-K1-5T9	5	OH/UG	C.P.	#6-350	CB	4½	14⅞	39½	3	2½	2	1	½,¾	¼,½

MidAmerican Approved | 200 Amps | Lever Bypass | Ringless

Catalog Number	Terminals	Service	Hub	Connectors CU/AL		Dimensions			Knockouts					
				Line	Load	D"	W"	H"	1	2	3	4	5	6
U5871-XL-100	4	OH/UG	C.P.	#6-350	CB	4½	14⅞	33½	3	2½	2	1	½,¾	¼,½
U5871-XL-200	4	OH/UG	C.P.	#6-350	CB	4½	14⅞	33½	3	2½	2	1	½,¾	¼,½
U6012-XL-200	4	OH/UG	C.P.	¾" x 16 Studs	CB	4½	14⅞	39½	3	2½	2	1	½,¾	¼,½
U6012-XL-200-K1-ALT	4	OH/UG	C.P.	#6-350	CB	4½	14⅞	39½	3	2½	2	1	½,¾	¼,½

Notes

- **NEC 2020 Compliant:** All products are NEC 2020 Compliant.
- **Breakers:** Units are factory supplied with **QN2200RH** breaker. Other amperage available. When applicable, replace suffix with desired amperage (-100, -125, -150).
- **Fifth Terminal:** For field-installable fifth terminal for **U5871** and **U6012**, order **K3865**.
- **Interlock Kit:** For generator auxiliary circuit breaker interlock, order **K5815** for large QN with small frame Q; order **K5820** for large frame QN with large frame QN; and order **K5830** interlock kit as small frame to small frame
- **Short Circuit Current Rating:** 22K AIC. However, this rating is limited to the lowest interrupting capacity of any circuit breaker installed. Watthour meter not included in rating.
- **Sub Feed Lugs:** #6-350 sub feed lugs provided.
- **U6012:** Line side lug for Mid-American energy approved unit not included.

Breaker Chart - 10K AIC (unless noted 22K)

Manufacturer	Cutler-Hammer	Siemens	GE (50 Amps Max)	Square D
125 Amps or Less	BR, HQP, QPGF	QP, QPH (22K)	THQL, THQL-GF	Homeline
150-200 Amps	—	QN, QNH (22K)	—	—

Please consult serving utility for their requirements prior to ordering or installing, as specifications and approvals vary by utility, and may require local electrical inspector approval. All installations must be installed by a licensed electrician and must comply with all national and local codes, laws and regulations. Milbank reserves the right to make changes in specifications and features shown without notice or obligation.



Lever Bypass Meter Mains

300-320 Amps | 4 Terminals | Ringless | 240V

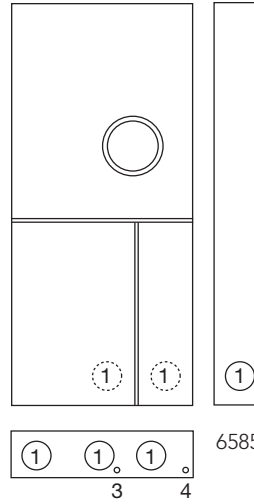

U6585-X-200-100-K3L-ALT

Alliant and Mid-American Approved | 4 Terminals | Lever Bypass | Ringless | 240V

Catalog Number	Amps	Service	Hub	Connectors CU/AL		Dimensions			Knockouts		
				Line	Load	D"	W"	H"	1	2	3
U6585-X-200-100-K3L-ALT	300/320	OH/UG	C.P.	#4-600 or (2) 1/0-250	#6-300	4 ²⁷ / ₃₂	15	42 ⁴ / ₉	3	1/4, 1/2	1/4
U6585-X-2-150-K3L-ALT	300/320	OH/UG	C.P.	#4-600 or (2) 1/0-250	#6-300	4 ²⁷ / ₃₂	15	42 ⁴ / ₉	3	1/4, 1/2	1/4
U6585-X-2/200-K3L-ALT*	400/320	OH/UG	C.P.	#4-600 or (2) 1/0-250	#6-300	4 ²⁷ / ₃₂	15	42 ⁴ / ₉	3	1/4, 1/2	1/4

Notes

- **NEC 2020 Compliant:** All products are NEC 2020 Compliant.
- **Residential applications:** products with 2/200 is only approved for residential applications.
- **Bypass:** The lever operates bypass device and supplies clamping action to meter spades.
- **Connectors:** Units supplied with 3/8"-16 hex head nuts with Belleville washers. For connector lug kits, order as extra from chart on accessories page. Lug kit is required for line side only.
- **Short Circuit Current Rating:** 22K AIC. However, this rating is limited to the lowest interrupting capacity of any circuit breaker installed. Watthour meter not included in short circuit current rating.

*2/200 Amps only approved for residential applications.



Please consult serving utility for their requirements prior to ordering or installing, as specifications and approvals vary by utility, and may require local electrical inspector approval. All installations must be installed by a licensed electrician and must comply with all national and local codes, laws and regulations. Milbank reserves the right to make changes in specifications and features shown without notice or obligation.

Lever Bypass Meter Mains

320 Amps | 4 Terminals | Ringless

21



U6605-X-2/200

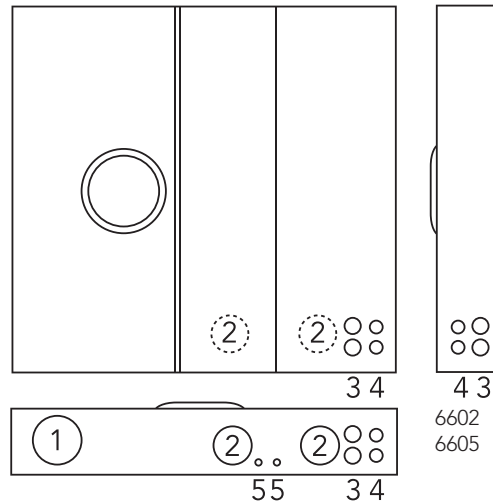

320 Amps | 4 Terminals | Lever Bypass | Ringless

Catalog Number	Service	Hub	Connectors CU/AL Line	Branch Circuits	Dimensions			Knockouts				
					D"	W"	H"	1	2	3	4	5
U6602-X-2/200-MLK-BL	OH/UG	C.P.	#6-350	12	6	29½	35	4	2½	1	½,¾	¼
U6605-X-2/200	OH/UG	C.P.	#6-350	12	6	29½	35	4	2½	1	½,¾	¼
U6605-2/200-MLK	OH/UG	C.P.	#6-350	12	6	29½	35	4	2½	1	½,¾	¼

Notes

- **NEC 2020 Compliant:** All products are NEC 2020 Compliant.
 - **Breakers:** All units come with two, 200 Amps main breakers.
 - **Side Bussed Units:** U6605 are side bussed.
 - **Fifth Terminal:** For field-installable fifth terminals, order catalog number K3865.
 - **Connectors:** Extruded aluminum connectors are tin-plated. See accessories page for lug kits.
- *2/200 Amps only approved for residential applications.

Please consult serving utility for their requirements prior to ordering or installing, as specifications and approvals vary by utility, and may require local electrical inspector approval. All installations must be installed by a licensed electrician and must comply with all national and local codes, laws and regulations. Milbank reserves the right to make changes in specifications and features shown without notice or obligation.



Cold Sequence Meter Mains

200-400 Amps | 4-7 Terminals | Ringless



U5767-X-200-CB

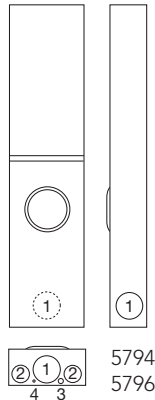

U5797-O-400-CB

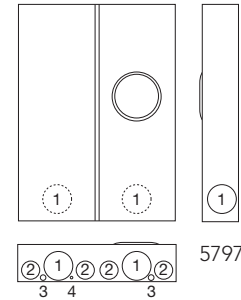
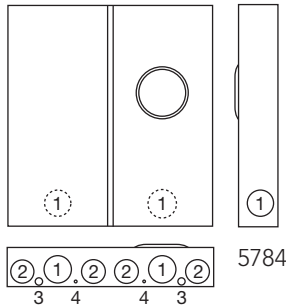
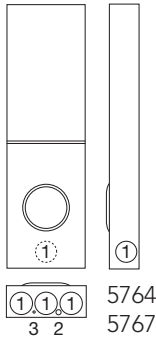

200 Amps | 4-7 Terminals | Circuit Breaker Disconnect Meter Socket

Catalog Number	Terminals	Service	Hub	Connectors CU/AL		Bypass	Dimensions			Knockouts			
				Line	Load		D"	W"	H"	1	2	3	4
U5764-X-200-CB	4	OH/UG	C.P.	1/0-350	#6-350	Lever	4 ²⁷ / ₃₂	13	43	4	2½	¼	—
U5764-X-200-5T-CB	5	OH/UG	C.P.	1/0-350	#6-350	Lever	4 ²⁷ / ₃₂	13	43	4	2½	¼	—
U5784-O-200-CB	5	UG	Blank	1/0-350	#6-350	Lever	4 ²⁷ / ₃₂	26	28	4	2½	¼	—
U5767-X-200-CB	7	OH/UG	C.P.	1/0-350	#6-350	Lever	4 ²⁷ / ₃₂	13	43	4	2½	1	½, ¾

400 Amps (320 Amps Continuous) | 4-7 Terminals | Circuit Breaker Disconnect Meter Socket

Catalog Number	Terminals	Service	Hub	Connectors CU/AL		Bypass	Dimensions			Knockouts			
				Line/Load			D"	W"	H"	1	2	3	4
U5794-X-400-CB	4	OH	C.P.	(2) 3/0-500		Lever	6	13	56	4	2½	¼, ½	¼
U5797-O-400-CB	4	UG	Blank	(2) 3/0-500		Lever	6	26	36	4	2½	¼, ½	¼
U5794-X-400-5T-CB	5	OH	C.P.	(2) 3/0-500		Lever	6	13	56	4	2½	¼, ½	¼
U5796-X-400-CB	7	OH	C.P.	(2) 3/0-500		Lever	6	13	56	4	2½	¼, ½	¼

Notes

- **Hubs:** For proper hub selection, refer to the hub suffix chart on the accessories page.
- **Voltage:** 200 Amps circuit breaker units are rated 240V at 65K AIC, 480V at 35K AIC and 600V at 22K AIC. 400 Amps circuit breaker units are rated at 600V at 10K AIC.



Please consult serving utility for their requirements prior to ordering or installing, as specifications and approvals vary by utility, and may require local electrical inspector approval. All installations must be installed by a licensed electrician and must comply with all national and local codes, laws and regulations. Milbank reserves the right to make changes in specifications and features shown without notice or obligation.

Multi-Position Sockets

100 Amps | 4-5 Terminals | Ringless | 300V



U7363-RL-KK

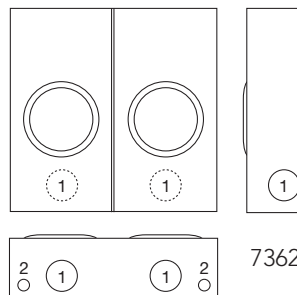

7362

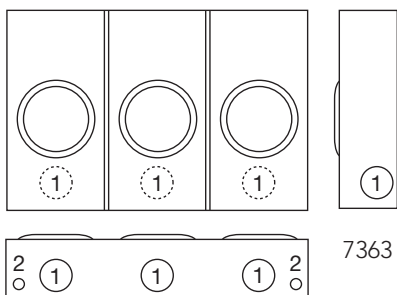

7363

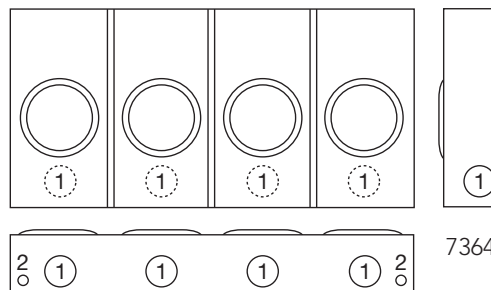

7364

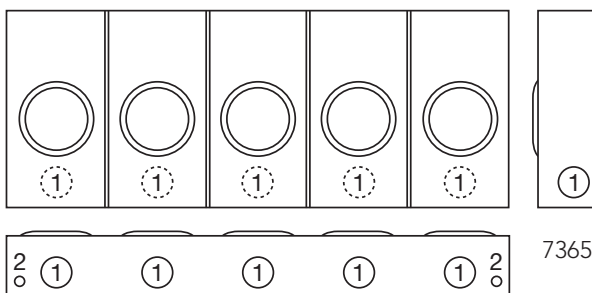

7365

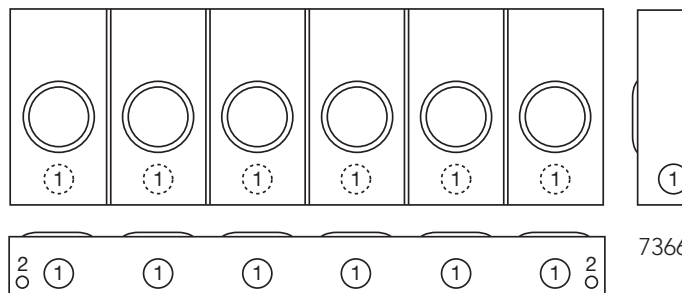

7366

Alliant Approved | 100 Amps per Position | Horn Bypass | Ringless

Catalog Number	Positions	Service	Terminals	Hub	Connectors CU/AL		Dimensions			Knockouts	
					Line	Load	D"	W"	H"	1	2
U7362-RL-KK	2	OH	4	H.O.	#6-350	#6-2/0	4½	16⅝	16	2½	¼, ½
U7362-RL-KK-5T9	2	OH	5	H.O.	#6-350	#6-2/0	4½	16⅝	16	2½	¼, ½
U7363-RL-KK	3	OH	4	H.O.	#6-350	#6-2/0	4½	24½	16	2½	¼, ½
U7364-RL-KK	4	OH	4	H.O.	#6-350	#6-2/0	4½	32⅞	16	2½	¼, ½
U7365-RL-KK	5	OH	4	H.O.	#6-350	#6-2/0	4½	40⅞	16	2½	¼, ½
U7366-RL-KK	6	OH	4	H.O.	#6-350	#6-2/0	4½	49⅞	16	2½	¼, ½

Notes

- **Hub:** For proper hub selection, refer to the hub suffix chart on the accessories page. A hub opening is supplied at each end and the extra opening is closed with a closing plate as standard.
- **Connectors:** Extruded aluminum connectors are tin-plated.

Please consult serving utility for their requirements prior to ordering or installing, as specifications and approvals vary by utility, and may require local electrical inspector approval. All installations must be installed by a licensed electrician and must comply with all national and local codes, laws and regulations. Milbank reserves the right to make changes in specifications and features shown without notice or obligation.





U8212-XL

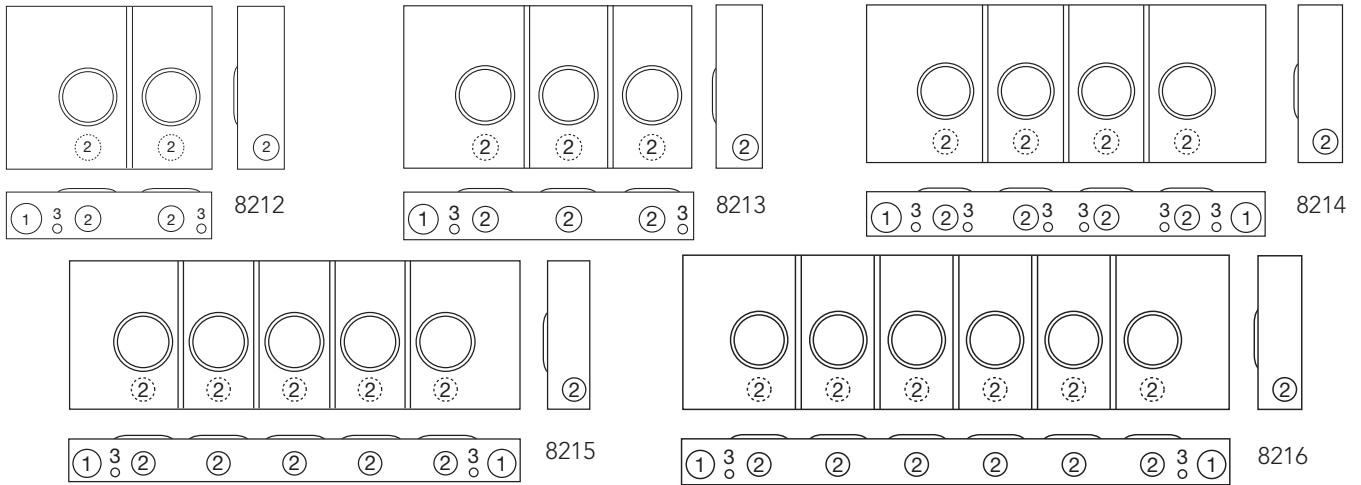

MidAmerican Approved | 100 Amps per Position | 4 Terminals | Ringless

Catalog Number	Positions	Service	Hub	Connectors CU/AL		Dimensions			Knockouts		
				Line	Load	D"	W"	H"	1	2	3
U8212-RL-KK	2	OH	H.O.	#6-350	#6-2/0	4½	20 ⁵ / ₁₆	16	2½	2	¼, ½
U8212-XL-KK	2	OH/UG	C.P.	#6-350	#6-2/0	4½	20 ⁵ / ₁₆	16	2½	2	¼, ½
U8213-RL-KK	3	OH	H.O.	#6-350	#6-2/0	4½	28½	16	2½	2	¼, ½
U8213-XL-KK	3	OH/UG	C.P.	#6-350	#6-2/0	4½	28½	16	2½	2	¼, ½
U8214-RL-KK	4	OH	H.O.	#6-350	#6-2/0	4½	40 ¹¹ / ₁₆	16	2½	2	¼, ½
U8214-XL-KK	4	OH/UG	C.P.	#6-350	#6-2/0	4½	40 ¹¹ / ₁₆	16	2½	2	¼, ½
U8215-RL-KK	5	OH	H.O.	#6-350	#6-2/0	4½	48 ⁷ / ₈	16	2½	2	¼, ½
U8215-XL-KK	5	OH/UG	C.P.	#6-350	#6-2/0	4½	48 ⁷ / ₈	16	2½	2	¼, ½
U8216-RL-KK	6	OH	H.O.	#6-350	#6-2/0	4½	57 ¹ / ₁₆	16	2½	2	¼, ½
U8216-XL-KK	6	OH/UG	C.P.	#6-350	#6-2/0	4½	57 ¹ / ₁₆	16	2½	2	¼, ½

Notes

- **Hub:** For proper hub selection, refer to the hub suffix chart on the accessories page.
- **Fifth Terminals:** For field-installable fifth terminal, order **5T8K2** (6 o'clock position) and **K9959** (9 o'clock position).
- **Connectors:** Extruded aluminum connectors are tin-plated.



Please consult serving utility for their requirements prior to ordering or installing, as specifications and approvals vary by utility, and may require local electrical inspector approval. All installations must be installed by a licensed electrician and must comply with all national and local codes, laws and regulations. Milbank reserves the right to make changes in specifications and features shown without notice or obligation.

Multi-Position Sockets

100 Amps | 4 Terminals | Ringless | 300V

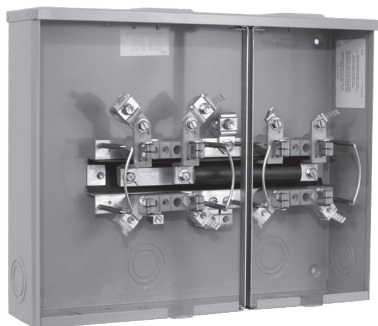

L572-XL-KK

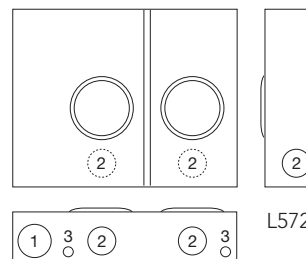

L572

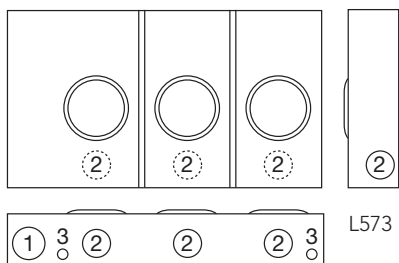

L573

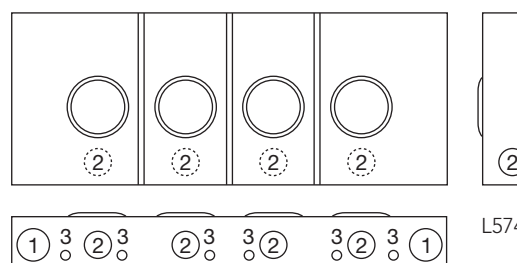

L574

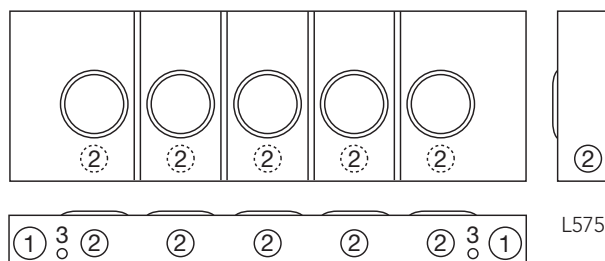

L575

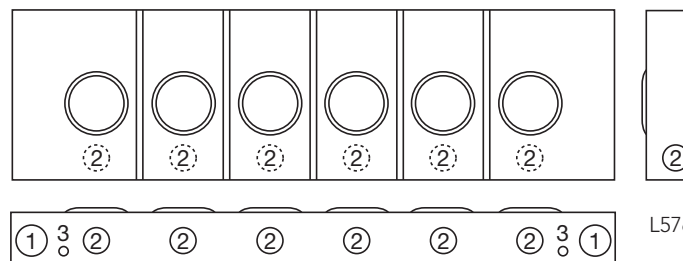

L576

100 Amps per Position | 4 Terminals | Ringless | 1Ø3W

Catalog Number	Positions	Service	Hub	Connectors CU/AL		Bypass	Dimensions			Knockouts		
				Line	Load		D"	W"	H"	1	2	3
L572-XL-KK-CECHA	2	OH	C.P.	#6-350	#6-2/0	Horn	4½	20⅝	16	2½	2	¼, ½
L573-XL-KK-CECHA	3	OH	C.P.	#6-350	#6-2/0	Horn	4½	28½	16	2½	2	¼, ½
L574-XL-KK-CECHA	4	OH	C.P.	#6-350	#6-2/0	Horn	4½	40⅞	16	2½	2	¼, ½
L575-XL-KK-CECHA	5	OH	C.P.	#6-350	#6-2/0	Horn	4½	48⅞	16	2½	2	¼, ½
L576-XL-KK-CECHA	6	OH	C.P.	#6-350	#6-2/0	Horn	4½	57⅞	16	2½	2	¼, ½

Notes

- **Hub:** For proper hub selection, refer to the hub suffix chart on the accessories page.
- **Fifth Terminal:** For field-installable fifth terminal, order **5T8K2** (6 o'clock position) or **K9959** (9 o'clock position).
- **Connectors:** Extruded aluminum connectors are tin-plated.

Please consult serving utility for their requirements prior to ordering or installing, as specifications and approvals vary by utility, and may require local electrical inspector approval. All installations must be installed by a licensed electrician and must comply with all national and local codes, laws and regulations. Milbank reserves the right to make changes in specifications and features shown without notice or obligation.





U8032-XL-KK

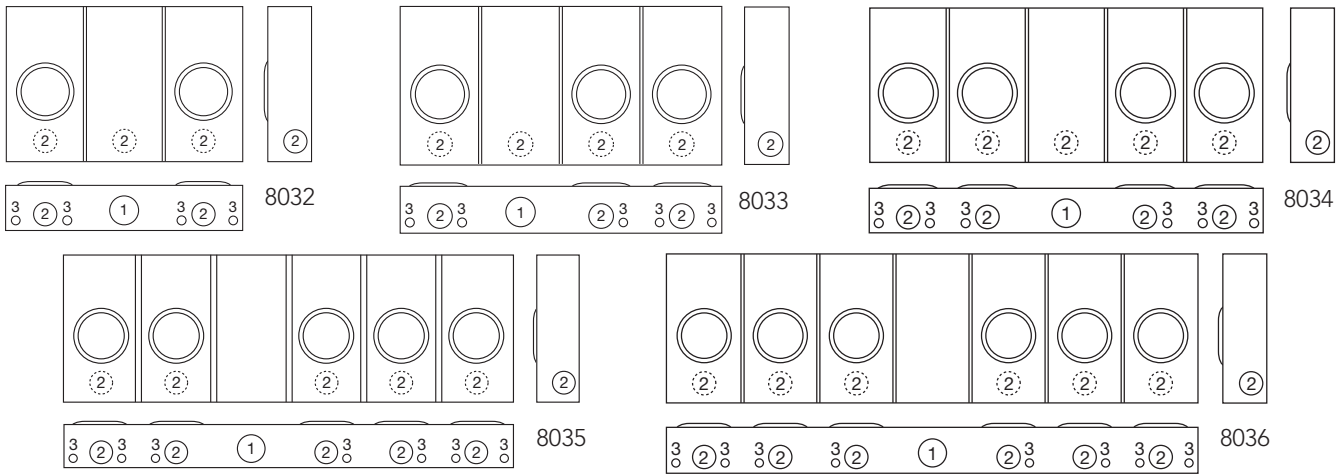

100 Amps per Position | Center Wireway | Ringless

Approval	Catalog Number	Positions	Terminals	Service	Hub	Connectors CU/AL		Dimensions			Knockouts		
						Line	Load	D"	W"	H"	1	2	3
MAE	U8032-RL-KK	2	4	OH	H.O.	#6-350	#6-2/0	4½	24½	16	2½	2	½
ALT, MAE	U8032-XL-KK	2	4	OH/UG	C.P.	#6-350	#6-2/0	4½	24½	16	2½	2	½
ALT	U8032-XL-KK-5T9	2	5	OH/UG	C.P.	#6-350	#6-2/0	4½	24½	16	2½	2	½
MAE	U8033-RL-KK	3	4	OH	H.O.	#6-350	#6-2/0	4½	32¼/16	16	2½	2	½
ALT, MAE	U8033-XL-KK	3	4	OH/UG	C.P.	#6-350	#6-2/0	4½	32¼/16	16	2½	2	½
MAE	U8034-RL-KK	4	4	OH	H.O.	#6-350	#6-2/0	4½	40⅞	16	2½	2	½
ALT, MAE	U8034-XL-KK	4	4	OH/UG	C.P.	#6-350	#6-2/0	4½	40⅞	16	2½	2	½
MAE	U8035-RL-KK	5	4	OH	H.O.	#6-350	#6-2/0	4½	49⅞/16	16	2½	2	½
ALT, MAE	U8035-XL-KK	5	4	OH/UG	C.P.	#6-350	#6-2/0	4½	49⅞/16	16	2½	2	½
MAE	U8036-RL-KK	6	4	OH	H.O.	#6-350	#6-2/0	4½	57¼	16	2½	2	½
ALT, MAE	U8036-XL-KK	6	4	OH/UG	C.P.	#6-350	#6-2/0	4½	57¼	16	2½	2	½

Notes

- **Hubs:** For proper hub selection, refer to the hub suffix chart on the accessories page.
- **Fifth Terminal:** For field-installable fifth terminal, order catalog number **5T8K2**. Installs in the 6 o'clock position only.
- **Connectors:** Extruded aluminum connectors are tin-plated.



Please consult serving utility for their requirements prior to ordering or installing, as specifications and approvals vary by utility, and may require local electrical inspector approval. All installations must be installed by a licensed electrician and must comply with all national and local codes, laws and regulations. Milbank reserves the right to make changes in specifications and features shown without notice or obligation.

Multi-Position Sockets

200 Amps | 4-5 Terminals | Ringless | 300V



U1252-X-KK-K1-ALT

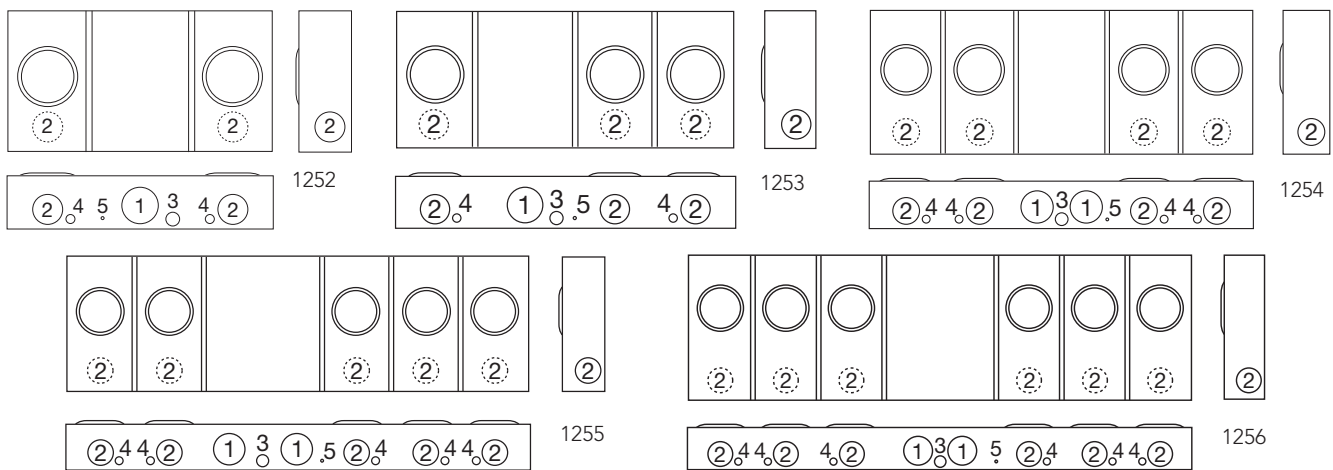

Alliant Approved | 200 Amps per Position | 4 Terminals | Ringless

Catalog Number	Positions	Service	Hub	Connectors CU/AL		Dimensions			Knockouts				
				Line	Load	D"	W"	H"	1	2	3	4	5
U1252-X-KK-K1-ALT	2	OH/UG	C.P.	#6-350	#6-350	5 1/8	26 1/2	14	3	2 1/2	1	1/2	1/4
U1253-X-KK-K1	3	OH/UG	C.P.	#6-350	#6-350	5 1/8	34 1/2	14	3	2 1/2	1	1/2	1/4
U1254-X-KK-K1	4	OH/UG	C.P.	#6-350	#6-350	5 1/8	42 1/16	16	3	2 1/2	1	1/2	1/4
U1255-X-KK-K1	5	OH/UG	C.P.	#6-350	#6-350	5 1/8	54 1/16	16	3	2 1/2	1	1/2	1/4
U1256-X-KK-K1	6	OH/UG	C.P.	#6-350	#6-350	5 1/8	62 7/8	18	3	2 1/2	1	1/2	1/4

Alliant Approved | 200 Amps per Position | 5 Terminals | Ringless

Catalog Number	Positions	Service	Hub	Connectors CU/AL		Dimensions			Knockouts				
				Line	Load	D"	W"	H"	1	2	3	4	5
U1252-X-KK-5T-K1	2	OH/UG	C.P.	#6-350	#6-350	5 1/8	26 1/2	14	3	2 1/2	1	1/2	1/4

Notes

- **Hubs:** For proper hub selection, refer to the hub suffix chart on the accessories page. For the **U1254-6** two hub openings are supplied and the extra opening is closed with a closing plate as standard.

Please consult serving utility for their requirements prior to ordering or installing, as specifications and approvals vary by utility, and may require local electrical inspector approval. All installations must be installed by a licensed electrician and must comply with all national and local codes, laws and regulations. Milbank reserves the right to make changes in specifications and features shown without notice or obligation.





U1254-X-KK

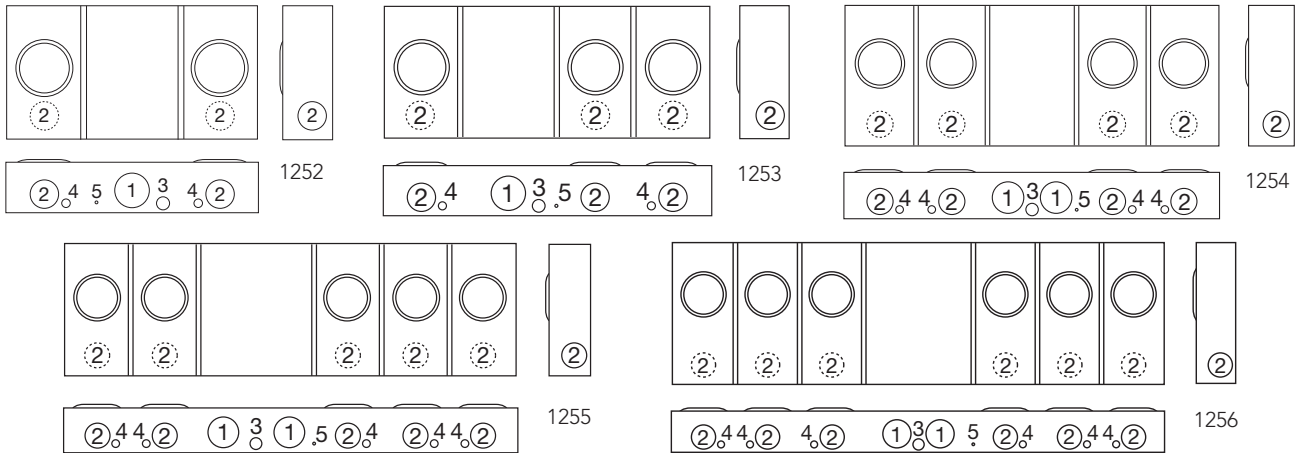

MidAmerican Approved | 200 Amps per Position | 4 Terminals | Ringless

Catalog Number	Positions	Service	Hub	Connectors CU/AL		Dimensions			Knockouts				
				Line	Load	D"	W"	H"	1	2	3	4	5
U1252-RRL-KK-K1	2	OH	H.O.	3/8" x 16 Studs	#6-350	5 1/8"	26 1/2"	14"	3"	2 1/2"	1"	1/2"	1/4"
U1252-X-KK-K1	2	OH/UG	C.P.	3/8" x 16 Studs	#6-350	5 1/8"	26 1/2"	14"	3"	2 1/2"	1"	1/2"	1/4"
U1253-RRL-KK-K1	3	OH	H.O.	3/8" x 16 Studs	#6-350	5 1/8"	34 1/2"	14"	3"	2 1/2"	1"	1/2"	1/4"
U1253-X-KK-K1	3	OH/UG	C.P.	3/8" x 16 Studs	#6-350	5 1/8"	34 1/2"	14"	3"	2 1/2"	1"	1/2"	1/4"
U1254-RRL-KK-K1	4	OH	H.O.	3/8" x 16 Studs	#6-350	5 1/8"	42 1 1/16"	16"	3"	2 1/2"	1"	1/2"	1/4"
U1254-X-KK-K1	4	OH/UG	C.P.	3/8" x 16 Studs	#6-350	5 1/8"	42 1 1/16"	16"	3"	2 1/2"	1"	1/2"	1/4"
U1255-RRL-KK-K1	5	OH	H.O.	3/8" x 16 Studs	#6-350	5 1/8"	54 1 1/16"	16"	3"	2 1/2"	1"	1/2"	1/4"
U1255-X-KK-K1	5	OH/UG	C.P.	3/8" x 16 Studs	#6-350	5 1/8"	54 1 1/16"	16"	3"	2 1/2"	1"	1/2"	1/4"
U1256-RRL-KK-K1	6	OH	H.O.	3/8" x 16 Studs	#6-350	5 1/8"	62 7/8"	18"	3"	2 1/2"	1"	1/2"	1/4"
U1256-X-KK-K1	6	OH/UG	C.P.	3/8" x 16 Studs	#6-350	5 1/8"	62 7/8"	18"	3"	2 1/2"	1"	1/2"	1/4"

Notes

- Hubs: For proper hub selection, refer to the hub suffix chart on the accessories page. For the U1254-6, two hub openings are supplied and the extra opening is closed with a closing plate as standard.
- Connectors: Extruded aluminum connectors are tin-plated. For line side connector lug kits, order as extra K1539 from chart on accessories page.



Please consult serving utility for their requirements prior to ordering or installing, as specifications and approvals vary by utility, and may require local electrical inspector approval. All installations must be installed by a licensed electrician and must comply with all national and local codes, laws and regulations. Milbank reserves the right to make changes in specifications and features shown without notice or obligation.

Lever Bypass Multi-Position Sockets

200 Amps | 5 Terminals | Ringless | 300V



U2872-Xt-5T9-K3

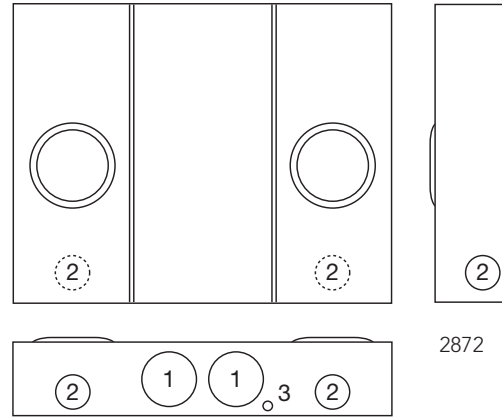

2872

Alliant Approved | 200 Amps per Position | 5 Terminals | Ringless

Catalog Number	Positions	Service	Hub	Connectors CU/AL		Bypass	Dimensions			Knockouts		
				Line	Load		D"	W"	H"	1	2	3
U2872-Xt-5T9-K3	2	OH/UG	(2) C.P.	#4-600 or (2) 1/0-250	#6-350	Lever	6	32 1/8	25 1/4	4	2 1/2	1/4, 1/2

Notes

- **Hubs:** Units supplied with two closing plates. To order additional hubs, refer to the hub suffix chart on the accessories page.
- **Bypass:** The lever operates bypass device and supplies clamping action to meter spades.

Please consult serving utility for their requirements prior to ordering or installing, as specifications and approvals vary by utility, and may require local electrical inspector approval. All installations must be installed by a licensed electrician and must comply with all national and local codes, laws and regulations. Milbank reserves the right to make changes in specifications and features shown without notice or obligation.



Lever Bypass Multi-Position Sockets

200 Amps | 5 Terminals | Ringless | 300V

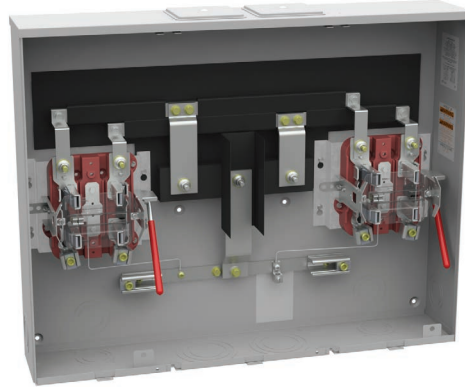

U2872-XT-5T9

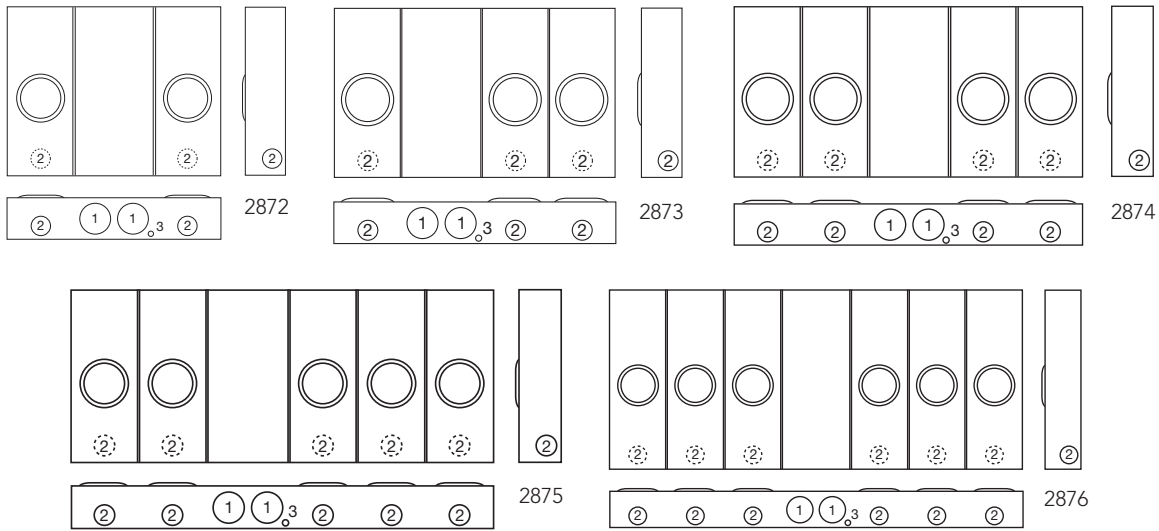

MidAmerican Approved | 200 Amps per Position | 5 Terminals | Ringless

Catalog Number	Positions	Service	Hub	Connectors CU/AL		Bypass	Dimensions			Knockouts		
				Line	Load		D"	W"	H"	1	2	3
U2872-XT-5T9	2	OH/UG	(2) C.P.	3/8" x 16 Studs	#6-350	Lever	6	32 1/8	25 1/4	4	2 1/2	1/4, 1/2
U2873-XT-5T9	3	OH/UG	(2) C.P.	3/8" x 16 Studs	#6-350	Lever	6	42 3/16	25 1/4	4	2 1/2	1/4, 1/2
U2874-XT-5T9	4	OH/UG	(2) C.P.	3/8" x 16 Studs	#6-350	Lever	6	52 1/4	25 1/4	4	2 1/2	1/4, 1/2
U2875-XT-5T9	5	OH/UG	(2) C.P.	3/8" x 16 Studs	#6-350	Lever	6	62 3/16	25 1/4	4	2 1/2	1/4, 1/2
U2876-XT-5T9	6	OH/UG	(2) C.P.	3/8" x 16 Studs	#6-350	Lever	6	72 3/8	31 1/4	4	2 1/2	1/4, 1/2

Notes

- **Hubs:** Units supplied with two closing plates. To order additional hubs, refer to the hub suffix chart on the accessories page.
- **Connector Kits:** For line side connector kits, order as extra **K1539** (350 kcmil), **K1540** (600 kcmil), **K1350** (twin 350 kcmil), **K1541** (twin 600 kcmil). Line connectors can be reversed to change from "OH" to "UG" service.
- **Bypass:** The lever operates bypass device and supplies clamping action to meter spades.



Please consult serving utility for their requirements prior to ordering or installing, as specifications and approvals vary by utility, and may require local electrical inspector approval. All installations must be installed by a licensed electrician and must comply with all national and local codes, laws and regulations. Milbank reserves the right to make changes in specifications and features shown without notice or obligation.

Lever Bypass Multi-Position Sockets

3 1

200 Amps | 7 Terminals | Ringless | 300V

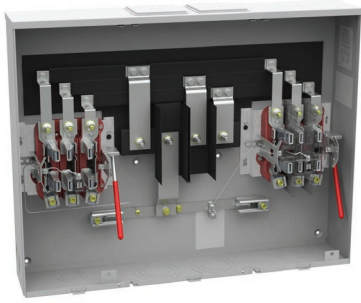

U2732-XT

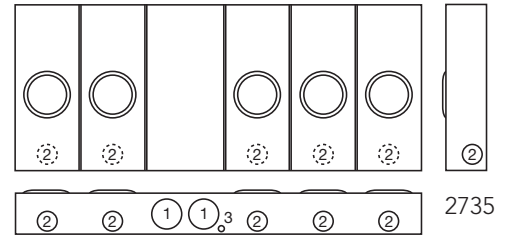
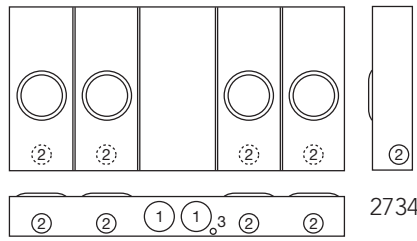
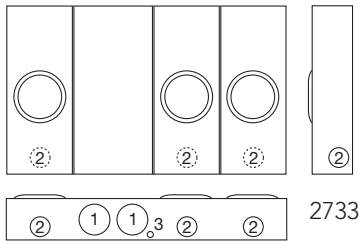
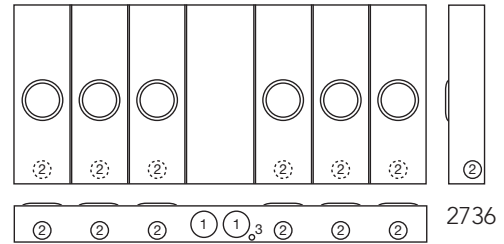
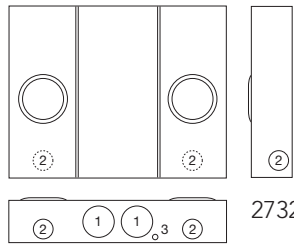

Alliant Approved | 200 Amps per Position | 7 Terminals | Ringless

Catalog Number	Positions	Service	Hub	Connectors CU/AL		Dimensions			Knockouts		
				Line	Load	D"	W"	H"	1	2	3
U2732-XT-K7	2	OH/UG	(2) C.P.	#4-600 or (2) 1/0-250	#6-350	6	32 ³ / ₈	25 ¹ / ₄	4	2 ¹ / ₂	1 ¹ / ₄ , 1 ¹ / ₂
U2733-XT-K7	3	OH/UG	(2) C.P.	#4-600 or (2) 1/0-250	#6-350	6	42 ³ / ₁₆	25 ¹ / ₄	4	2 ¹ / ₂	1 ¹ / ₄ , 1 ¹ / ₂
U2734-XT-K7	4	OH/UG	(2) C.P.	#4-600 or (2) 1/0-250	#6-350	6	52 ¹ / ₄	25 ¹ / ₄	4	2 ¹ / ₂	1 ¹ / ₄ , 1 ¹ / ₂
U2735-XT-K7	5	OH/UG	(2) C.P.	#4-600 or (2) 1/0-250	#6-350	6	62 ⁵ / ₁₆	25 ¹ / ₄	4	2 ¹ / ₂	1 ¹ / ₄ , 1 ¹ / ₂
U2736-XT-K7	6	OH/UG	(2) C.P.	#4-600 or (2) 1/0-250	#6-350	6	72 ³ / ₈	31 ¹ / ₄	4	2 ¹ / ₂	1 ¹ / ₄ , 1 ¹ / ₂

MidAmerican Approved | 200 Amps per Position | 7 Terminals | Ringless

Catalog Number	Positions	Service	Hub	Connectors CU/AL		Dimensions			Knockouts		
				Line	Load	D"	W"	H"	1	2	3
U2732-XT	2	OH/UG	(2) C.P.	3/8" x 16 Studs	#6-350	6	32 ³ / ₈	25 ¹ / ₄	4	2 ¹ / ₂	1 ¹ / ₄ , 1 ¹ / ₂
U2733-XT	3	OH/UG	(2) C.P.	3/8" x 16 Studs	#6-350	6	42 ³ / ₁₆	25 ¹ / ₄	4	2 ¹ / ₂	1 ¹ / ₄ , 1 ¹ / ₂
U2734-XT	4	OH/UG	(2) C.P.	3/8" x 16 Studs	#6-350	6	52 ¹ / ₄	25 ¹ / ₄	4	2 ¹ / ₂	1 ¹ / ₄ , 1 ¹ / ₂
U2735-XT	5	OH/UG	(2) C.P.	3/8" x 16 Studs	#6-350	6	62 ⁵ / ₁₆	25 ¹ / ₄	4	2 ¹ / ₂	1 ¹ / ₄ , 1 ¹ / ₂
U2736-XT	6	OH/UG	(2) C.P.	3/8" x 16 Studs	#6-350	6	72 ³ / ₈	31 ¹ / ₄	4	2 ¹ / ₂	1 ¹ / ₄ , 1 ¹ / ₂

Notes

- **Hubs:** Units supplied with two closing plates. To order additional hubs, refer to the hub suffix chart on the accessories page.
- **Bypass:** The lever operates bypass device and supplies clamping action to meter spades.

Please consult serving utility for their requirements prior to ordering or installing, as specifications and approvals vary by utility, and may require local electrical inspector approval. All installations must be installed by a licensed electrician and must comply with all national and local codes, laws and regulations. Milbank reserves the right to make changes in specifications and features shown without notice or obligation.



Multi-Position Meter Mains

125-200 Amps | 4 Terminals | Ringless | 240V



U5884-X-KK-K1-ALT

Alliant Approved | 125 Amps per Position | 4 Terminals | Ringless

Catalog Number	Positions	Service	Hub	Connectors CU/AL Line	Bypass	Dimensions			Weight (lbs.)
						D"	W"	H"	
U5902-X-KK-K1	2	OH/UG	C.P.	#6-350	Horn	5 $\frac{1}{8}$	26 $\frac{1}{2}$	30	58
U5903-X-KK-K1	3	OH/UG	C.P.	#6-350	Horn	5 $\frac{1}{8}$	34 $\frac{5}{8}$	30	88
U5904-X-KK-K1	4	OH/UG	C.P.	#6-350	Horn	5 $\frac{1}{8}$	42 $\frac{4}{5}$	30	107
U5905-X-KK-K1	5	OH/UG	C.P.	#6-350	Horn	5 $\frac{1}{8}$	51 $\frac{1}{20}$	30	128
U5906-X-KK-K1	6	OH/UG	C.P.	#6-350	Horn	5 $\frac{1}{8}$	59 $\frac{3}{10}$	30	146

Alliant Approved | 200 Amps per Position | 4 Terminals | Ringless

Catalog Number	Positions	Service	Hub	Connectors CU/AL Line	Bypass	Dimensions			Weight (lbs.)
						D"	W"	H"	
U5882-X-KK-K1-ALT	2	OH/UG	C.P.	#6-350	Horn	5 $\frac{1}{8}$	26 $\frac{1}{2}$	30	58
U5883-X-KK-K1-ALT	3	OH/UG	C.P.	#6-350	Horn	5 $\frac{1}{8}$	34 $\frac{5}{8}$	30	88
U5884-X-KK-K1-ALT	4	OH/UG	C.P.	#6-350	Horn	5 $\frac{1}{8}$	42 $\frac{4}{5}$	30	107
U5885-X-KK-K2-ALT	5	OH/UG	C.P.	#6-350	Horn	5 $\frac{1}{8}$	51 $\frac{1}{20}$	30	128
U5886-X-KK-K2-ALT	6	OH/UG	C.P.	#6-350	Horn	5 $\frac{1}{8}$	59 $\frac{3}{10}$	30	146

Notes

- **NEC 2020 Compliant:** All products are NEC 2020 Compliant.
- **Knockouts:** See page 36 for drawings and knockout configurations.
- **Breakers:** Factory-installed breakers are available — consult factory.
- **AIC Rating:** All models are rated 22K AIC. However, this rating is limited to the lowest interrupting capacity of any circuit breaker installed. Watthour meter not included in short circuit current rating.
- **Hub:** Units supplied with one closing plate. To order hubs separately, see accessories page.

Breaker Chart - 10K AIC (unless noted 22K)

Manufacturer	Cutler-Hammer	Siemens	GE (50 Amps Max)	Square D
125 Amps or Less	BR, HQP, QPGF	QP, QPH (22K)	THQL, THQL-GF	Homeline
150-200 Amps	BR, BJ	QN, QNH (22K)	—	—



Please consult serving utility for their requirements prior to ordering or installing, as specifications and approvals vary by utility, and may require local electrical inspector approval. All installations must be installed by a licensed electrician and must comply with all national and local codes, laws and regulations. Milbank reserves the right to make changes in specifications and features shown without notice or obligation.

Multi-Position Meter Mains

125-200 Amps | 4 Terminals | Ringless | 240V



U5884-X-KK-K1

MidAmerican Approved | 125 Amps per Position | 4 Terminals | Ringless

Catalog Number	Positions	Service	Hub	Connectors CU/AL		Bypass	Dimensions			Weight (lbs.)
				Line			D"	W"	H"	
U5902-X-KK	2	OH/UG	C.P.	3/8"	x 16 Studs	Horn	5 1/8"	26 1/2"	30"	58
U5903-X-KK	3	OH/UG	C.P.	3/8"	x 16 Studs	Horn	5 1/8"	34 3/8"	30"	88
U5904-X-KK	4	OH/UG	C.P.	3/8"	x 16 Studs	Horn	5 1/8"	42 2/5"	30"	107
U5905-X-KK	5	OH/UG	C.P.	3/8"	x 16 Studs	Horn	5 1/8"	51 1/20"	30"	128
U5906-X-KK	6	OH/UG	C.P.	3/8"	x 16 Studs	Horn	5 1/8"	59 3/10"	30"	146

MidAmerican Approved | 200 Amps per Position | 4 Terminals | Ringless

Catalog Number	Positions	Service	Hub	Connectors CU/AL		Bypass	Dimensions			Weight (lbs.)
				Line			D"	W"	H"	
U5882-X-KK-K1	2	OH/UG	C.P.	#6-350		Horn	5 1/8"	26 1/2"	30"	58
U5883-X-KK-K1	3	OH/UG	C.P.	#6-350		Horn	5 1/8"	34 3/8"	30"	88
U5884-X-KK-K1	4	OH/UG	C.P.	#6-350		Horn	5 1/8"	42 2/5"	30"	107
U5885-X-KK-K1	5	OH/UG	C.P.	#6-350		Horn	5 1/8"	51 1/20"	30"	128
U5886-X-KK-K1	6	OH/UG	C.P.	#6-350		Horn	5 1/8"	59 3/10"	30"	146

Notes

- **NEC 2020 Compliant:** All products are NEC 2020 Compliant.
- **Knockouts:** See the next page for drawings and knockout configurations.
- **Breakers:** Factory-installed breakers are available — consult factory.
- **AIC Rating:** All models are rated 22K AIC. However, this rating is limited to the lowest interrupting capacity of any circuit breaker installed. Watthour meter not included in short circuit current rating.
- **Hub:** Units supplied with one closing plate. To order hubs separately, see the accessories page.
- **Lugs:** For line side connector lug kits, order as extra **K1539** from chart on the accessories page.

Breaker Chart - 10K AIC (unless noted 22K)

Manufacturer	Cutler-Hammer	Siemens	GE (50 Amps Max)	Square D
125 Amps or Less	BR, HQP, QPGF	QP, QPH (22K)	THQL, THQL-GF	Homeline
150-200 Amp	BR, BJ	QN, QNH (22K)	—	—

Please consult serving utility for their requirements prior to ordering or installing, as specifications and approvals vary by utility, and may require local electrical inspector approval. All installations must be installed by a licensed electrician and must comply with all national and local codes, laws and regulations. Milbank reserves the right to make changes in specifications and features shown without notice or obligation.



Knockouts				
1	2	3	4	5
3	2½	1	¾	¼

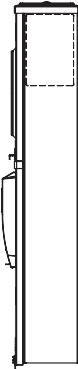
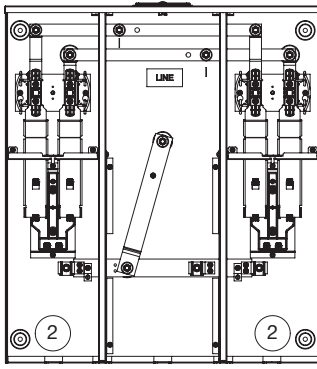

5882

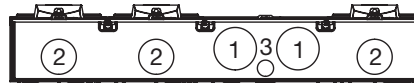
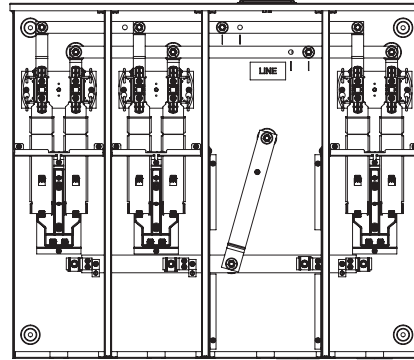

5883

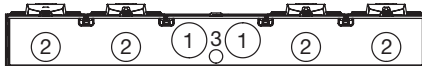
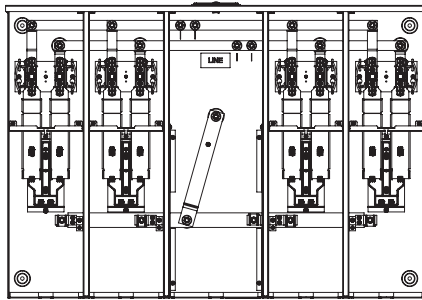

5884

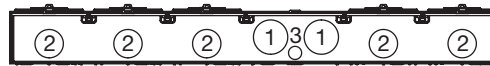
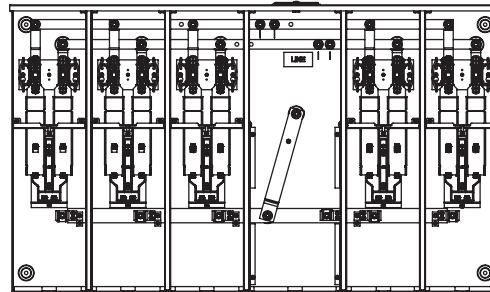

5885

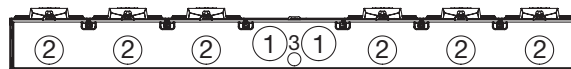
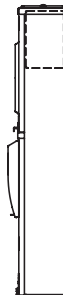
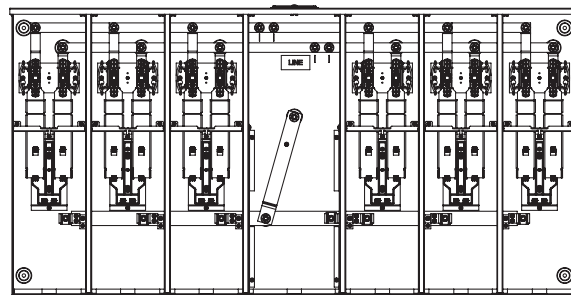

5886



Please consult serving utility for their requirements prior to ordering or installing, as specifications and approvals vary by utility, and may require local electrical inspector approval. All installations must be installed by a licensed electrician and must comply with all national and local codes, laws and regulations. Milbank reserves the right to make changes in specifications and features shown without notice or obligation.

Lever Bypass Multi-Position Sockets

35

200 Amps per Position | 5 Terminals | Ringless | 120/240V



U5974-Xt-5T9

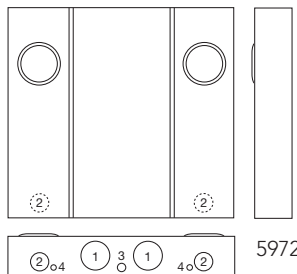

5972

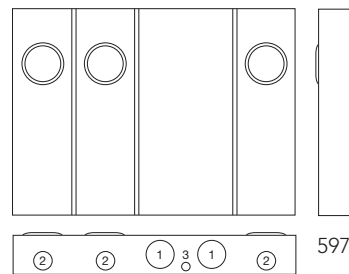

5973

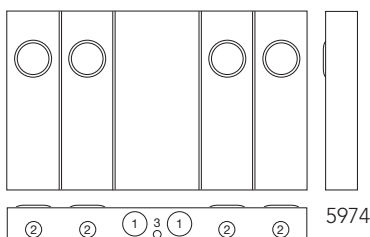

5974

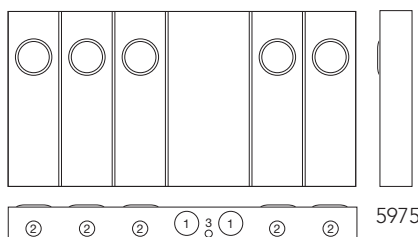

5975

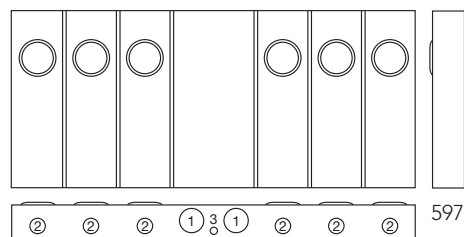

5976

Alliant Approved | 200 Amps per Position | 5 Terminals | Ringless

Catalog Number	Positions	Main Bus Rating	Line Connector Size	Dimensions			Knockouts			
				D"	W"	H"	1	2	3	4
U5972-Xt-5T9	2	320 Amps	3/8" x 16 Studs*	6	36 3/8	34	4	2 1/2	1	1/2
U5973-Xt-5T9	3	480 Amps	3/8" x 16 Studs*	6	46 1/2	34	4	2 1/2	1	—
U5974-Xt-5T9	4	640 Amps	3/8" x 16 Studs*	6	57	34	4	2 1/2	1	—
U5975-Xt-5T9	5	640 Amps	3/8" x 16 Studs*	6	67 1/8	34	4	2 1/2	1	—
U5976-Xt-5T9	6	640 Amps	3/8" x 16 Studs*	6	77 1/16	34	4	2 1/2	1	—

Connector Kits*

Size	Suffix	Kit Number	Wire Range
Single	-K1	K1539	#6-350
	-K3	K1540	#4-600
Twin	-K2	K1350	#6-350
	-K4	K1541	#2-600

Breaker Chart

Manufacturer	125-200 Amps	125 Amps or Less
Cutler-Hammer	BR, BJ, QN	Quicklag P, BR, HQP
Siemens (ITE)	QN	QP
Siemens (Murray/Crouse Hinds)	MD	MP
GE	Q Line	Q Line
Square D	—	Homeline

Notes

- **NEC 2020 Compliant:** All products are NEC 2020 Compliant.
- **Breakers:** Units have provision for one two-pole main per meter position. Breakers not included. Order as extra (see chart above).
- **Bypass:** The lever operates bypass device and supplies clamping action to meter spades.
- **Short Circuit Current Rating:** 22K AIC. However, this rating is limited to the lowest interrupting capacity of any circuit breaker installed. Watthour meter not included in short circuit current rating.

*For line wire connector kits, order separately (see chart above).

Please consult serving utility for their requirements prior to ordering or installing, as specifications and approvals vary by utility, and may require local electrical inspector approval. All installations must be installed by a licensed electrician and must comply with all national and local codes, laws and regulations. Milbank reserves the right to make changes in specifications and features shown without notice or obligation.





UC7478-XL

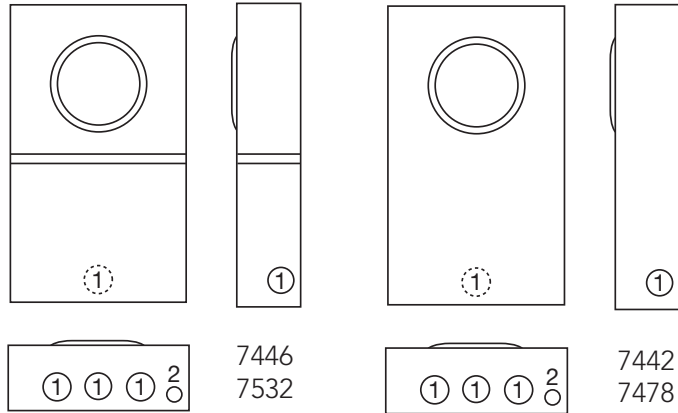

Alliant Approved | with Factory Wired Test Switch | Ringless

Catalog Number	Terminals	Service	Hub	Meter Form	Cover	Connectors CU	Bypass	Dimensions			Knockouts	
								D"	W"	H"	1	2
UC7446-XL-121-ALT	5	OH/UG	C.P.	3S	2 Piece	#14 - #4 Max	None	4 $\frac{1}{8}$	12	20	1 $\frac{1}{4}$	$\frac{1}{4}$, $\frac{1}{2}$
UC7532-XL-401-ALT	6	OH/UG	C.P.	4S	2 Piece	#14 - #4 Max	None	4 $\frac{1}{8}$	12	20	1 $\frac{1}{4}$	$\frac{1}{4}$, $\frac{1}{2}$

MidAmerican Approved | with Test Switch Provision* | Ringless

Catalog Number	Terminals	Service	Hub	Meter Form	Cover	Connectors CU	Bypass	Dimensions			Knockouts	
								D"	W"	H"	1	2
UC7442-O	5	UG	Blank	3S	1 Piece	#14 - #4 Max	None	4 $\frac{1}{8}$	12	20	1 $\frac{1}{4}$	$\frac{1}{4}$, $\frac{1}{2}$
UC7442-RL	5	OH	H.O.	3S	1 Piece	#14 - #4 Max	None	4 $\frac{1}{8}$	12	20	1 $\frac{1}{4}$	$\frac{1}{4}$, $\frac{1}{2}$
UC7478-O	6	UG	Blank	4S	1 Piece	#14 - #4 Max	None	4 $\frac{1}{8}$	12	20	1 $\frac{1}{4}$	$\frac{1}{4}$, $\frac{1}{2}$
UC7478-RL	6	OH	H.O.	4S	1 Piece	#14 - #4 Max	None	4 $\frac{1}{8}$	12	20	1 $\frac{1}{4}$	$\frac{1}{4}$, $\frac{1}{2}$
UC7478-XL	6	OH/UG	C.P.	4S	1 Piece	#14 - #4 Max	None	4 $\frac{1}{8}$	12	20	1 $\frac{1}{4}$	$\frac{1}{4}$, $\frac{1}{2}$

Notes

- **Hubs:** For proper hub selection, see the hub suffix chart on the accessories page.
 - **Bypass:** Plunger type bypass automatically closes when meter is removed.
- *Units on this page are not designed for use with test switch covers



Please consult serving utility for their requirements prior to ordering or installing, as specifications and approvals vary by utility, and may require local electrical inspector approval. All installations must be installed by a licensed electrician and must comply with all national and local codes, laws and regulations. Milbank reserves the right to make changes in specifications and features shown without notice or obligation.

Transformer Rated

37

20 Amps | 8 Terminals | Ringless | 600V



UC7448-RL

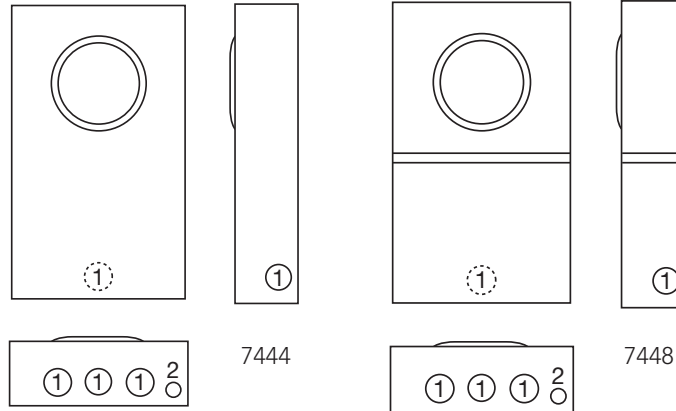

Alliant Approved | with Factory Wired Test Switch or Test Switch Provision* | Ringless

Catalog Number	Terminals	Service	Hub	Meter Form	Cover	Connectors CU	Bypass	Dimensions			Knockouts	
								D"	W"	H"	1	2
UC7448-XL-341†	8	OH/UG	C.P.	5S	2 Piece	#14 - #4 Max	None	4½	12	20	1¼	¼, ½
UC7448-RL-351†	8	OH/UG	H.O.	5S	2 Piece	#14 - #4 Max	None	4½	12	20	1¼	¼, ½

MidAmerican Approved | with Test Switch Provision* | Ringless

Catalog Number	Terminals	Service	Hub	Meter Form	Cover	Connectors CU	Bypass	Dimensions			Knockouts	
								D"	W"	H"	1	2
UC7444-RL	8	OH	H.O.	5S	1 Piece	#14 - #4 Max	None	4½	12	20	1¼	¼, ½
UC7444-XL	8	OH/UG	C.P.	5S	1 Piece	#14 - #4 Max	None	4½	12	20	1¼	¼, ½

Notes

- **Hubs:** For proper hub selection, see the hub suffix chart on the accessories page.
- **Prewiring:** If standard factory prewiring is required, refer to wiring diagrams in the general engineering section of this catalog. Determine appropriate diagram and send copy with order. If custom factory prewiring is required, specify on order. Be sure to include meter socket catalog number, test switch model and number, and meter form number. Please be sure to provide a copy of your wiring diagram.

*Units on this page are not designed for use with test switch covers.

†These products include factory wired test switch.

Please consult serving utility for their requirements prior to ordering or installing, as specifications and approvals vary by utility, and may require local electrical inspector approval. All installations must be installed by a licensed electrician and must comply with all national and local codes, laws and regulations. Milbank reserves the right to make changes in specifications and features shown without notice or obligation.



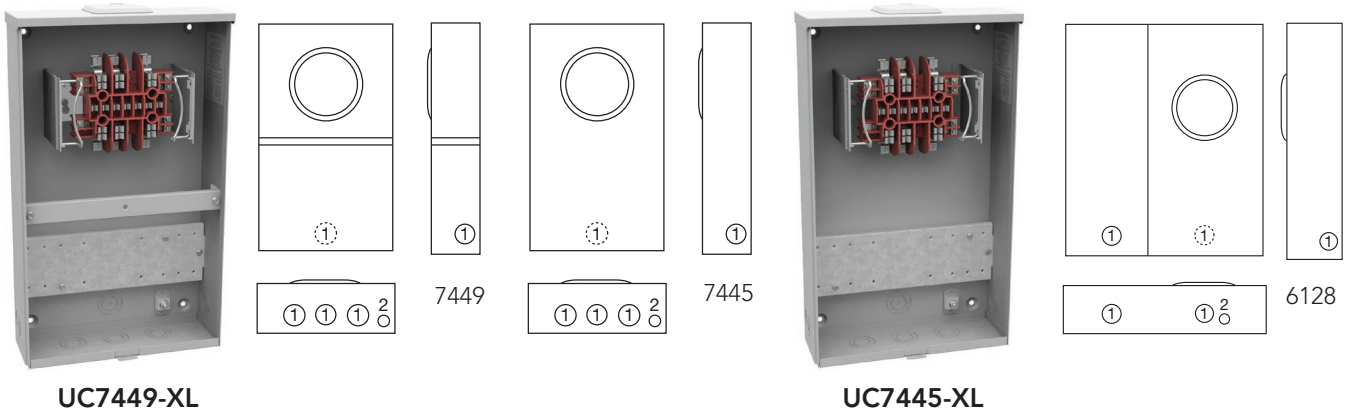

Alliant Approved | with Factory Wired Test Switch or Test Switch Provision* | Ringless

Catalog Number	Terminals	Service	Hub	Meter Form	Cover	Connectors CU	Dimensions			Knockouts	
							D"	W"	H"	1	2
UC7449-XL-871-ALT	13	OH/UG	C.P.	6, 8, 9 and (ALT) 10	2 Piece	#14 - #4 Max	4 $\frac{1}{8}$	12	20	1 $\frac{1}{4}$	$\frac{1}{4}$, $\frac{1}{2}$

MidAmerican Approved | with Test Switch or Test Switch Provision* | Ringless

Catalog Number	Terminals	Service	Hub	Meter Form	Cover	Connectors CU	Dimensions			Knockouts	
							D"	W"	H"	1	2
UC7445-RL	13	OH	H.O.	6, 8, 9 and (ALT) 10	1 Piece	#14 - #4 Max	4 $\frac{1}{8}$	12	20	1 $\frac{1}{4}$	$\frac{1}{4}$, $\frac{1}{2}$
UC7445-XL	13	OH/UG	C.P.	6, 8, 9 and (ALT) 10	1 Piece	#14 - #4 Max	4 $\frac{1}{8}$	12	20	1 $\frac{1}{4}$	$\frac{1}{4}$, $\frac{1}{2}$
UC7445-XL-TS100109*	13	OH/UG	C.P.	6, 8, 9 and (ALT) 10	1 Piece	#14 - #4 Max	4 $\frac{1}{8}$	12	20	1 $\frac{1}{4}$	$\frac{1}{4}$, $\frac{1}{2}$
UC7445-O	13	UG	Blank	6, 8, 9 and (ALT) 10	1 Piece	#14 - #4 Max	4 $\frac{1}{8}$	12	20	1 $\frac{1}{4}$	$\frac{1}{4}$, $\frac{1}{2}$
SC6128-XL-TS100109**	13	OH/UG	C.P.	6, 8, 9 and (ALT) 10	2 Piece	#14 - #4 Max	4 $\frac{3}{4}$	20	22	1 $\frac{1}{4}$	$\frac{1}{4}$, $\frac{1}{2}$

Notes

- **Hubs:** For proper hub selection, see the hub suffix chart on the accessories page.
- **Prewiring:** If standard factory prewiring is required, refer to wiring diagrams in the general engineering section of this catalog. Determine appropriate diagram and send copy with order. If custom factory prewiring is required, specify on order. Be sure to include meter socket catalog number, test switch model and number, and meter form number. Please be sure to provide a copy of your wiring diagram.

*Test switch included. See next page for test switch details.

** SC6128-XL-TS100109 is approved by Mid-American for 277/480 volts.



Please consult serving utility for their requirements prior to ordering or installing, as specifications and approvals vary by utility, and may require local electrical inspector approval. All installations must be installed by a licensed electrician and must comply with all national and local codes, laws and regulations. Milbank reserves the right to make changes in specifications and features shown without notice or obligation.

Test Switches

4, 7 and 10 Pole

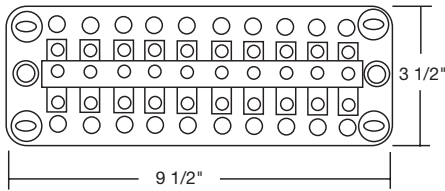
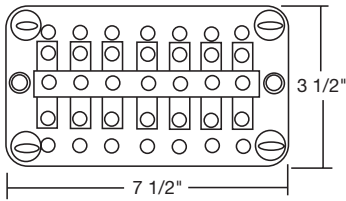
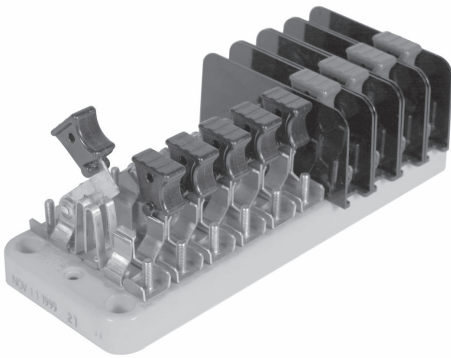

Key	
P	Potential switch
C+	Line side current switch with short circuit assembly
C	Load side current switch with test jack assembly
N	Neutral bar (no switch)
Pn	Neutral potential switch
X	Unused position on base
	Insulating barrier, isolates both sides of switch

Catalog Number	4-Pole						
TS04-0101	X	P		X	C+	C	X
TS04-0102	X		C+	C	X	Pn	X
TS04-0103	X	P		X	C	C+	X
TS04-0104	X	C+	C	X	P		X

Notes

- 4-pole switches are also available on 10-pole bases. Contact Milbank for appropriate catalog numbers.

Catalog Number	7-Pole						
TS07-0105		P		C+	C	C+	C
TS07-0106		C+	C		C+	C	
TS07-0107		P		C	C+	C	C+
TS07-0108	C+	C	C+	C		P	

Catalog Number	7-Pole on a 10-Pole Base									
TS07-0049		X		X		X	C+	C	C	C+
TS07-0018		X		X		X	C+	C	C+	C
TS07-0059	X		C+	C		C	C+		X	X
TS07-0022	P	X	P	X	Pn	X	C	C+	C	C+

Catalog Number	10-Pole									
TS10-0109	P		P		C+	C	C+	C	C+	C
TS10-0110		C+	C		C+	C		C+	C	
TS10-0111	P		P		C	C+	C	C+	C	C+
TS10-0112	C+	C	C+	C	C+	C		P		

Please consult serving utility for their requirements prior to ordering or installing, as specifications and approvals vary by utility, and may require local electrical inspector approval. All installations must be installed by a licensed electrician and must comply with all national and local codes, laws and regulations. Milbank reserves the right to make changes in specifications and features shown without notice or obligation.



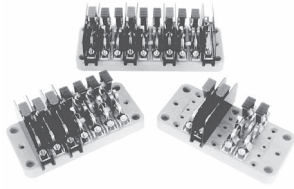

Customer Name: _____

Address: _____

Phone / Fax #: _____

Handle Color Key							
BK	Black	P	Purple	Y	Yellow	GN	Green
R	Red	BL	Blue	W	White	BKS	Black Stripe
BR	Brown	GR	Gray	O	Orange	WS	White Stripe

TEST SWITCH BASE

The base is molded from a high strength, fiberglass reinforced, thermoset polyester. This material is track-resistant, flame-resistant and has low water absorption qualities. Bases are available in two standard sizes following NEMA mounting classifications.

Pole Position Chart

1	2	3	4	5	6	7	8	9	10

Special Features

Feature	1	2	3	4	5	6	7	8	9	10
45° Angle Stops										
Ganged Handles (C)										
Bussing										
Colored Handles										

Engineering Information: _____

Key	
P	Potential switch
C+	Line-side current switch with short circuit assembly
C	Load side current switch with test jack assembly
N	Neutral bar (no switch)
Pn	Neutral potential switch
X	Unused position on base
L	Insulating barrier - one side
□	Insulating barrier - two sides

Custom Pole Arrangements: The key may be used to diagram your own pole arrangement. Be sure to specify base size and whether all C+ line-side, current switch/shunt circuit assemblies are to be bussed together.

Number of Poles

- 4
- 7
- 10
- Other _____

Test Switch Cover (only available for 10-pole bases)

- Yes | Clear ___ Black ___
- No

Base Size

- 7-Pole
- 10-Pole



Please consult serving utility for their requirements prior to ordering or installing, as specifications and approvals vary by utility, and may require local electrical inspector approval. All installations must be installed by a licensed electrician and must comply with all national and local codes, laws and regulations. Milbank reserves the right to make changes in specifications and features shown without notice or obligation.

Outdoor Transformer Cabinets

NEMA 3R | MidAmerican Approved



S9690-O

NEMA 3R

Catalog Number	Dimensions			Gauge of Steel	Board Size	
	D"	W"	H"		W"	H"
S9690-O	13	24	24	16	22	18
S9691-O*	13	30	30	14	28	24
S9692-O*	13	36	36	16	34	30

Features

Supplied with solid back board, three-point locking handle, lift-off hinges with stainless steel pins and padlock provisions.

UL-Listed | Continuous Hinge | NEMA 3R

Catalog Number	Dimensions			Gauge of Steel	Panel Size		Panel and Backboard Catalog Numbers	
	D"	W"	H"		W"	H"	Painted Steel Panel	Wood Backboard
363010-CT3R*	10	36	30	14	33	27	A-36P30	A-36P30W
363016-CT3R*	16	36	30	14	33	27	A-36P30	A-36P30W
363610-CT3R*	10	36	36	14	33	33	A-36P36	A-36P36W
363612-CT3R*	12	36	36	14	33	33	A-36P36	A-36P36W
363616-CT3R*	16	36	36	14	33	33	A-36P36	A-36P36W
483616-CT3R*	16	48	36	14	33	45	A-48P36	A-48P36W
484812-CT3R*	12	48	48	14	45	45	A-48P48	A-48P48W
606013-CT3R*	13	60	60	12	57	57	A-60P60	A-60P60W

Notes

- **Features:** Supplied with studs, three-point locking handle, continuous hinge and padlock provision. Single door provided on units less than 36 inches wide. Steel panels and plywood backboard are optional. For additional metal backboards, add the appropriate suffix to the end of the catalog number: **A** for aluminum, **S** for 304 stainless steel or **Z** for 316 stainless steel.
- **CT Mounting Rack:** For wall- or pole-mount CT rack, order **S7860**. This unit accommodates three donut style CTs.

*Indicates double door units

Please consult serving utility for their requirements prior to ordering or installing, as specifications and approvals vary by utility, and may require local electrical inspector approval. All installations must be installed by a licensed electrician and must comply with all national and local codes, laws and regulations. Milbank reserves the right to make changes in specifications and features shown without notice or obligation.





ALIM-413

Underground Entry and Overhead Exit

Catalog Number	Amps	Voltage	Phase	SCCR	Dimensions			Cabinet Drawing	Bus Drawing
					H"	W"	D"		
ALIM-413	400	250	1Ø3W	65kA	48	25	15	20104-03	20104-805
ALIM-434	400	250	3Ø4W	65kA	48	25	15	20104-03	20104-805
ALIM-613	600	250	1Ø3W	65kA	48	25	15	20104-03	20104-815
ALIM-634	600	250	3Ø4W	65kA	48	25	15	20104-03	20104-815
ALIM-813	800	250	1Ø3W	65kA	48	25	15	20104-03	20104-825
ALIM-834	800	250	3Ø4W	65kA	48	25	15	20104-03	20104-825
ALIM-1234	1200	250	3Ø4W	85kA	54	36	15	20104-07	20104-835

600V, 3Ø-4W Units with Provisions for Mounting Three Potential Transformers

Catalog Number	Amps	Voltage	Phase	SCCR	Dimensions			Cabinet Drawing	Bus Drawing
					H"	W"	D"		
ALIM-464	400	600	3Ø4W	65kA	48	36	15	20104-05	20104-807
ALIM-664	600	600	3Ø4W	65kA	48	36	15	20104-05	20104-817
ALIM-864	800	600	3Ø4W	65kA	48	36	15	20104-05	20104-826
ALIM-1264	1200	600	3Ø4W	85kA	54	46	15	20104-08	20104-836

Notes

- Line side lugs are 1000 MCM-500 MCM starting at 1600 Amps.



Please consult serving utility for their requirements prior to ordering or installing, as specifications and approvals vary by utility, and may require local electrical inspector approval. All installations must be installed by a licensed electrician and must comply with all national and local codes, laws and regulations. Milbank reserves the right to make changes in specifications and features shown without notice or obligation.

Current Transformer Cabinets

Alliant Area Units | UL-Listed



ALIM-1234UGBX

Underground Entry and Underground Exit

Catalog Number	Amps	Voltage	Phase	Wireway Size	SCCR	Dimensions			Cabinet Drawing	Bus Drawing
						H"	W"	D"		
ALIM-413UGBX	400	250	1Ø3W	4 X 5	65kA	48	25	15	20104-03	20104-766A
ALIM-434UGBX	400	250	3Ø4W	4 X 5	65kA	48	25	15	20104-03	20104-766A
ALIM-613UGBX	600	250	1Ø4W	4 X 8	65kA	48	36	15	20104-05	20104-767
ALIM-634UGBX	600	250	3Ø4W	4 X 8	65kA	48	36	15	20104-05	20104-767
ALIM-813UGBX	800	250	1Ø4W	4 X 8	65kA	48	36	15	20104-05	20104-768
ALIM-834UGBX	800	250	3Ø4W	4 X 8	65kA	48	36	15	20104-05	20104-768
ALIM-1234UGBX	1200	250	3Ø4W	8 X 8	85kA	54	46	15	20104-08	20104-769

600 Volt, 3Ø-4W Units with Provisions for Mounting Three Potential Transformers

Catalog Number	Amps	Voltage	Phase	Wireway Size	SCCR	Dimensions			Cabinet Drawing	Bus Drawing
						H"	W"	D"		
ALIM-464UGBX	400	600	3Ø4W	4 X 8	65kA	48	36	15	20104-05	20104-774
ALIM-664UGBX	600	600	3Ø4W	4 X 8	65kA	48	36	15	20104-05	20104-775
ALIM-864UGBX	800	600	3Ø4W	4 X 8	65kA	48	36	15	20104-05	20104-776
ALIM-1264UGBX	1200	600	3Ø4W	8 X 8	85kA	48	54	15	20104-10	20104-777

Notes

- Line side lugs are 1000 MCM-500 MCM starting at 1600 Amps.

Please consult serving utility for their requirements prior to ordering or installing, as specifications and approvals vary by utility, and may require local electrical inspector approval. All installations must be installed by a licensed electrician and must comply with all national and local codes, laws and regulations. Milbank reserves the right to make changes in specifications and features shown without notice or obligation.



Pad-mount

Catalog Number	Amps	Voltage	Phase	Wireway Size	SCCR	Dimensions			Cabinet Drawing	Bus Drawing
						H"	W"	D"		
ALIM-413PM	400	250	1Ø3W	4 X 5	65kA	58	25	15	20104-03PM	20104-766A
ALIM-434PM	400	250	3Ø4W	4 X 5	65kA	58	25	15	20104-03PM	20104-766A
ALIM-613PM	600	250	1Ø3W	4 X 8	65kA	58	36	15	20104-05PM	20104-767
ALIM-634PM	600	250	3Ø4W	4 X 8	65kA	58	36	15	20104-05PM	20104-767
ALIM-813PM	800	250	1Ø3W	4 X 8	65kA	58	36	15	20104-05PM	20104-768
ALIM-834PM	800	250	3Ø4W	4 X 8	65kA	58	36	15	20104-05PM	20104-768
ALIM-1234PM	1200	250	3Ø4W	8 X 8	85kA	64	46	15	20104-08PM	20104-769
ALIM-1634PM	1600	250	3Ø4W	8 X 10	85kA	66	54	15	20104-12PM	20104-770
ALIM-2034PM	2000	250	3Ø4W	8 X 10	85kA	66	54	15	20104-12PM	20104-771
ALIM-2534PM	2500	250	3Ø4W	8 X 16	85kA	72	50	21	20104-14PM	20104-772
ALIM-3034PM	3000	250	3Ø4W	8 X 16	85kA	72	50	21	20104-14PM	20104-773

Notes

- The pad-mount units are a "UGBX" model with a 10-inch high base section added.
- Stoughton, WI - Stoughton Utilities has approved all Alliant Energy units for use on their system.
- Line side lugs are 1000 MCM-500 MCM starting at 1600 Amps.



Please consult serving utility for their requirements prior to ordering or installing, as specifications and approvals vary by utility, and may require local electrical inspector approval. All installations must be installed by a licensed electrician and must comply with all national and local codes, laws and regulations. Milbank reserves the right to make changes in specifications and features shown without notice or obligation.

Current Transformer Cabinets

Alliant Area Units | UL-Listed



ALIM-3064PM

600V, 3Ø-4W Units with Provisions for Mounting Three Potential Transformers

Catalog Number	Amps	Voltage	Phase	Wireway Size	SCCR	Dimensions			Cabinet Drawing	Bus Drawing
						H"	W"	D"		
ALIM-464PM	400	600	3Ø4W	4 X 8	65kA	58	36	15	20104-05PM	20104-774
ALIM-664PM	600	600	3Ø4W	4 X 8	65kA	58	36	15	20104-05PM	20104-775
ALIM-864PM	800	600	3Ø4W	4 X 8	65kA	58	36	15	20104-05PM	20104-776
ALIM-1264PM	1200	600	3Ø4W	8 X 8	85kA	58	54	15	20104-10PM	20104-777
ALIM-1664PM	1600	600	3Ø4W	8 X 10	85kA	66	60	15	20104-17PM	20104-778
ALIM-2064PM	2000	600	3Ø4W	8 X 10	85kA	66	60	15	20104-17PM	20104-779
ALIM-2564PM	2500	600	3Ø4W	8 X 16	85kA	72	60	21	20104-15PM	20104-780
ALIM-3064PM	3000	600	3Ø4W	8 X 16	85kA	72	60	21	20104-15PM	20104-781

Top Entrance and Bottom Exit | Bottom Entrance and Top Exit

Catalog Number	Amps	Voltage	Phase	SCCR	Dimensions		
					H"	W"	D"
ALIRESM-413	400	250	1Ø3W	65kA	42	20	8
ALIRESM-434	400	250	3Ø4W	65kA	42	20	8
ALIRESM-613	600	250	1Ø4W	65kA	42	24	8
ALIRESM-634	600	250	3Ø4W	85kA	42	24	8

Notes

- The pad-mount units are a "UGBX" model with a 10-inch high base section added.
- Stoughton, WI - Stoughton Utilities has approved all Alliant Energy units for use on their system.
- Line side lugs are 1000 MCM-500 MCM starting at 1600 Amps.

Please consult serving utility for their requirements prior to ordering or installing, as specifications and approvals vary by utility, and may require local electrical inspector approval. All installations must be installed by a licensed electrician and must comply with all national and local codes, laws and regulations. Milbank reserves the right to make changes in specifications and features shown without notice or obligation.



Underground or Overhead Entry

Catalog Number	Amps	Voltage	Phase	SCCR	Lugs (size) per Phase	Dimensions			Cabinet Drawing	Bus Drawing
						H"	W"	D"		
TBALIM-413-1	400	600	1Ø3W	65kA	Line side dual 600 Load side single 600	48	25	15	20104-03	20103-811
TBALIM-434-1	400	600	3Ø4W	65kA	Line side dual 600 Load side single 600	48	25	15	20104-03	20103-811
TBALIM-613-2	600	600	1Ø3W	65kA	2 (600)	48	25	15	20104-03	20103-812
TBALIM-634-2	600	600	3Ø4W	65kA	2 (600)	48	25	15	20104-03	20103-812
TBALIM-813-3	800	600	1Ø3W	65kA	3 (600)	48	25	15	20104-03	20103-813
TBALIM-834-3	800	600	3Ø4W	65kA	3 (600)	48	25	15	20104-03	20103-813
TBALIM-1234-5	1200	600	3Ø4W	85kA	5 (600)	54	36	15	20104-07	20103-814

Underground Entry and Underground Exit

Catalog Number	Amps	Voltage	Phase	SCCR	Lugs (size) per Phase	Dimensions			Cabinet Drawing	Bus Drawing
						H"	W"	D"		
TBBXALIM-413-1	400	600	1Ø3W	65kA	Line side dual 600 Load side single 600	48	25	15	20104-03	20103-839
TBBXALIM-434-1	400	600	3Ø4W	65kA	Line side dual 600 Load side single 600	48	25	15	20104-03	20103-839
TBBXALIM-613-2	600	600	1Ø3W	65kA	2 (600)	48	36	15	20104-05	20103-840
TBBXALIM-634-2	600	600	3Ø4W	65kA	2 (600)	48	36	15	20104-05	20103-840
TBBXALIM-813-3	800	600	1Ø3W	65kA	3 (600)	48	36	15	20104-05	20103-841
TBBXALIM-834-3	800	600	3Ø4W	65kA	3 (600)	48	36	15	20104-05	20103-841
TBBXALIM-1234-5	1200	600	3Ø4W	85kA	5 (600)	54	46	15	20104-08	20103-842

Notes

- Line side lugs are 1000 MCM-500 MCM starting at 1600 Amps.

Please consult serving utility for their requirements prior to ordering or installing, as specifications and approvals vary by utility, and may require local electrical inspector approval. All installations must be installed by a licensed electrician and must comply with all national and local codes, laws and regulations. Milbank reserves the right to make changes in specifications and features shown without notice or obligation.



Termination Cabinets

Alliant Area Units | UL-Listed



TBALIM-834-3

Pad-mount

Catalog Number	Amps	Volts	Phase	SCCR	Lugs (size) per Phase	Dimensions			Cabinet Drawing	Bus Drawing
						H"	W"	D"		
TBPMALIM-413-1	400	600	1Ø3W	65kA	Line side dual 600 Load side single 600	58	25	15	20104-03PM	20103-839
TBPMALIM-434-1	400	600	3Ø4W	65kA	Line side dual 600 Load side single 600	58	25	15	20104-03PM	20103-839
TBPMALIM-613-2	600	600	1Ø3W	65kA	2 (600)	58	36	15	20104-05PM	20103-840
TBPMALIM-634-2	600	600	3Ø4W	65kA	2 (600)	58	36	15	20104-05PM	20103-840
TBPMALIM-813-3	800	600	1Ø3W	65kA	3 (600)	58	36	15	20104-05PM	20103-841
TBPMALIM-834-3	800	600	3Ø4W	65kA	3 (600)	58	36	15	20104-05PM	20103-841
TBPMALIM-1234-5	1200	600	3Ø4W	85kA	5 (600)	64	46	15	20104-08PM	20103-842
TBPMALIM-1634-4	1600	600	3Ø4W	85kA	4 (1000)	64	46	15	20104-08PM	20103-843
TBPMALIM-2034-5	2000	600	3Ø4W	85kA	5 (1000)	66	54	15	20104-12PM	20103-844
TBPMALIM-2534-7	2500	600	3Ø4W	85kA	7 (1000)	72	50	21	20104-14PM	20103-845
TBPMALIM-3034-8	3000	600	3Ø4W	85kA	8 (1000)	72	50	21	20104-14PM	20103-846

Notes

- Wire bending space meets the National Electric Code requirements per Tables 373-6(A) and 373-6(B)
- Cabinets are constructed of aluminum and rated NEMA 3R for indoor or outdoor use.
- The hinged door employs a 3-point latch and has provisions for padlocking.
- 600 MCM load lugs are provided.
- 350 MCM, 600 MCM or 1000 MCM line lugs are provided in quantities shown above.
- The neutral bonding strap is provided.
- For "UGBX" and pad-mount, "PM", cabinets with internal wireways the letters "L" for left and "R" for right will indicate which side of the cabinet the wireway will be installed. The standard product for Galva-Closure will have the wireway on the left side. Change the "L" (left) in the catalog number to "R" (right) for a wireway on the right side.
- Line side lugs are 1000 MCM-500 MCM starting at 1600 Amps

Please consult serving utility for their requirements prior to ordering or installing, as specifications and approvals vary by utility, and may require local electrical inspector approval. All installations must be installed by a licensed electrician and must comply with all national and local codes, laws and regulations. Milbank reserves the right to make changes in specifications and features shown without notice or obligation.





ALIM-CTLGL12A-434



ALI-CTPT12A-464

Underground Entry and Overhead Exit | Overhead Entry and Underground Exit

Catalog Number	Amps	Voltage	Phase	SCCR	Pull-Out Switch		Dimensions			Drawing
					Catalog #	Location	H"	W"	D"	
ALIM-CTPT12A-413	400	120/240	1Ø3W	65kA	PAT325-2P	Above CT	72	25	15	20111-114
ALIM-CTPT12A-434	400	208Y/120	3Ø4W	65kA	PAT325	Above CT	72	25	15	20111-115
ALIM-CTPT14A-464	400	480Y/277	3Ø4W	65kA	PAT365	Above CT	72	32	15	20111-116

Underground Entry and Underground Exit

Catalog Number	Amps	Voltage	Phase	SCCR	Pull-Out Switch		Dimensions			Drawing
					Catalog #	Location	H"	W"	D"	
ALIM-CTPT12L-413UGBX	400	120/240	1Ø3W	65kA	PAT325-2P	Left of CT	48	46	15	20111-181
ALIM-CTPT12L-434UGBX	400	208Y/120	3Ø4W	65kA	PAT325	Left of CT	48	46	15	20111-182
ALIM-CTPT14L-464UGBX	400	480Y/277	3Ø4W	65kA	PAT365	Left of CT	48	46	15	20111-183

Pad-mount

Catalog Number	Amps	Voltage	Phase	SCCR	Pull-Out Switch		Dimensions			Drawing
					Catalog #	Location	H"	W"	D"	
ALIM-CTPT12L-413PM	400	120/240	1Ø3W	65kA	PAT325-2P	Left of CT	58	46	15	20111-191
ALIM-CTPT12L-434PM	400	208Y/120	3Ø4W	65kA	PAT325	Left of CT	58	46	15	20111-192
ALIM-CTPT14L-464PM	400	480Y/277	3Ø4W	65kA	PAT365	Left of CT	58	46	15	20111-193

Notes

- Fuses - Use class "T" fuses rated 240 or 600V (Littlefuse JLLN, Bussman JLN, Gould A3T or equal). Fuses can be provided.
- Utility entry can be reversed for UGBX and PM units by changing the "L" after the 12 or 14 to an "R."



Please consult serving utility for their requirements prior to ordering or installing, as specifications and approvals vary by utility, and may require local electrical inspector approval. All installations must be installed by a licensed electrician and must comply with all national and local codes, laws and regulations. Milbank reserves the right to make changes in specifications and features shown without notice or obligation.

Disconnect Cabinets

Alliant Area Units | UL-Listed



ALI-CTMGL12L-634UGBX

Underground Entry and Overhead Exit | Overhead Entry and Underground Exit
(2) 200 Amps Square D Circuit Breakers

Catalog Number	Amps	Voltage	Phase	SCCR	Circuit Breaker		Dimensions			Drawing
					Catalog #	Location	H"	W"	D"	
ALIM-CTJGL22A-413	400	120/240	1Ø3W	65kA	JGL26200	Above CT	72	25	15	20111-131
ALIM-CTJGL22A-434	400	208Y/120	3Ø4W	65kA	JGL36200	Above CT	72	25	15	20111-132
ALIM-CTJGL24A-464	400	480Y/277	3Ø4W	35kA	JGL36200	Above CT	72	32	15	20111-133
ALIM-CTJL24A-464	400	480Y/277	3Ø4W	65kA	JL36200	Above CT	72	32	15	20111-133

Notes

- For top entry/bottom exit, change the "A" in the CT designator to an "B."

Please consult serving utility for their requirements prior to ordering or installing, as specifications and approvals vary by utility, and may require local electrical inspector approval. All installations must be installed by a licensed electrician and must comply with all national and local codes, laws and regulations. Milbank reserves the right to make changes in specifications and features shown without notice or obligation.



Underground Entry and Overhead Exit | Overhead Entry and Underground Exit

(1) 400 Amps Square D Circuit Breaker

Catalog Number	Amps	Voltage	Phase	SCCR	Circuit Breaker		Dimensions			Drawings
					Catalog #	Location	H"	W"	D"	
ALIM-CTLGL12A-413	400	120/240	1Ø3W	65kA	LGL36400U31X	Above CT	72	25	15	20111-131
ALIM-CTLGL12A-434	400	208Y/120	3Ø4W	65kA	LGL36400U31X	Above CT	72	25	15	20111-132
ALIM-CTLGL14A-464	400	480Y/277	3Ø4W	35kA	LGL36400U31X	Above CT	72	32	15	20111-133
ALIM-CTLJL14A-464	400	480Y/277	3Ø4W	65kA	LJL36400U31X	Above CT	72	32	15	20111-133

(1) 600 Amps Square D Circuit Breaker

Catalog Number	Amps	Voltage	Phase	SCCR	Circuit Breaker		Dimensions			Drawings
					Catalog #	Location	H"	W"	D"	
ALIM-CTMGL12A-613	600	120/240	1Ø3W	65kA	MGL26600	Above CT	72	25	15	20111-134
ALIM-CTMGL12A-634	600	208Y/120	3Ø4W	65kA	MGL36600	Above CT	72	25	15	20111-135
ALIM-CTMGL14A-664	600	480Y/277	3Ø4W	35kA	MGL36600	Above CT	72	32	15	20111-136
ALIM-CTMJL14A-664	600	480Y/277	3Ø4W	65kA	MJL36600	Above CT	72	32	15	20111-136

(1) 800 Amps Square D Circuit Breaker

Catalog Number	Amps	Voltage	Phase	SCCR	Circuit Breaker		Dimensions			Drawings
					Catalog #	Location	H"	W"	D"	
ALIM-CTMGL12A-813	800	120/240	1Ø3W	65kA	MGL26800	Above CT	72	25	15	20111-804
ALIM-CTMGL12A-834	800	208Y/120	3Ø4W	65kA	MGL36800	Above CT	72	25	15	20111-805
ALIM-CTMGL14A-864	800	480Y/277	3Ø4W	35kA	MGL36800	Above CT	72	32	15	20111-806
ALIM-CTMJL14A-864	800	480Y/277	3Ø4W	65kA	MJL36800	Above CT	72	32	15	20111-806

(1) 1200 Amps Square D Circuit Breaker

Catalog Number	Amps	Voltage	Phase	SCCR	Circuit Breaker		Dimensions			Drawings
					Catalog #	Location	H"	W"	D"	
ALIM-CTPGL12A-1234	1200	208Y/120	3Ø4W	65kA	PGL36120	Above CT	72	36	15	20111-850
ALIM-CTPGL12A-1264	1200	480Y/277	3Ø4W	35kA	PGL36120	Above CT	72	50	15	20111-851
ALIM-CTPJL14A-1264	1200	480Y/277	3Ø4W	65kA	PJL36120	Above CT	72	50	15	20111-851

Notes

- For top entry/bottom exit, change the "A" in the CT designator to "B."



Please consult serving utility for their requirements prior to ordering or installing, as specifications and approvals vary by utility, and may require local electrical inspector approval. All installations must be installed by a licensed electrician and must comply with all national and local codes, laws and regulations. Milbank reserves the right to make changes in specifications and features shown without notice or obligation.

Disconnect Cabinets

Alliant Area Units | UL-Listed

Underground Entry and Underground Exit

(2) 200 Amps Square D Circuit Breakers

Catalog Number	Amps	Voltage	Phase	SCCR	Circuit Breaker		Dimensions			Drawings
					Catalog #	Location	H"	W"	D"	
ALIM-CTJGL22L-413UGBX	400	120/240	1Ø3W	65kA	JGL26200	Left of CT	48	46	15	20111-184
ALIM-CTJGL22L-434UGBX	400	208Y/120	3Ø4W	65kA	JGL36200	Left of CT	48	46	15	20111-185
ALIM-CTJGL24L-464UGBX	400	480Y/277	3Ø4W	35kA	JGL36200	Left of CT	48	46	15	20111-186
ALIM-CTJL24L-464UGBX	400	480Y/277	3Ø4W	65kA	JL36200	Left of CT	48	46	15	20111-186

(1) 400 Amps Square D Circuit Breaker

Catalog Number	Amps	Voltage	Phase	SCCR	Circuit Breaker		Dimensions			Drawings
					Catalog #	Location	H"	W"	D"	
ALIM-CTLGL12L-413UGBX	400	120/240	1Ø3W	65kA	LGL36400U31X	Left of CT	48	46	15	20111-187
ALIM-CTLGL12L-434UGBX	400	208Y/120	3Ø4W	65kA	LGL36400U31X	Left of CT	48	46	15	20111-188
ALIM-CTLGL14L-464UGBX	400	480Y/277	3Ø4W	35kA	LGL36400U31X	Left of CT	48	46	15	20111-189
ALIM-CTLJL14L-464UGBX	400	480Y/277	3Ø4W	65kA	LJL36400U31X	Left of CT	48	46	15	20111-189

(1) 600 Amps Square D Circuit Breaker

Catalog Number	Amps	Voltage	Phase	SCCR	Circuit Breaker		Dimensions			Drawings
					Catalog #	Location	H"	W"	D"	
ALIM-CTMGL12L-613UGBX	600	120/240	1Ø3W	65kA	MGL26600	Left of CT	54	46	15	20111-844
ALIM-CTMGL12L-634UGBX	600	208Y/120	3Ø4W	65kA	MGL36600	Left of CT	54	46	15	20111-845
ALIM-CTMGL14L-664UGBX	600	480Y/277	3Ø4W	35kA	MGL36600	Left of CT	54	46	15	20111-846
ALIM-CTMJL14L-664UGBX	600	480Y/277	3Ø4W	65kA	MJL36600	Left of CT	54	46	15	20111-846

(1) 800 Amps Square D Circuit Breaker

Catalog Number	Amps	Voltage	Phase	SCCR	Circuit Breaker		Dimensions			Drawings
					Catalog #	Location	H"	W"	D"	
ALIM-CTMGL12L-813UGBX	800	120/240	1Ø3W	65kA	MGL26800	Left of CT	54	46	15	20111-847
ALIM-CTMGL12L-834UGBX	800	208Y/120	3Ø4W	65kA	MGL36800	Left of CT	54	46	15	20111-848
ALIM-CTMGL14L-864UGBX	800	480Y/277	3Ø4W	35kA	MGL36800	Left of CT	54	46	15	20111-849
ALIM-CTMJL14L-864UGBX	800	480Y/277	3Ø4W	65kA	MJL36800	Left of CT	54	46	15	20111-849

(1) 1200 Amps Square D Circuit Breaker

Catalog Number	Amps	Voltage	Phase	SCCR	Circuit Breaker		Dimensions			Drawings
					Catalog #	Location	H"	W"	D"	
ALIM-CTPGL12L-1234UGBX	1200	120/240	3Ø4W	65kA	PGL36120	Left of CT	54	54	15	20111-852
ALIM-CTPGL14L-1264UGBX	1200	208Y/120	3Ø4W	35kA	PGL36120	Left of CT	60	54	15	20111-853
ALIM-CTPJL14L-1264UGBX	1200	480Y/277	3Ø4W	65kA	PJL36120	Left of CT	60	54	15	20111-853

Notes

- To have the breaker on the right, change the second "L" in the CT designator to an "R."

Please consult serving utility for their requirements prior to ordering or installing, as specifications and approvals vary by utility, and may require local electrical inspector approval. All installations must be installed by a licensed electrician and must comply with all national and local codes, laws and regulations. Milbank reserves the right to make changes in specifications and features shown without notice or obligation.



Pad-mount

(2) 200 Amps Square D Circuit Breakers

Catalog Number	Amps	Voltage	Phase	SCCR	Circuit Breaker		Dimensions			Drawings
					Catalog #	Location	H"	W"	D"	
ALIM-CTJGL22L-413PM	400	120/240	1Ø3W	65kA	JGL26200	Left of CT	58	46	15	20111-194
ALIM-CTJGL22L-434PM	400	208Y/120	3Ø4W	65kA	JGL36200	Left of CT	58	46	15	20111-195
ALIM-CTJGL24L-464PM	400	480Y/277	3Ø4W	35kA	JGL36200	Left of CT	58	46	15	20111-196
ALIM-CTJL24L-464PM	400	480Y/277	3Ø4W	65kA	JL36200	Left of CT	58	46	15	20111-196

(1) 400 Amps Square D Circuit Breaker

Catalog Number	Amps	Voltage	Phase	SCCR	Circuit Breaker		Dimensions			Drawings
					Catalog #	Location	H"	W"	D"	
ALIM-CTLGL12L-413PM	400	120/240	1Ø3W	65kA	LGL36400U31X	Left of CT	58	46	15	20111-197
ALIM-CTLGL12L-434PM	400	208Y/120	3Ø4W	65kA	LGL36400U31X	Left of CT	58	46	15	20111-198
ALIM-CTLGL14L-464PM	400	480Y/277	3Ø4W	35kA	LGL36400U31X	Left of CT	58	46	15	20111-199
ALIM-CTLJL14L-464PM	400	480Y/277	3Ø4W	65kA	LJL36400U31X	Left of CT	58	46	15	20111-199

(1) 600 Amps Square D Circuit Breaker

Catalog Number	Amps	Voltage	Phase	SCCR	Circuit Breaker		Dimensions			Drawings
					Catalog #	Location	H"	W"	D"	
ALIM-CTMGL12L-613PM	600	120/240	1Ø3W	65kA	MGL26600	Left of CT	64	46	15	20111-870
ALIM-CTMGL12L-634PM	600	208Y/120	3Ø4W	65kA	MGL36600	Left of CT	64	46	15	20111-871
ALIM-CTMGL14L-664PM	600	480Y/277	3Ø4W	35kA	MGL36600	Left of CT	64	46	15	20111-872
ALIM-CTMJL14L-664PM	600	480Y/277	3Ø4W	65kA	MJL36600	Left of CT	64	46	15	20111-872

(1) 800 Amps Square D Circuit Breaker

Catalog Number	Amps	Voltage	Phase	SCCR	Circuit Breaker		Dimensions			Drawings
					Catalog #	Location	H"	W"	D"	
ALIM-CTMGL12L-813PM	800	120/240	1Ø3W	65kA	MGL26800	Left of CT	64	46	15	20111-873
ALIM-CTMGL12L-834PM	800	208Y/120	3Ø4W	65kA	MGL36800	Left of CT	64	46	15	20111-874
ALIM-CTMGL14L-864PM	800	480Y/277	3Ø4W	35kA	MGL36800	Left of CT	64	46	15	20111-875
ALIM-CTMJL14L-864PM	800	480Y/277	3Ø4W	65kA	MJL36800	Left of CT	64	46	15	20111-875

(1) 1200 Amps Square D Circuit Breaker

Catalog Number	Amps	Voltage	Phase	SCCR	Circuit Breaker		Dimensions			Drawings
					Catalog #	Location	H"	W"	D"	
ALIM-CTPGL12L-1234PM	1200	120/240	3Ø4W	65kA	PGL36120	Left of CT	64	46	15	20111-876
ALIM-CTPGL14L-1264PM	1200	208Y/120	3Ø4W	35kA	PGL36120	Left of CT	70	54	15	20111-877
ALIM-CTPJL14L-1264PM	1200	480Y/277	3Ø4W	65kA	PJL36120	Left of CT	70	54	15	20111-877

Notes

- To have the breaker on the right, change the second "L" in the CT designator to an "R."



Please consult serving utility for their requirements prior to ordering or installing, as specifications and approvals vary by utility, and may require local electrical inspector approval. All installations must be installed by a licensed electrician and must comply with all national and local codes, laws and regulations. Milbank reserves the right to make changes in specifications and features shown without notice or obligation.

Cable-Closure™ Wireways

Alliant Area Units | UL-Listed

53

Catalog Number	Amps	Cabinet Size			Ship Weight
		H"	W"	D"	
CCM-36	800	36	10.5	6	33
CCM-48	800	48	10.5	6	43
CCM-60	800	60	10.5	6	53
CCLM-22	1600	22	10.5	10.5	28
CCLM-36	1600	36	10.5	10.5	42
CCLM-48	1600	48	10.5	10.5	55
CCLM-60	1600	60	10.5	10.5	69

Please consult serving utility for their requirements prior to ordering or installing, as specifications and approvals vary by utility, and may require local electrical inspector approval. All installations must be installed by a licensed electrician and must comply with all national and local codes, laws and regulations. Milbank reserves the right to make changes in specifications and features shown without notice or obligation.



Underground Entry and Overhead Exit

Catalog Number	Amps	Voltage	Phase	SCCR	Dimensions			Cabinet Drawing	Bus Drawing
					H"	W"	D"		
MAEM-613	600	250	1Ø3W	65kA	48	25	10	20104-04	20104-816
MAEM-634	600	250	3Ø4W	65kA	48	25	10	20104-04	20104-816
MAEM-813	800	250	1Ø3W	65kA	48	25	10	20104-04	20104-825A
MAEM-834	800	250	3Ø4W	65kA	48	25	10	20104-04	20104-825A
MAEM-1213	1200	250	1Ø3W	85kA	48	36	14	20104-05	20104-831
MAEM-1234	1200	250	3Ø4W	85kA	48	36	14	20104-05	20104-831
MAEM-1634	1600	250	3Ø4W	85kA	48	36	14	20104-05	20104-848
MAEM-2034	2000	250	3Ø4W	85kA	66	42	14	20104-16	20104-867A
MAEM-2534	2500	250	3Ø4W	85kA	72	42	20	20104-13	20104-874A
MAEM-3034	3000	250	3Ø4W	85kA	72	42	20	20104-13	20104-876A

277/480V Units with Provisions for Mounting Three Potential Transformers

Overhead or Underground Entry and Underground Exit

Catalog Number	Amps	Voltage	Phase	SCCR	Dimensions			Cabinet Drawing	Bus Drawing
					H"	W"	D"		
MAEM-664	600	600	3Ø4W	65kA	48	36	14	20104-05	20104-817
MAEM-864	800	600	3Ø4W	65kA	48	36	14	20104-05	20104-827
MAEM-1264	1200	600	3Ø4W	85kA	48	46	12	20104-06	20104-897
MAEM-1664	1600	600	3Ø4W	85kA	48	46	12	20104-06	20104-849
MAEM-2064	2000	600	3Ø4W	85kA	66	54	14	20104-12	20104-868A
MAEM-2564	2500	600	3Ø4W	85kA	72	50	20	20104-14	20104-875A
MAEM-3064	3000	600	3Ø4W	85kA	72	50	20	20104-14	20104-877A

Underground Entry and Underground Exit

Catalog Number	Amps	Voltage	Phase	SCCR	Dimensions			Cabinet Drawing	Bus Drawing
					H"	W"	D"		
MAEM-613UGBX	600	250	1Ø3W	65kA	48	36	14	20104-05	20104-767
MAEM-634UGBX	600	250	3Ø4W	65kA	48	36	14	20104-05	20104-767
MAEM-813UGBX	800	250	1Ø3W	65kA	48	36	14	20104-05	20104-768A
MAEM-834UGBX	800	250	3Ø4W	85kA	48	36	14	20104-05	20104-768A
MAEM-1213UGBX	1200	250	1Ø3W	85kA	54	46	14	20104-08	20104-769
MAEM-1234UGBX	1200	250	3Ø4W	85kA	54	46	14	20104-08	20104-769
MAEM-1634UGBX	1600	250	3Ø4W	85kA	66	54	14	20104-12	20104-770A
MAEM-2034UGBX	2000	250	3Ø4W	85kA	66	54	14	20104-12	20104-771A
MAEM-2534UGBX	2500	250	3Ø4W	85kA	72	50	20	20104-14	20104-772A
MAEM-3034UGBX	3000	250	3Ø4W	85kA	72	50	20	20104-14	20104-773A



Please consult serving utility for their requirements prior to ordering or installing, as specifications and approvals vary by utility, and may require local electrical inspector approval. All installations must be installed by a licensed electrician and must comply with all national and local codes, laws and regulations. Milbank reserves the right to make changes in specifications and features shown without notice or obligation.

Transformer Cabinets

MidAmerican Energy Area Units | UL-Listed

Underground Entry and Underground Exit

Catalog Number	Amps	Voltage	Phase	SCCR	Dimensions			Cabinet Drawing	Bus Drawing
					H"	W"	D"		
MAEM-664UGBX	600	600	3Ø4W	65kA	48	36	14	20104-05	20104-775
MAEM-864UGBX	800	600	3Ø4W	65kA	48	36	14	20104-05	20104-776A
MAEM-1264UGBX	1200	600	3Ø4W	85kA	48	54	14	20104-10	20104-777A
MAEM-1664UGBX	1600	600	3Ø4W	85kA	66	60	14	20104-17	20104-778A
MAEM-2064UGBX	2000	600	3Ø4W	85kA	66	60	14	20104-17	20104-779A
MAEM-2564UGBX	2500	600	3Ø4W	85kA	72	60	20	20104-15	20104-780A
MAEM-3064UGBX	3000	600	3Ø4W	85kA	72	60	20	20104-15	20104-781A

Pad-mount

600V, 3Ø4W Units with Provisions for Mounting Three Potential Transformers

Catalog Number	Amps	Voltage	Phase	SCCR	Dimensions			Cabinet Drawing	Bus Drawing
					H"	W"	D"		
MAEM-613PM	600	250	1Ø3W	65kA	58	36	14	20104-05PM	20104-767
MAEM-634PM	600	250	3Ø4W	65kA	58	36	14	20104-05PM	20104-767
MAEM-813PM	800	250	1Ø3W	65kA	58	36	14	20104-05PM	20104-768A
MAEM-834PM	800	250	3Ø4W	65kA	58	36	14	20104-05PM	20104-768A
MAEM-1213PM	1200	250	1Ø3W	85kA	64	46	14	20104-08PM	20104-769
MAEM-1234PM	1200	250	3Ø4W	85kA	64	46	14	20104-08PM	20104-769
MAEM-1634PM	1600	250	3Ø4W	85kA	66	54	14	20104-12PM	20104-770A
MAEM-2034PM	2000	250	3Ø4W	85kA	66	54	14	20104-12PM	20104-771A
MAEM-2534PM	2500	250	3Ø4W	85kA	72	50	20	20104-14PM	20104-772A
MAEM-3034PM	3000	250	3Ø4W	85kA	72	50	20	20104-14PM	20104-773A

600V, 3Ø4W Units with Provisions for Mounting Three Potential Transformers

Catalog Number	Amps	Voltage	Phase	SCCR	Dimensions			Cabinet Drawing	Bus Drawing
					H"	W"	D"		
MAEM-664PM	600	600	3Ø4W	65kA	58	36	14	20104-05PM	20104-775
MAEM-864PM	800	600	3Ø4W	65kA	58	36	14	20104-05PM	20104-776A
MAEM-1264PM	1200	600	3Ø4W	85kA	58	54	14	20104-10PM	20104-777A
MAEM-1664PM	1600	600	3Ø4W	85kA	66	60	14	20104-17PM	20104-778A
MAEM-2064PM	2000	600	3Ø4W	85kA	66	60	14	20104-17PM	20104-779A
MAEM-2564PM	2500	600	3Ø4W	85kA	72	60	20	20104-15PM	20104-780A
MAEM-3064PM	3000	600	3Ø4W	85kA	72	60	20	20104-15PM	20104-781A

Please consult serving utility for their requirements prior to ordering or installing, as specifications and approvals vary by utility, and may require local electrical inspector approval. All installations must be installed by a licensed electrician and must comply with all national and local codes, laws and regulations. Milbank reserves the right to make changes in specifications and features shown without notice or obligation.



200 Amps | 4-5 Terminals | Ringless | 600V

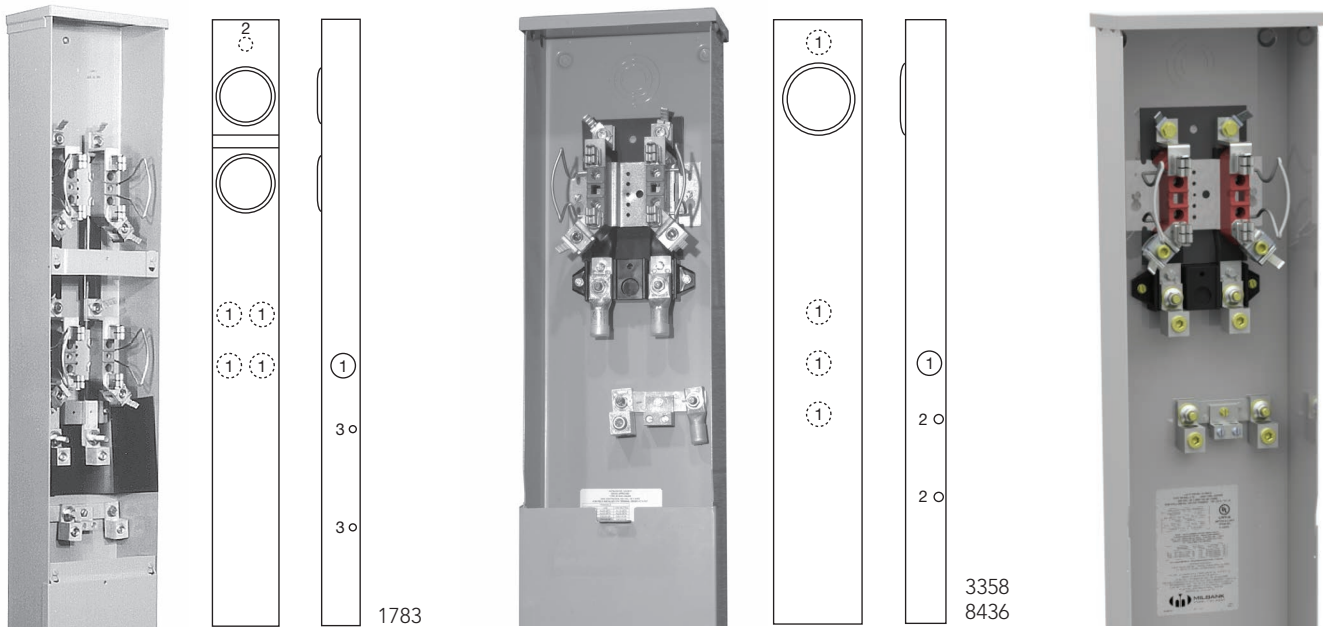

U1783-O-KK-5T

U8436-O-CECHA

U3358-O-KK

Alliant Approved | 200 Amps | 4-5 Terminals | Horn Bypass | Ringless

Catalog Number	Positions	Terminals	Service	Hub	Connectors CU/AL		Dimensions			Knockouts		
					Line	Load	D"	W"	H"	1	2	3
U3358-O-KK-ALT	1	4	UG	Blank	#6-350	#6-350	4 $\frac{1}{8}$	9	62	2	$\frac{3}{4}$	—
U3358-O-KK-5T	1	5	UG	Blank	#6-350	#6-350	4 $\frac{1}{8}$	9	62	2	$\frac{3}{4}$	—
U1783-O-KK	2	4	UG	Blank	#6-350	#6-350	4 $\frac{1}{2}$	8 $\frac{1}{5}$	74	2 $\frac{1}{2}$	1 $\frac{1}{3}$	$\frac{1}{2}$
U1783-O-KK-5T	2	5	UG	Blank	#6-350	#6-350	4 $\frac{1}{2}$	8 $\frac{1}{5}$	74	2 $\frac{1}{2}$	1 $\frac{1}{3}$	$\frac{1}{2}$

MidAmerican Approved | 200 Amps | 4 Terminals | Horn Bypass | Ringless

Catalog Number	Terminals	Service	Hub	Connectors CU/AL		Dimensions			Knockouts	
				Line	Load	D"	W"	H"	1	2
U3358-O-KK	4	UG	Blank	#6-350	#6-350	4 $\frac{1}{8}$	9	62	2	$\frac{3}{4}$
U8436-O-CECHA	4	UG	Blank	4/0 Crimp-On	#6-350	4 $\frac{1}{8}$	9	62	2	$\frac{3}{4}$

Notes

- **U8436-O:** Line side lugs are crimp-on style.
- **Fifth Terminal:** For field-installable fifth terminal, order **K5T**.



Please consult serving utility for their requirements prior to ordering or installing, as specifications and approvals vary by utility, and may require local electrical inspector approval. All installations must be installed by a licensed electrician and must comply with all national and local codes, laws and regulations. Milbank reserves the right to make changes in specifications and features shown without notice or obligation.

Lever Bypass Meter Pedestals

57

200 Amps | 4-5 Terminals | Ringless



U4724-O

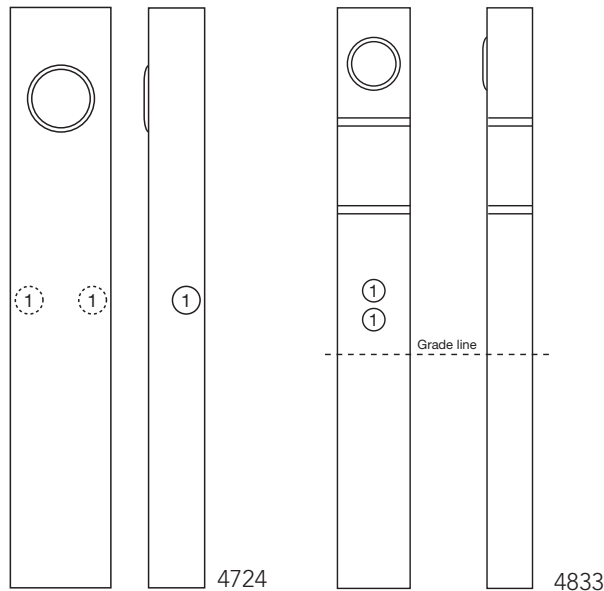

Alliant Approved | 200 Amps | Lever Bypass | Ringless

Catalog Number	Terminals	Voltage	Service	Hub	Connectors CU/AL		Dimensions			Knockouts
					Line	Load	D"	W"	H"	1
U4724-O	4	600	UG	Blank	3/0-4/0	#6-350	6	11	64	2½

MidAmerican and Alliant Approved | 200 Amps | Lever Bypass | Ringless

Catalog Number	Terminals	Voltage	Service	Hub	Connectors CU/AL		Dimensions			Knockouts
					Line	Load	D"	W"	H"	1
U4833-O-5T9	4	120/240	UG	Blank	3/0-4/0	#6-350	6	10⅞	79	2½
U4724-O	4	600	UG	Blank	3/0-4/0	#6-350	6	11	64	2½

Notes

- **Lever Bypass:** Lever provides clamping action on meter spades and also operates bypass device.
- **Fifth Terminal:** For field-installable fifth terminal, order catalog number **K3865** (neutral wire provided) or **K3866** (no neutral wire). Units with **-5T9** suffix supplied with factory-installed fifth terminals at 9 o'clock position.

Please consult serving utility for their requirements prior to ordering or installing, as specifications and approvals vary by utility, and may require local electrical inspector approval. All installations must be installed by a licensed electrician and must comply with all national and local codes, laws and regulations. Milbank reserves the right to make changes in specifications and features shown without notice or obligation.



Lever Bypass Meter Pedestal

200 Amps | 7 Terminals | Ringless | 600V

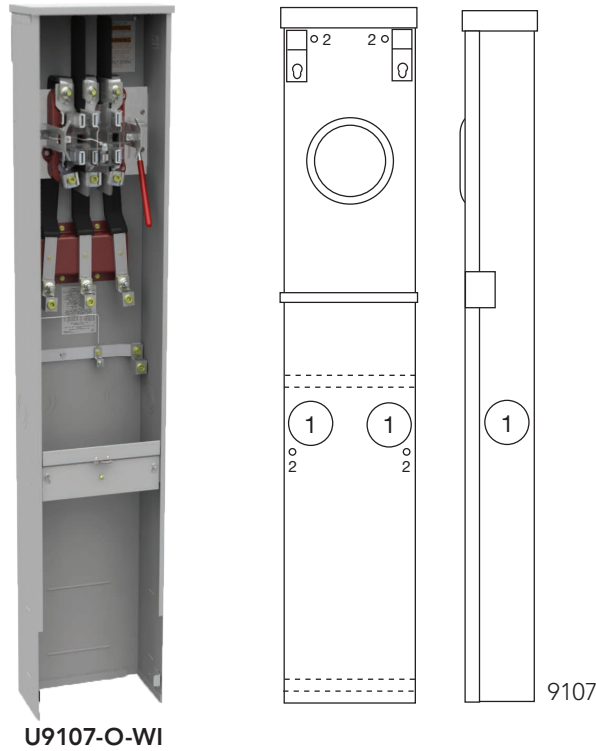

Alliant and MidAmerican Approved | 200 Amps | Lever Bypass | Ringless

Catalog Number	Terminals	Service	Hub	Connectors CU/AL		Bypass	Dimensions			Knockouts	
				Line	Load		D"	W"	H"	1	2
U9107-O-WI	7	UG	Blank	3/0-4/0	#6-350	Lever	6	11	58	2½	5/16

Notes

- **Bypass:** The lever operates bypass device and supplies clamping action to meter spades.
- **Direct Burial:** For free standing use, order burial kit **S3488** separately.



Please consult serving utility for their requirements prior to ordering or installing, as specifications and approvals vary by utility, and may require local electrical inspector approval. All installations must be installed by a licensed electrician and must comply with all national and local codes, laws and regulations. Milbank reserves the right to make changes in specifications and features shown without notice or obligation.

Meter Main with Load Center Pedestals

59

100-200 Amps | 4 Terminals | Ringless

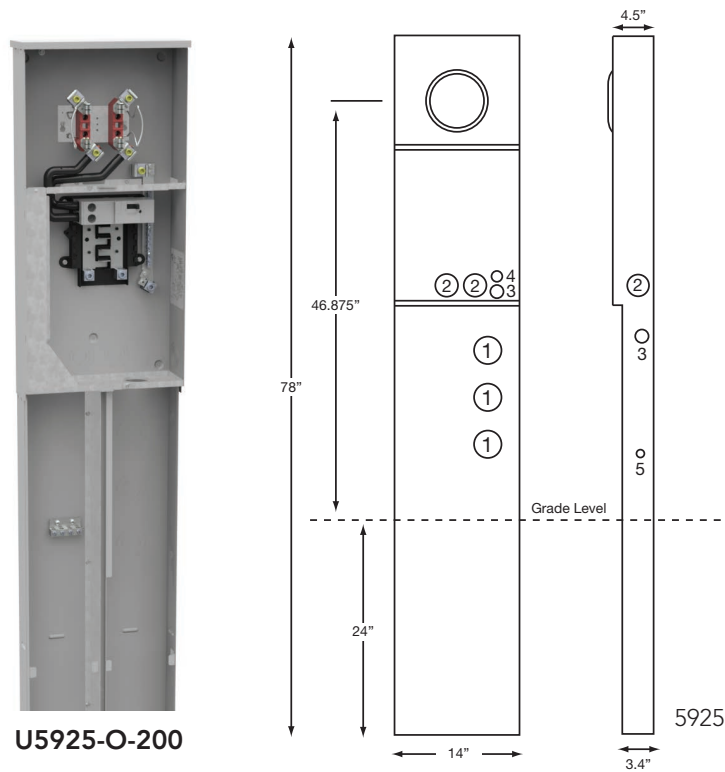

U5925-O-200

Alliant Approved | 4 Terminals | Ringless

Catalog Number	Service	Connectors CU/AL		Bypass	Knockouts				
		Line	Load		1	2	3	4	5
U5925-O-100-KK-ALT	UG	#6-350	CB	Horn	2½	2	1	½,¾	¼,½
U5925-O-150-KK-ALT	UG	#6-350	CB	Horn	2½	2	1	½,¾	¼,½
U5925-O-200-KK-ALT	UG	#6-350	CB	Horn	2½	2	1	½,¾	¼,½

MidAmerican Approved | 4 Terminals | Ringless

Catalog Number	Service	Connectors CU/AL		Bypass	Knockouts				
		Line	Load		1	2	3	4	5
U5925-O-100-KK	UG	#6-350	CB	Horn	2½	2	1	½,¾	¼,½
U5925-O-150-KK	UG	#6-350	CB	Horn	2½	2	1	½,¾	¼,½
U5925-O-200-KK	UG	#6-350	CB	Horn	2½	2	1	½,¾	¼,½

Notes

- **NEC 2020 Compliant:** All products are NEC 2020 Compliant.
- **Fifth Terminal:** For field-installable fifth terminal, order **K5T**.
- **Interlock Kit:** For generator auxiliary circuit breakers interlock, order **K5815** for large frame QN with small frame Q; order **K5820** for larger frame QN with larger frame QN; and order **K5830** for small frame Q with small frame Q.
- **Branch Circuit Breakers:** Branch interior accepts most manufacturers' small frame plug-in type circuit breakers (GE, Siemens, Cutler-Hammer, Murray).
- **Note:** Ten additional one-pole spaces for 100 Amps version and eight additional one-pole spaces for 200 Amps version.

Please consult serving utility for their requirements prior to ordering or installing, as specifications and approvals vary by utility, and may require local electrical inspector approval. All installations must be installed by a licensed electrician and must comply with all national and local codes, laws and regulations. Milbank reserves the right to make changes in specifications and features shown without notice or obligation.



60 Meter Main with Load Center Pedestals

200 Amps | 4 Terminals | Ringless | 120/240V



U5136-O-200S

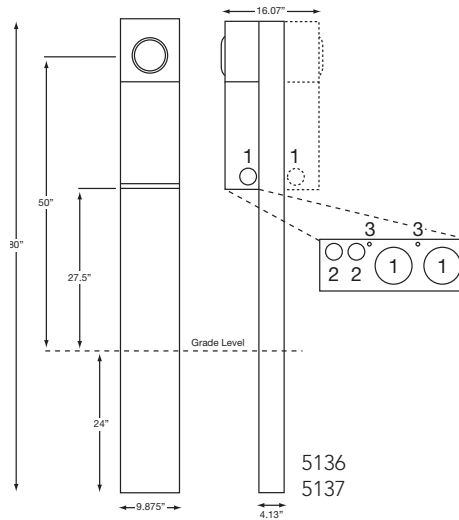

Alliant Approved | 200 Amps | 4 Terminals | Ringless

Catalog Number	Service	AIC Rating	Connectors CU/AL		Bypass	Dimensions			Knockouts		
			Line	Load		D"	W"	H"	1	2	3
U5136-O-100S-ALT	UG	22K	#6-350	CB	Horn	4 $\frac{1}{8}$	9 $\frac{7}{8}$	80	2	1/2, 3/4	1/4
U5136-O-200S-ALT	UG	22K	#6-350	CB	Horn	4 $\frac{1}{8}$	9 $\frac{7}{8}$	80	2	1/2, 3/4	1/4
U5137-O-100S-ALT	UG	22K	#6-350	CB	Horn	4 $\frac{1}{8}$	9 $\frac{7}{8}$	80	2	1/2, 3/4	1/4
U5137-O-200S-ALT	UG	22K	#6-350	CB	Horn	4 $\frac{1}{8}$	9 $\frac{7}{8}$	80	2	1/2, 3/4	1/4

MidAmerican Approved | 200 Amps | 4 Terminals | Ringless

Catalog Number	Service	AIC Rating	Connectors CU/AL		Bypass	Dimensions			Knockouts		
			Line	Load		D"	W"	H"	1	2	3
U5136-O-100S	UG	22K	#6-350	CB	Horn	4 $\frac{1}{8}$	9 $\frac{7}{8}$	80	2	1/2, 3/4	1/4
U5136-O-150S	UG	22K	#6-350	CB	Horn	4 $\frac{1}{8}$	9 $\frac{7}{8}$	80	2	1/2, 3/4	1/4
U5136-O-200S	UG	22K	#6-350	CB	Horn	4 $\frac{1}{8}$	9 $\frac{7}{8}$	80	2	1/2, 3/4	1/4
U5137-O-100S	UG	22K	#6-350	CB	Horn	4 $\frac{1}{8}$	9 $\frac{7}{8}$	80	2	1/2, 3/4	1/4
U5137-O-150S	UG	22K	#6-350	CB	Horn	4 $\frac{1}{8}$	9 $\frac{7}{8}$	80	2	1/2, 3/4	1/4
U5137-O-200S	UG	22K	#6-350	CB	Horn	4 $\frac{1}{8}$	9 $\frac{7}{8}$	80	2	1/2, 3/4	1/4

Notes

- **NEC 2020 Compliant:** All products are NEC 2020 Compliant.
- **Fifth Terminal:** For field-installable fifth terminal, order **K5T**.
- **Stabilizer Foot:** For field-installable stabilizer foot, order **K5415**.
- **Penta Bolt Locking:** For field-installable pedestal fronts with penta bolt locking, order **K5039**.
- **Receptacles:** Consult factory for installed receptacle assemblies.
- **Short Circuit Current Rating:** 22K AIC. However, this rating is limited to the lowest interrupting capacity of any circuit breaker installed. Watthour meter not included in short circuit current rating.
- **U5137:** Double power head version.



Please consult serving utility for their requirements prior to ordering or installing, as specifications and approvals vary by utility, and may require local electrical inspector approval. All installations must be installed by a licensed electrician and must comply with all national and local codes, laws and regulations. Milbank reserves the right to make changes in specifications and features shown without notice or obligation.

Meter Main with Load Center Pedestals 6 1

100-200 Amps | 4 Terminals | Ringless | 240V



U4322-O

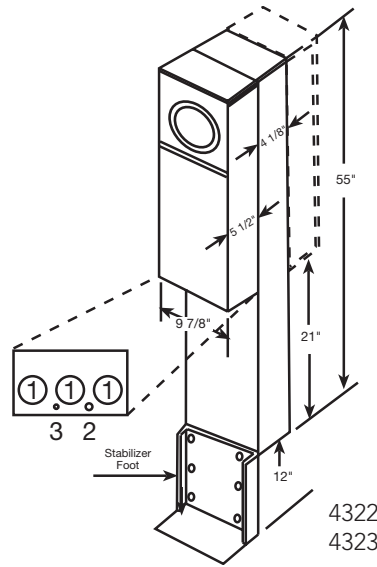

4322
4323

Alliant Approved | 100 Amps | 4 Terminals | Ringless

Catalog Number	Bypass	Meter Positions	Twin Line Connectors CU/AL	Circuit Provisions	Knockouts			Dimensions		
					1	2	3	D"	W"	H"
U4322-O-100MB	Lever	Single	#6-350	6	2	1/2	1/4	9 5/8	9 7/8	55
U4323-O-100MB	Lever	Double	#6-350	6	2	1/2	1/4	15 1/8	9 7/8	55

MidAmerican Approved | 100-200 Amps | 4 Terminals | Ringless

Catalog Number	Bypass	Meter Positions	Twin Line Connectors CU/AL	Circuit Provisions	Knockouts			Dimensions		
					1	2	3	D"	W"	H"
U4322-O-100MB	Lever	Single	#6-350	6	2	1/2	1/4	9 5/8	9 7/8	55
U4322-O-200MB	Lever	Single	#6-350	6	2	1/2	1/4	9 5/8	9 7/8	55
U4323-O-100MB	Lever	Double	#6-350	6	2	1/2	1/4	15 1/8	9 7/8	55
U4323-O-200MB	Lever	Double	#6-350	6	2	1/2	1/4	9 5/8	9 7/8	55

Notes

- **NEC 2020 Compliant:** All products are NEC 2020 Compliant.
- **Fifth Terminal:** For field-installable fifth terminal, order **K3865**.
- **Bypass:** Lever provides clamping action on meter spades and also operates bypass device
- **Application:** The **U4322** and **U4323** pedestals are suitable for use as service equipment or mobile home service equipment. For pad-mounting, order kit **K5151**.
- **Breakers:** Quadplex style breakers may be used in accordance to the NEC. If main breaker is used, there are provisions for two two-pole breakers for four one-pole breakers in series.
- **Short Circuit Current Rating:** 10K AIC. However, this rating is limited to the lowest interrupting capacity of any circuit breaker installed. Watthour meter not included in short circuit current rating.

Please consult serving utility for their requirements prior to ordering or installing, as specifications and approvals vary by utility, and may require local electrical inspector approval. All installations must be installed by a licensed electrician and must comply with all national and local codes, laws and regulations. Milbank reserves the right to make changes in specifications and features shown without notice or obligation.



62

Meter Main with Load Center Pedestals

200 Amps | 4 Terminals | Ringless

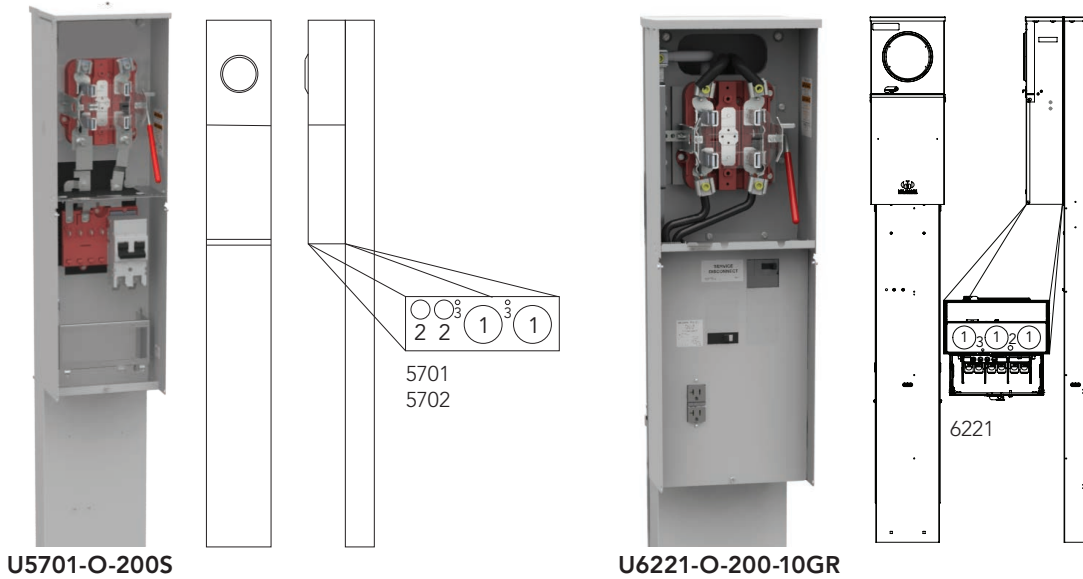

Alliant and MidAmerican Approved | 200 Amps | 4 Terminals | Lever Bypass | Ringless

Catalog Number	Meter Positions	Service	Connectors CU/AL		Circuit Provisions	Bypass	Knockouts		
			Line	Load			1	2	3
U5701-O-100S	Single	UG	#6-350	CB	4	Lever	2	1/2, 3/4	1/4
U5701-O-200S	Single	UG	#6-350	CB	4	Lever	2	1/2, 3/4	1/4
U5702-O-100S	Double	UG	#6-350	CB	4	Lever	2	1/2, 3/4	1/4
U5702-O-200S	Double	UG	#6-350	CB	4	Lever	2	1/2, 3/4	1/4

Alliant Approved | 200 Amps | 4 Terminals | Lever Bypass | Ringless

Catalog Number	Meter Positions	Service	Connectors CU/AL		Circuit Provisions	Bypass	Knockouts		
			Line	Load			1	2	3
U6221-O-100-10GR†	Single	UG	#6-350	CB	10	Lever	2	1/2	1/4
U6221-O-200-10GR†	Single	UG	#6-350	CB	8	Lever	2	1/2	1/4

Notes

- **NEC 2020 Compliant:** All pedestals with a factory-installed main breaker are NEC 2020 compliant.
- **Parallel to Series Conversion:** For the U5701 and U5702 without main breakers, in order to field convert from parallel wired to series wired, order K5194.
- **Bypass:** Lever provides clamping action on meter spades and also operates bypass device
- **Fifth Terminal:** For field-installable fifth terminal, order K3865.
- **Stabilizer Foot:** For field-installable stabilizer foot, order K5415.
- **Receptacles:** Consult factory for installed receptacle assemblies.
- **AIC Rating:** All models are rated 22K AIC.

*Circuit breaker not included.

†U6221 with -10GR has 20 Amps GFI receptacle installed from factory.



Please consult serving utility for their requirements prior to ordering or installing, as specifications and approvals vary by utility, and may require local electrical inspector approval. All installations must be installed by a licensed electrician and must comply with all national and local codes, laws and regulations. Milbank reserves the right to make changes in specifications and features shown without notice or obligation.

Lever Bypass Residential Pedestals

63

300-320 Amps Continuous | 400 Amps Max | 4-5 Terminals

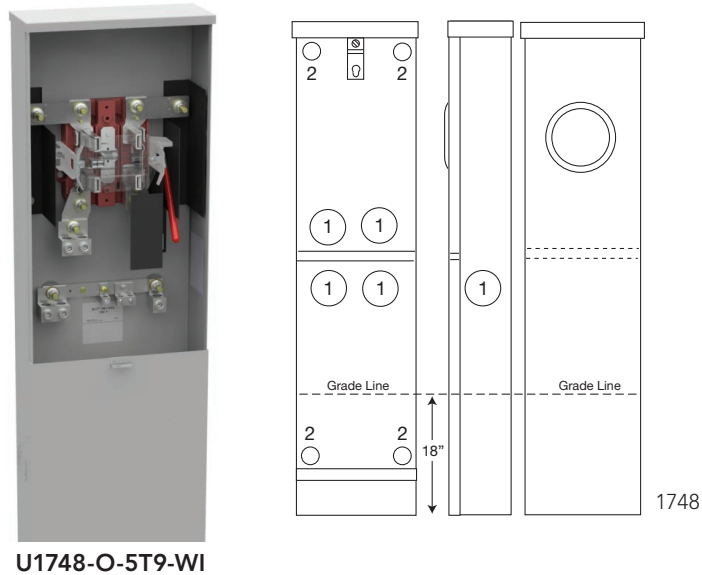

U1748-O-5T9-WI

Alliant Approved | Ringless

Catalog Number	Amps	Terminals	Service	Hub	Connectors CU/AL		Bypass	Dimensions			Knockouts	
					Line	Load		D"	W"	H"	1	2
U1748-O-WI*	300	4	UG	Blank	#6-350	Twin #6-350	Lever	4 ⁷ / ₈	13	64	2 ¹ / ₂	5 ¹ / ₆
U1748-O-5T9-WI*	300	5	UG	Blank	#6-350	Twin #6-350	Lever	4 ⁷ / ₈	13	64	2 ¹ / ₂	5 ¹ / ₆
U6318-O-2/150-K3L	300	4	UG	Blank	3/8" x 16 Studs	Twin #6-350	Lever	4 ⁷ / ₈	13	64	2 ¹ / ₂	5 ¹ / ₆
U6318-O-100-200-K3L	300	4	UG	Blank	3/8" x 16 Studs	Twin #6-350	Lever	4 ⁷ / ₈	13	64	2 ¹ / ₂	5 ¹ / ₆
U6318-O-2/200-K3L†	320	4	UG	Blank	3/8" x 16 Studs	Twin #6-350	Lever	4 ⁷ / ₈	13	64	2 ¹ / ₂	5 ¹ / ₆

MidAmerican Approved | 320 Amps | Ringless

Catalog Number	Terminals	Service	Hub	Connectors CU/AL		Bypass	Dimensions			Knockouts	
				Line	Load		D"	W"	H"	1	2
U1748-O*	4	UG	Blank	3/8" x 16 Studs	Twin #6-350	Lever	4 ⁷ / ₈	13	64	2 ¹ / ₂	5 ¹ / ₆
U6318-O-2/200-K3L	4	UG	Blank	3/8" x 16 Studs	Twin #6-350	Lever	4 ⁷ / ₈	15	80	2 ¹ / ₂	5 ¹ / ₆
U6318-O-2/150-K3L	4	UG	Blank	3/8" x 16 Studs	Twin #6-350	Lever	4 ⁷ / ₈	15	80	2 ¹ / ₂	5 ¹ / ₆
U6318-O-100-200-K3L	4	UG	Blank	3/8" x 16 Studs	Twin #6-350	Lever	4 ⁷ / ₈	15	80	2 ¹ / ₂	5 ¹ / ₆

Notes

- **NEC 2020 Compliant:** U6318 pedestals are NEC 2020 compliant.
- **Bypass:** The lever supplies clamping action on the meter spade and also operates the bypass device.
- **Connectors:** Sockets are supplied with 3/8"-16 hex head nuts with Belleville washers. For connector lug kits, order as extra from chart on the accessories page. Lug kit required for line side only.
- **Direct Burial:** For free standing use, order burial kit **S1848** separately.
- **Anti-Inversion Kit:** If anti-inversion kit is required, order catalog number **K4802** as extra.
- **Short Circuit Current Rating:** 22K AIC. However, this rating is limited to the lowest interrupting capacity of any circuit breaker installed. Watthour meter not included in short circuit current rating.

*No breaker provision.

†Alliant approved for residential applications.

Please consult serving utility for their requirements prior to ordering or installing, as specifications and approvals vary by utility, and may require local electrical inspector approval. All installations must be installed by a licensed electrician and must comply with all national and local codes, laws and regulations. Milbank reserves the right to make changes in specifications and features shown without notice or obligation.



Temporary Power Units

100-125 Amps | 4 Terminals | Ringless | 120/240V



U4908-O-100MB-KK-11GR

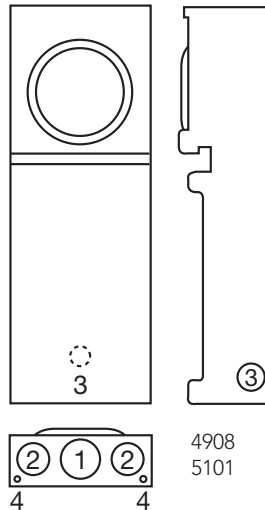

U5101-XL-11GR

100-125 Amps | 4 Terminals | Ringless | 1Ø3W

Catalog Number	Amps	Service	Hub	Connectors CU/AL		Dimensions			Knockouts			
				Line	Load	D"	W"	H"	1	2	3	4
U4908-O-100MB-KK-11GR	100	UG	Blank	#6-2/0	#6-2/0	5 ³ / ₁₆	9	25 ¹⁵ / ₁₆	2	1 ¹ / ₂	1 ¹ / ₄	1 ¹ / ₄
U4908-O-100MB-KK-76GBGR	100	UG	Blank	#6-2/0	#6-2/0	5 ³ / ₁₆	9	25 ¹⁵ / ₁₆	2	1 ¹ / ₂	1 ¹ / ₄	1 ¹ / ₄
U5101-XL-11GR	125	OH	C.P.	#6-350	#6-350	5 ³ / ₁₆	8 ⁷ / ₈	25	2	1 ¹ / ₂	1 ¹ / ₄	1 ¹ / ₄
U5101-RL-100MB-KK-76GBGR	125	OH	C.P.	#6-350	#6-350	5 ³ / ₁₆	8 ⁷ / ₈	25	2	1 ¹ / ₂	1 ¹ / ₄	1 ¹ / ₄
U5101-100MB-KK-11GR	125	OH	C.P.	#6-350	#6-350	5 ³ / ₁₆	8 ⁷ / ₈	25	2	1 ¹ / ₂	1 ¹ / ₄	1 ¹ / ₄

Notes

- **NEC 2020 Compliant:** Products with -100MB main breaker suffix are NEC 2020 compliant.
- **Interior:** Six circuit plated copper interior accepts standard plug-in type circuit breakers.
- **Receptacle Bridge:** Three position self-grounded receptacle bridge accepts most standard NEMA receptacles with mounting plates.
- **Included Parts:** Units come supplied with two 20 Amps one-pole breakers and two 20 Amps GFCI receptacles (prewired and installed).



Please consult serving utility for their requirements prior to ordering or installing, as specifications and approvals vary by utility, and may require local electrical inspector approval. All installations must be installed by a licensed electrician and must comply with all national and local codes, laws and regulations. Milbank reserves the right to make changes in specifications and features shown without notice or obligation.

Power Outlet Pedestals

65

Voyager Series | Unmetered | 120/240V

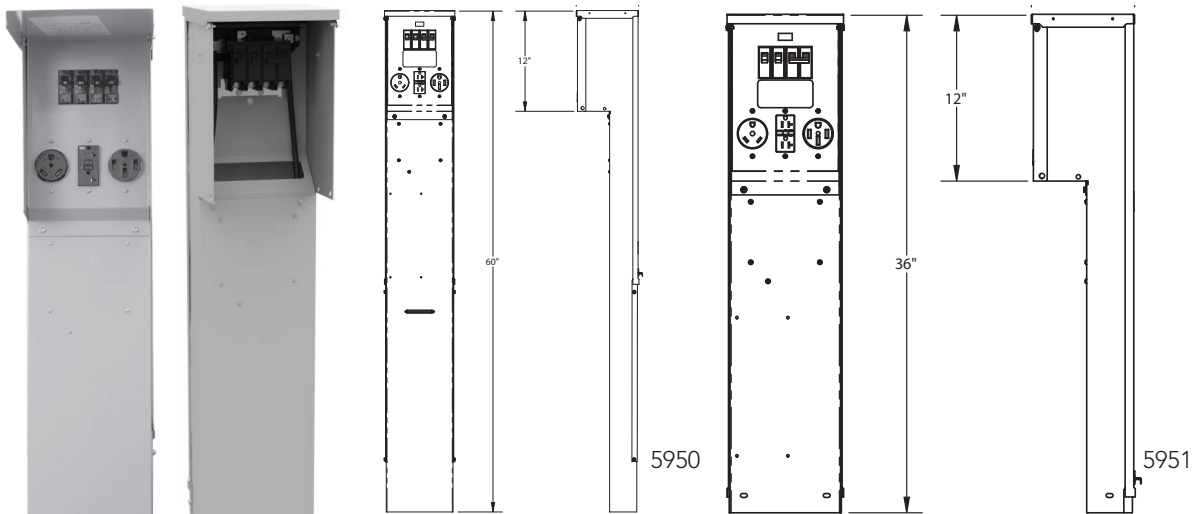

U5950-O-75

100 Amps | Unmetered | Ringless

Catalog Number	Mounting Type	Receptacle Configuration	Circuit Breaker Configuration	Dimensions		
				D"	W"	H"
U5950-O-41	Direct Burial	A	X	3¼	8	60
U5950-O-55	Direct Burial	B	Y	3¼	8	60
U5950-O-75	Direct Burial	C	Z	3¼	8	60
U5951-O-41	Pad-Mount	A	X	3¼	8	36
U5951-O-55	Pad-Mount	B	Y	3¼	8	36
U5951-O-75	Pad-Mount	C	Z	3¼	8	36

Receptacle Configurations

A	B	C
(1) TT30R, (1) 5-20R GFI	(1) 14-50R, (1) 5-20R GFI	(1) 14-50R, (1) TT30R, (1) 5-20R GFI

Circuit Breaker Configurations

X	Y	Z
(1) 30A, 1P, 120V (1) 20A, 1P, 120V	(1) 50A, 2P, 120/240V (1) 20A, 1P, 120V	(1) 50A, 2P, 120/240V (1) 30A, 1P, 120V (1) 20A, 1P, 120V

Note

Contact factory for additional configurations not shown here.

Please consult serving utility for their requirements prior to ordering or installing, as specifications and approvals vary by utility, and may require local electrical inspector approval. All installations must be installed by a licensed electrician and must comply with all national and local codes, laws and regulations. Milbank reserves the right to make changes in specifications and features shown without notice or obligation.



Power Outlet Pedestals

Voyager Series | Metered | 120/240V

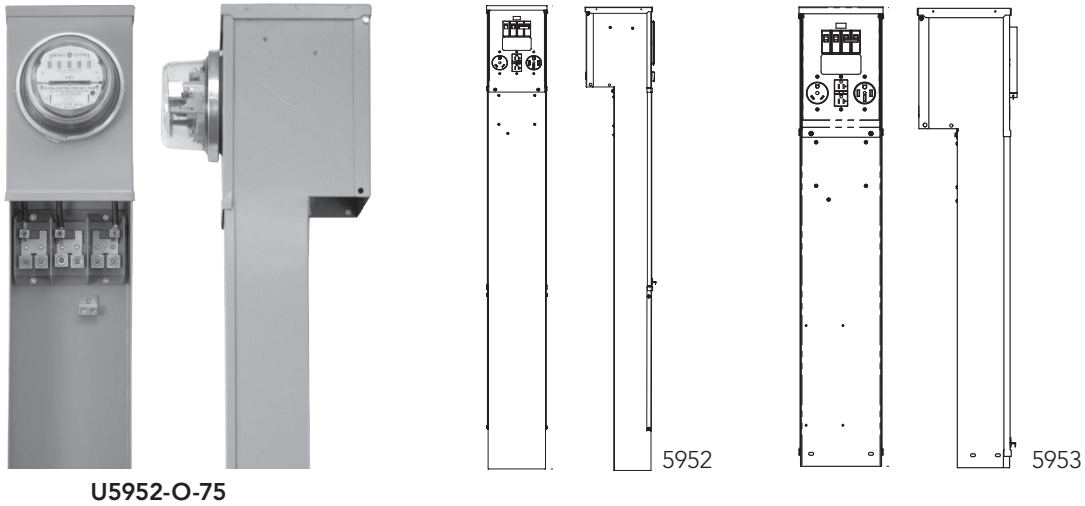

100 Amps | Metered | Ringless

Catalog Number	Mounting Type	Receptacle Configuration	Circuit Breaker Configuration	Dimensions		
				D"	W"	H"
U5952-XL-41	Direct Burial	A	X	5 $\frac{1}{8}$	8	70
U5952-XL-55	Direct Burial	B	Y	5 $\frac{1}{8}$	8	70
U5952-XL-75	Direct Burial	C	Z	5 $\frac{1}{8}$	8	70
U5953-O-41	Pad-Mount	A	X	5 $\frac{3}{16}$	8	46
U5953-O-55	Pad-Mount	B	Y	5 $\frac{3}{16}$	8	46
U5953-O-75	Pad-Mount	C	Z	5 $\frac{3}{16}$	8	46

Receptacle Configurations

A	B	C
(1) TT30R, (1) 5-20R GFI	(1) 14-50R, (1) 5-20R GFI	(1) 14-50R, (1) TT30R, (1) 5-20R GFI

Circuit Breaker Configurations

X	Y	Z
(1) 30A, 1P, 120V (1) 20A, 1P, 120V	(1) 50A, 2P, 120/240V (1) 20A, 1P, 120V	(1) 50A, 2P, 120/240V (1) 30A, 1P, 120V (1) 20A, 1P, 120V

Note

Contact factory for additional configurations not shown here.









Please consult serving utility for their requirements prior to ordering or installing, as specifications and approvals vary by utility, and may require local electrical inspector approval. All installations must be installed by a licensed electrician and must comply with all national and local codes, laws and regulations. Milbank reserves the right to make changes in specifications and features shown without notice or obligation.

Replacement Parts and Accessories

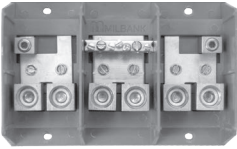

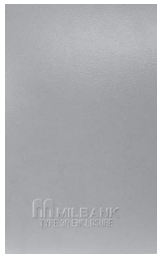
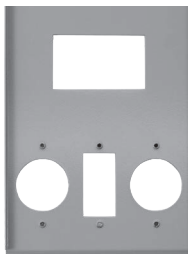

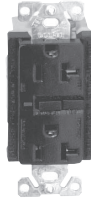
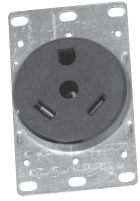
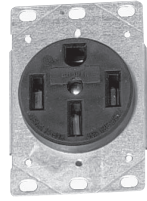
67

For Voyager Series RV Products

		
<p>Q120 20 Amps, one-pole circuit breaker</p>	<p>Q130 30 Amps, one-pole circuit breaker</p>	<p>Q250 50 Amps, two-pole circuit breaker</p>
		
<p>Z1144618 (unmetered) Z1147928 (metered) Lug landing base</p>	<p>Z1050761 Circuit breaker base</p>	<p>Z915141-AC Left or right meter block assembly</p>
		
<p>Z1144586 Hinge cover</p>	<p>Z1144587 (-75, shown) Z1144921 (-41) Z1144946 (-55) Deadfront</p>	<p>MR-2 Snap action sealing ring</p>
		
<p>Z708080-MO 20 Amps GFI receptacle NEMA 5-20GR</p>	<p>Z701776-MO 30 Amps receptacle NEMA TT-30</p>	<p>Z708767-MO 50 Amps receptacle NEMA 14-50R</p>

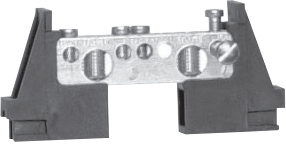
Please consult serving utility for their requirements prior to ordering or installing, as specifications and approvals vary by utility, and may require local electrical inspector approval. All installations must be installed by a licensed electrician and must comply with all national and local codes, laws and regulations. Milbank reserves the right to make changes in specifications and features shown without notice or obligation.

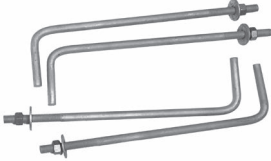
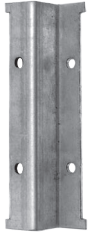
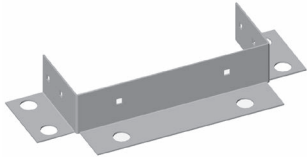

		
<p>Neutral assembly shown with 2 insulator supports (Z1002682) and 1 ground connector (Z1002769) for metered version</p>	<p>Z1002769 Ground assembly for unmetered version</p>	<p>K5421 Anchor bolt kit</p>
		
<p>Z1144588 Circuit breaker bracket</p>	<p>K5960 - Metered pedestal K5959 - Unmetered pedestal Field-installed pad-mount kit</p>	<p>K5415 Stabilizer foot with hardware</p>
		
<p>CL200D EZ read watt-hour meter</p>		



Please consult serving utility for their requirements prior to ordering or installing, as specifications and approvals vary by utility, and may require local electrical inspector approval. All installations must be installed by a licensed electrician and must comply with all national and local codes, laws and regulations. Milbank reserves the right to make changes in specifications and features shown without notice or obligation.

Surface-Mount Power Outlets

Millennium Series | Metered and Unmetered | 120/240V



U5000-XL-75

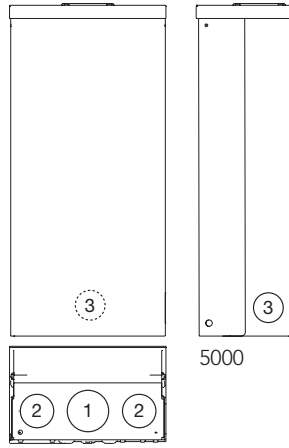

5000



U5100-XL-75

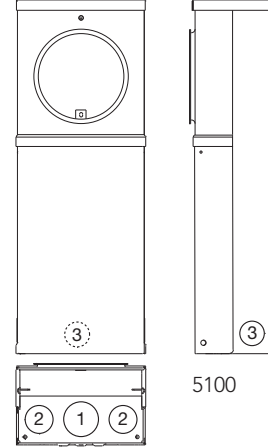

5100

125 Amps

Catalog Number	Metered/ Unmetered	Receptacle Configuration	Circuit Breaker Configuration	Loop Feed	Connectors - Line	Dimensions			Knockouts		
						D"	W"	H"	1	2	3
U5000-XL	Unmetered	—	—	Yes	(2) 1/0-#12	5½	9⅞	19¼	2	1½	1¼
U5000-XL-41	Unmetered	A	X	Yes	(2) 1/0-#12	5½	9⅞	19¼	2	1½	1¼
U5000-XL-55	Unmetered	B	Y	Yes	(2) 1/0-#12	5½	9⅞	19¼	2	1½	1¼
U5000-XL-75	Unmetered	C	Z	Yes	(2) 1/0-#12	5½	9⅞	19¼	2	1½	1¼
U5100-XL	Metered	—	—	No	#6-250	5½	9⅞	25	2	1½	1¼
U5100-XL-41	Metered	A	X	No	#6-250	5½	9⅞	25	2	1½	1¼
U5100-XL-55	Metered	B	Y	No	#6-250	5½	9⅞	25	2	1½	1¼
U5100-XL-75	Metered	C	Z	No	#6-250	5½	9⅞	25	2	1½	1¼

Receptacle Configurations

A	B	C
(1) TT30R, (1) 5-20R GFI	(1) 14-50R, (1) 5-20R GFI	(1) 14-50R, (1) TT30R, (1) 5-20R GFI

Circuit Breaker Configurations

X	Y	Z
(1) 30A, 1P, 120V (1) 20A, 1P, 120V	(1) 50A, 2P, 120/240V (1) 20A, 1P, 120V	(1) 50A, 2P, 120/240V, (1) 30A, 1P, 120V (1) 20A, 1P, 120V

Note

Contact factory for additional configurations not shown here.

Please consult serving utility for their requirements prior to ordering or installing, as specifications and approvals vary by utility, and may require local electrical inspector approval. All installations must be installed by a licensed electrician and must comply with all national and local codes, laws and regulations. Milbank reserves the right to make changes in specifications and features shown without notice or obligation.





U5200-XL-75

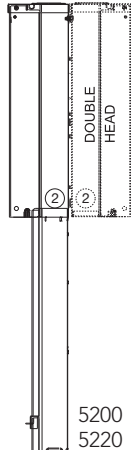
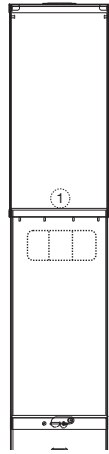

U5300-O-75

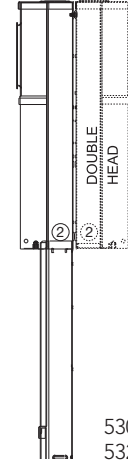
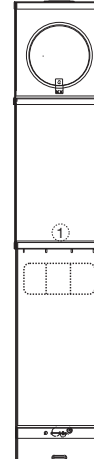

125 Amps | Direct Bury

Catalog Number	Double Head Catalog Number	Metered/ Unmetered	Receptacle Configuration	Circuit Breaker Configuration	Dimensions			Knockouts
					D"	W"	H"	1
U5200-XL	U5220-XL	Unmetered	—	—	5 ⁵ / ₁₆	9 ⁷ / ₈	64 ¹ / ₂	1 ¹ / ₄
U5200-XL-41	U5220-XL-41	Unmetered	A	X	5 ⁵ / ₁₆	9 ⁷ / ₈	64 ¹ / ₂	1 ¹ / ₄
U5200-XL-55	U5220-XL-55	Unmetered	B	Y	5 ⁵ / ₁₆	9 ⁷ / ₈	64 ¹ / ₂	1 ¹ / ₄
U5200-XL-75	U5220-XL-75	Unmetered	C	Z	5 ⁵ / ₁₆	9 ⁷ / ₈	64 ¹ / ₂	1 ¹ / ₄
U5300-O	U5320-O	Metered	—	—	5 ⁵ / ₁₆	9 ⁷ / ₈	70 ¹ / ₄	1 ¹ / ₄
U5300-O-41	U5320-O-41	Metered	A	X	5 ⁵ / ₁₆	9 ⁷ / ₈	70 ¹ / ₄	1 ¹ / ₄
U5300-O-55	U5320-O-55	Metered	B	Y	5 ⁵ / ₁₆	9 ⁷ / ₈	70 ¹ / ₄	1 ¹ / ₄
U5300-O-75	U5320-O-75	Metered	C	Z	5 ⁵ / ₁₆	9 ⁷ / ₈	70 ¹ / ₄	1 ¹ / ₄

Receptacle Configurations

A	B	C
(1) TT30R, (1) 5-20R GFI	(1) 14-50R, (1) 5-20R GFI	(1) 14-50R, (1) TT30R, (1) 5-20R GFI

Circuit Breaker Configurations

X	Y	Z
(1) 30A, 1P, 120V (1) 20A, 1P, 120V	(1) 50A, 2P, 120/240V (1) 20A, 1P, 120V	(1) 50A, 2P, 120/240V, (1) 30A, 1P, 120V (1) 20A, 1P, 120V

Note





Contact factory for additional configurations not shown here. Pad-mount is available — contact factory for information.

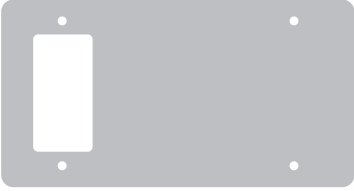

Please consult serving utility for their requirements prior to ordering or installing, as specifications and approvals vary by utility, and may require local electrical inspector approval. All installations must be installed by a licensed electrician and must comply with all national and local codes, laws and regulations. Milbank reserves the right to make changes in specifications and features shown without notice or obligation.

Replacement Receptacle Plates

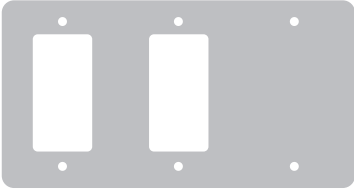
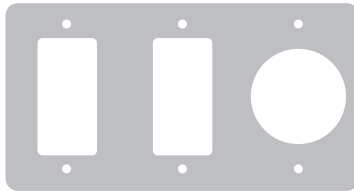
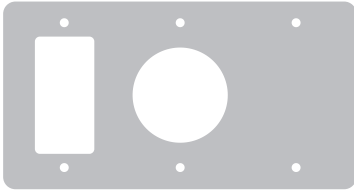
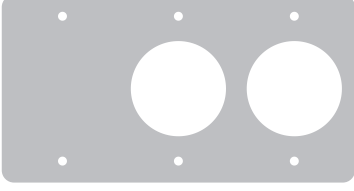
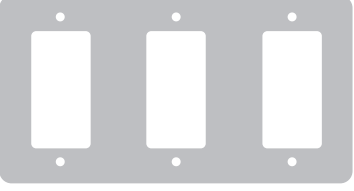
For Millennium Series RV Products

		
K5920-75	K5920-10GR	K5920-54
		
K5920-11GR	K5920-522	K5920-41
		
K5920-58	K5920-111GR	K5920-BLANK
		
K5920-38		

Notes

- For application details, consult factory.

Please consult serving utility for their requirements prior to ordering or installing, as specifications and approvals vary by utility, and may require local electrical inspector approval. All installations must be installed by a licensed electrician and must comply with all national and local codes, laws and regulations. Milbank reserves the right to make changes in specifications and features shown without notice or obligation.



Internal Light Kits for Unmetered Power Outlets (U5000 and U5200)

Application	Internal light kit for unmetered power outlets	
Features	Includes 5-watt fluorescent Amps socket, ballast, Amps shield and opaque hinge cover lens. Factory wired to 20 Amps GFI circuit. May be wired to separate 20 Amps circuit breaker. Order Q120 separately. Cover on unmetered power outlet is 19 1/8" in height.	
Ordering	Order with -L suffix (after catalog number) for factory-installed. Order catalog number K5411 for field-installed.	

Internal Light Kits for Metered Power Outlets (U5100 and U5300)

Application	Internal light kit for metered power outlets	
Features	Includes 5-watt fluorescent Amps socket, ballast, Amps shield and opaque hinge cover lens. Factory wired to 20 Amps GFI circuit. May be wired to separate 20 Amps circuit breaker. Order Q120 separately. Cover on unmetered power outlet is 15 1/4" in height.	
Ordering	Order with -L suffix (after catalog number) for factory-installed. Order catalog number K5412 for field-installed.	

Photoelectric Light Control Kit

Application	Photoelectric light control kit for K5411 and K5412 light kit	
Features	2.5 Amps, 120V photo electric control wired in series with K5411 and K5412 light kits.	
Ordering	Order with -LPC suffix for factory-installed light and PE control. Order catalog number K5413 for field-installed.	



Please consult serving utility for their requirements prior to ordering or installing, as specifications and approvals vary by utility, and may require local electrical inspector approval. All installations must be installed by a licensed electrician and must comply with all national and local codes, laws and regulations. Milbank reserves the right to make changes in specifications and features shown without notice or obligation.

Telecom and Pedestal Accessories

For Millennium Series RV Products

Telephone and Cable TV Kit

Application	Mounts to rear of pedestal series U5200 and U5300 . May also be adaptable to a wooden or similar structure.	
Features	<p>Single: 16" galvanized raceway, (1) RJ11 telephone jack and (1) Type F coaxial CATV jack.</p> <p>Dual: 16" galvanized raceway, (2) RJ11 telephone jacks and (1) Type F coaxial CATV jack.</p> <p>Includes mounting hardware and instructions.</p>	
Ordering	Single line telephone and cable TV kit order K4709-02 .	
Note	Confirm acceptability with cable TV and telephone provider before ordering or installing these devices.	

K4709-02-3R

K4709-02

Water Shroud with Hardware

Application	Used to cover water pipe and provide means to mount hose bib to rear of pedestal.	
Features	<p>Includes mounting hardware and instructions.</p> <p>Matches K4709 kits when mounted side by side.</p>	
Ordering	Order catalog number K4709-WS .	

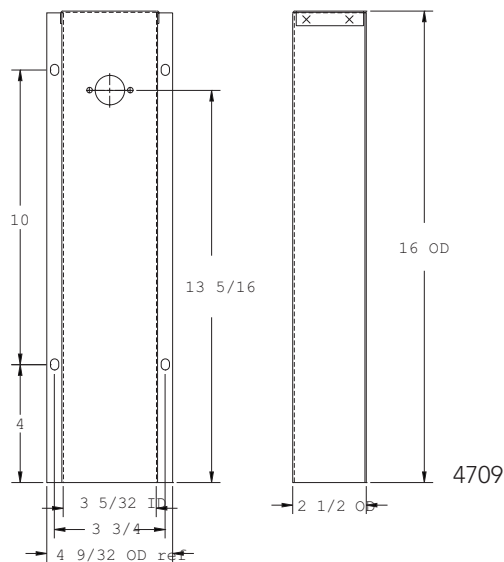

Please consult serving utility for their requirements prior to ordering or installing, as specifications and approvals vary by utility, and may require local electrical inspector approval. All installations must be installed by a licensed electrician and must comply with all national and local codes, laws and regulations. Milbank reserves the right to make changes in specifications and features shown without notice or obligation.

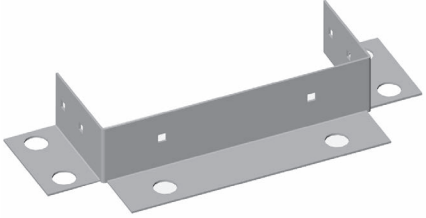

Field-installable Pad-mount Kit

Application	Field-installable pad-mount kit with (6) ¾" mounting holes.	
Features	Includes ¼-20 stainless steel hardware to attach pad-mount base to post. Anchor bolt kit sold separately (order catalog number K5421).	
Ordering	Order catalog number K5410 .	

Stabilizer Foot with Hardware

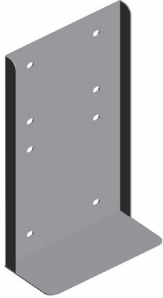
Application	Stabilizes direct burial type posts in unstable soil conditions.	
Features	Includes ¼-20 hardware to attach to U5200 and U5300 pedestals.	
Ordering	Order catalog number K5415 .	

Anchor Bolt Kit

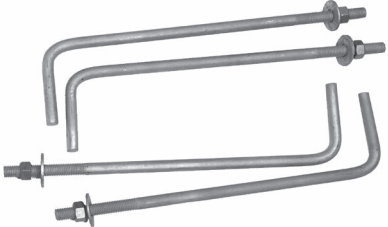
Application	Concrete anchor bolt kit designed to attach pad-mount base to concrete.	
Features	(4) sets of zinc-plated 5/8-11 x 10" bolt with 2" toe. Includes nut and flat washer.	
Ordering	Order catalog number K5421 .	



Please consult serving utility for their requirements prior to ordering or installing, as specifications and approvals vary by utility, and may require local electrical inspector approval. All installations must be installed by a licensed electrician and must comply with all national and local codes, laws and regulations. Milbank reserves the right to make changes in specifications and features shown without notice or obligation.

Metering and Receptacle Accessories

For Millennium Series RV Products





Field-installable Meter Kits

Application	Field-installable meter kit for U5000 and U5200 power outlets.	
Features	100 Amps cast meter socket, CL200 E-Z Read Meter, sealing ring, security seal, 1" Milbank hub, nipple and mounting screws. See CL200-D for watt-hour meter specification.	
Ordering	Order catalog number K4800-D .	

E-Z Read Watt-hour Meter







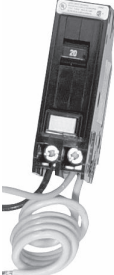

Application	200 Amps E-Z read watt-hour meter designed to be field-installable on the U5100 and U5300 metered power outlets.	
Features	200 Amps form 2S 120/240V. Numeric readout in full kilowatt increments. No "tenths" dial. Remanufactured to 1% accuracy.	
Ordering	Order catalog number CL200-D .	

Single Receptacle Only Power Outlet

Application	Overhead/underground power outlet receptacle, suitable for RV, temporary service, campground, marina and boatyard equipment.			
Features	NEMA 3R, 120/240V single phase. Lockable cover.			
Ordering	Order catalog number from options below.			
Receptacle Options	 P-10GWR 20A 5-20GR 120V GFI	 P-13 30A TT-30R 120V	 P-54 50A 14-50R 120/240V	

Please consult serving utility for their requirements prior to ordering or installing, as specifications and approvals vary by utility, and may require local electrical inspector approval. All installations must be installed by a licensed electrician and must comply with all national and local codes, laws and regulations. Milbank reserves the right to make changes in specifications and features shown without notice or obligation.

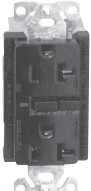
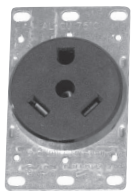
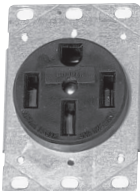

			
<p>Q120 20 Amps, one-pole circuit breaker</p>	<p>708784-MO 20 Amps, one-pole GFI circuit breaker</p>	<p>Q130 30 Amps, one-pole circuit breaker</p>	<p>Q250 50 Amps, two-pole circuit breaker</p>
			
<p>Z918466-AC Lug landing base</p>	<p>Z917602-AC Circuit breaker base (6 circuit)</p>	<p>Z915141-AC Left or right meter block assembly</p>	
			
<p>Z918449-AC (19" unmetered) Z918447-AC (15" metered) Hinge cover</p>	<p>Z818052-SC (19" unmetered) Z818480-SC (15" metered) Deadfront</p>	<p>MR-2 Snap action sealing ring</p>	
			
<p>Z708080-MO 20 Amps GFI receptacle NEMA 5-20GR</p>	<p>Z701776-MO 30 Amps receptacle NEMA TT-30</p>	<p>Z708767-MO 50 Amps receptacle NEMA 14-50R</p>	

Terminal Boxes

100, 200 and 400 Amps | 600V



U4540-XL

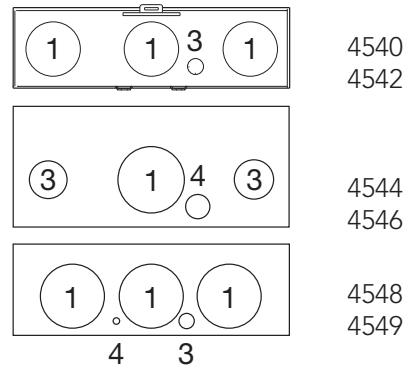
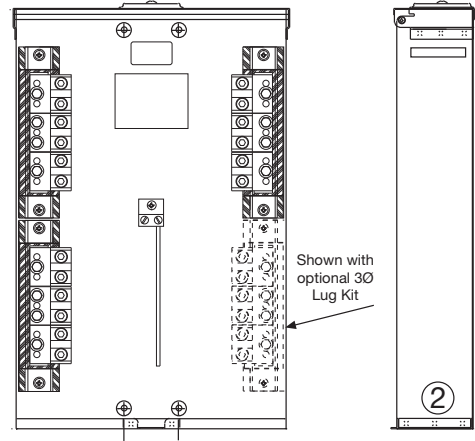

Terminal Boxes | 1Ø and 3Ø | 600V

Catalog Number	Amps	Phase	Hub	Connectors CU/AL	1Ø to 3Ø Kit	Dimensions			Knockouts			
						D"	W"	H"	1	2	3	4
U4544-XL	100	1	C.P.	(6) #12-1/0	K4543	4 ¹ / ₈	9 ¹³ / ₁₆	18	2	1	¼, ½	—
U4546-XL	100	3	C.P.	(6) #12-1/0	N/A	4 ¹ / ₈	9 ¹³ / ₁₆	18	2	1	¼, ½	—
U4540-XL	200	1	C.P.	(6) #6-350	K4539	4 ¹ / ₈	14 ¹³ / ₁₆	23	2½	2½	1¼	¼, ½
U4542-XL	200	3	C.P.	(6) #6-350	N/A	4 ¹ / ₈	14 ¹³ / ₁₆	23	2½	2½	1¼	¼, ½
U4548-RXL	400	1	C.P.	(3) #6-350 or (2) #4-600	K4547	5	15½	27	3	3	¼, ½	¼
U4549-RXL	400	3	C.P.	(3) #6-350 or (2) #4-600	N/A	5	15½	27	3	3	¼, ½	¼

Notes

- Hubs: For proper hub selection, see the hub suffix chart on the accessories page.
- Features: UL-Listed padlockable NEMA 3R enclosure.
- **3Ø Application:** Field-installable 3Ø lug kit converts 1Ø unit to 3Ø unit.

Please consult serving utility for their requirements prior to ordering or installing, as specifications and approvals vary by utility, and may require local electrical inspector approval. All installations must be installed by a licensed electrician and must comply with all national and local codes, laws and regulations. Milbank reserves the right to make changes in specifications and features shown without notice or obligation.



Milbank enclosed controls are an alternative to unsightly and inefficient strut and backboard structures. Enclosed controls are an attractive, secure, easy-to-install and cost-effective solution for underground remote site power distribution. Cabinets are weather-resistant enclosures that can be crafted to suit any environment with various mounting options. Each individual unit features a utility pull section with an optional meter socket and a separate customer section with distribution and control equipment.



Strut and Backboard



Commercial Pedestal

UL-Listed as Industrial Control Equipment (File E113855)

Standard Features

- NEMA 3R rain-resistant, vandal-resistant cabinet of polyurethane powder coated steel (aluminum or stainless steel also available).
- UL-listed as enclosed industrial control equipment (UL508A).
- Isolated lockable and sealable utility metering and lug landing sections.
- Lockable customer section for distribution and control equipment with internal deadfront.
- Print pocket inside customer section door contains wiring schematics and installation instructions.
- Load centers are UL-listed for use with various manufacturers' circuit breakers.
- All stainless steel external hardware (screws, bolts, hinges, handles, hasps and sealing screws).

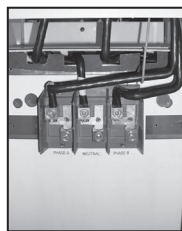

Please consult serving utility for their requirements prior to ordering or installing, as specifications and approvals vary by utility, and may require local electrical inspector approval. All installations must be installed by a licensed electrician and must comply with all national and local codes, laws and regulations. Milbank reserves the right to make changes in specifications and features shown without notice or obligation.

Enclosed Controls

Attractive | Easy-to-Install | Secure | Cost-Effective



Applications

These units are ideal for controlling and metering:

- Traffic signals and street lighting for municipalities.
- Power distribution for electric vehicle charging stations.
- Communication equipment such as cell towers and telephone vaults.
- Event power for fairgrounds, outdoor markets, portable offices, holiday lights, etc.
- Outdoor lighting for athletic fields, tennis and basketball courts, parking lots, landscaping and subdivision entrances.

Available Factory-Installed Options

- Meter sockets: ring type or ringless, up to 400 Amps
- Main and branch breakers or T fuses
- Distribution: copper load centers and panelboards
- Clocks, timers and relays
- Photoelectric cells and controls
- Various power receptacles: pin and sleeve, twist lock or straight blade
- Contactors: lighting, definite purpose, motor starters
- Surge protection and lightning arresters
- Generator inlets with interlocked breakers
- Push button controls
- Thermostat controls, fans and heating strips
- Power blocks and Terminals blocks
- Steel, aluminum and plywood backboards
- Transformers
- Interlock devices for circuit breakers

Options

- Available in steel, aluminum (raw painted or anodized) or stainless steel construction with powder coated finish available in eight standard colors or special-ordered RAL colors.
- Available for applications up to 400 Amps, 120V, 208V, 240V, 277V, 480V - 1Ø or 3Ø.

Accessories

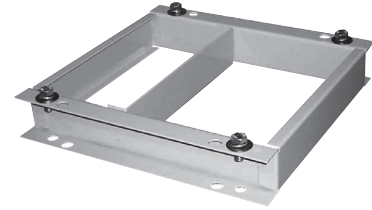

Pad-mount bases available for all pedestal sizes, inquire with your representative for details.

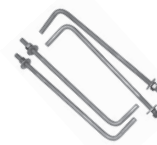

CP-ABK5/8

Anchor bolt kit
(includes four 5/8 - 13 x 18" anchor bolts)



105J

Fifth Terminals kit for use with ring type meter sockets



K3865

Fifth Terminals kit for use with ringless meter sockets



CP-TC7D

7-day time clock kit

CP-TC24H

24-hour time clock kit

CP-TCWIRE

Male 4-pin connector and wiring harness for use with time clocks other than above



CP-PE-HOA-3POS

HOA switch for field installation

Please consult serving utility for their requirements prior to ordering or installing, as specifications and approvals vary by utility, and may require local electrical inspector approval. All installations must be installed by a licensed electrician and must comply with all national and local codes, laws and regulations. Milbank reserves the right to make changes in specifications and features shown without notice or obligation.



Application: Remote site service for multiple loads

Milbank Main Load Center Commercial Pedestals are designed to handle the vast majority of all requirements in a standard, stocked configuration.

- All units feature a load center with a plug-on, back-fed main breaker.
- Standard units are equipped with with a 16 circuit load center in the 100 Amps or 24 circuit load center in 200 Amps models.
- Sub-feed lugs to allow feeding an external panel.

If your application requires turning loads on based on “dusk-to-dawn” requirements, be sure to see the Milbank Switched Load Center Commercial Pedestal products on the following page.

Features

These units include everything required for remote site service:

- Expandable: load centers allow for future expansion without costly modifications.
- All units feature a 200 Amps meter socket with optional field-installable fifth Terminals kit available.
- 22K Amps interrupting capacity (AIC) standard.
- Optional mounting base can be embedded in concrete for fast, easy installation.
- Separate sealable and lockable utility termination section.
- Separate sealable and lockable metering section.
- Separate sealable and lockable customer section with a load center for “always on” loads that include a main circuit breaker, 20 (125 or 200 Amps model) or 14 (100 Amps model) blank breaker spaces and a circuit directory to document configuration.



Please consult serving utility for their requirements prior to ordering or installing, as specifications and approvals vary by utility, and may require local electrical inspector approval. All installations must be installed by a licensed electrician and must comply with all national and local codes, laws and regulations. Milbank reserves the right to make changes in specifications and features shown without notice or obligation.

Enclosed Controls

Switched Load Center Commercial Pedestals

Switched Load Center Commercial Pedestals

1Ø3-wire 120/240V or 208Y/120V

Designed not only to provide power for various loads, but also to switch specific loads on and off under certain conditions. A photoelectric cell is used for these controlled loads, and an optional time clock is also available.

Features

These units include everything required for remote site service:

- Expandable: load centers allow for future expansion without costly modifications.
- All units feature a 200 Amps meter socket with optional field-installable fifth Terminals kit available.
- 22K Amps interrupting capacity (AIC) standard.
- Optional mounting base can be embedded in concrete for fast, easy installation.
- Separate sealable and lockable utility termination section.
- Separate sealable and lockable metering section.
- Separate sealable and lockable customer section with a control circuit including PE receptacle, Lexan® window, glare shield, Hand-Off-Auto (HOA) switch, contractor controlling a 16-circuit load center for controlled loads, a pre-mounted DIN rail and pre-wired connector to add an optional "plug-and-play" time clock kit for PE on and TC off operation and a circuit directory to document configuration.
- A load center for "always on" loads that includes a main circuit breaker, a control power circuit breaker, a switched load center main breaker, nine (125 or 200 Amps model) or 11 (100 Amps model) blank breaker spaces and a circuit directory to document configuration.



Ringless Lever Bypass shown

Applications



Traffic Signals



Parking Lots



Highways



Athletic Field Lighting

Please consult serving utility for their requirements prior to ordering or installing, as specifications and approvals vary by utility, and may require local electrical inspector approval. All installations must be installed by a licensed electrician and must comply with all national and local codes, laws and regulations. Milbank reserves the right to make changes in specifications and features shown without notice or obligation.



Enclosed Controls

400 Amps Commercial Pedestals



Designed to provide a weather- and vandal-resistant metered enclosure for various loads and distribution. Each pedestal has been designed to handle a wide range of applications using standard, stocked configurations including:

- Choice of a single main breaker or twin service disconnect breakers gives flexibility to the pedestal design.
- Optional distribution with feed-through lugs below the service disconnect breakers allows the pedestal to handle numerous applications.
- Typical applications include remote homes where the metering is best located at the curb side or other remote area. The pedestal can also provide power to a secondary residence, on-site business, workshop, irrigation, lighting, security or other secondary load.

Features

These units include everything required for remote service:

- Main circuit breaker or dual service disconnects.
- Expandable: load center units that allow for future expansion without costly modifications.
- Optional mounting base can be embedded in concrete for fast, easy installation.
- Separate sealable and lockable utility termination section with lug termination.
- Separate sealable and lockable metering section.
- Separate sealable and lockable customer section with a circuit directory and a print pocket to hold all documentation.
- Meter socket options include ring type with bypass studs, ringless with heavy duty lever bypass, or K-type bolt-on.

Applications



Commercial Job Sites



Remote Site for
Residential and
Commercial Job Sites



Please consult serving utility for their requirements prior to ordering or installing, as specifications and approvals vary by utility, and may require local electrical inspector approval. All installations must be installed by a licensed electrician and must comply with all national and local codes, laws and regulations. Milbank reserves the right to make changes in specifications and features shown without notice or obligation.

Surface-Mount Enclosed Controls

Originally developed for small cellular communications, the surfacemount enclosed control offers the flexibility of larger enclosed controls products with a smaller footprint and several mounting options.

Features

- Mounting options allow for easy installation.
- Overhead and underground entry and exit, all in one unit.
- Meter and components in one enclosure.
- Custom component configurations and UL-listing covers all internal components on the UL508A and UL891.
- Can be mounted on multiple surfaces including:
 - walls.
 - poles (narrow profile will have minimal extension past sides).
 - H frames (strut).
- Multiple bypass options available.
- Monitoring options available.
- Optional powder coating in Milbank standard EC color or custom color.



Benefits

- Smaller footprint
- Flood resistant
- Eliminates need for connecting components
 - Wire in - Wire Out

Applications



Communications
Power Distribution



Lighting
Control

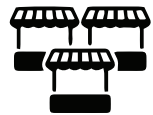

Streetscape
Power Distribution

Please consult serving utility for their requirements prior to ordering or installing, as specifications and approvals vary by utility, and may require local electrical inspector approval. All installations must be installed by a licensed electrician and must comply with all national and local codes, laws and regulations. Milbank reserves the right to make changes in specifications and features shown without notice or obligation.





Power transfer commercial pedestals provide metered or unmetered AC power, distribution, surge suppression, mechanical interlock and standby generator receptacles — in one compact pedestal.

Features

- 120/240V 1Ø3W through 277/480V 3Ø4W ratings
- Metered or unmetered units
- Choice of EUSERC ring type or ringless meter sockets
- 60 Amps through 400 Amps ratings
- Pad-lockable, isolated utility compartments
- 20 Amps GFCI convenience receptacle
- Lockable recessed generator receptacle door
- Utility and generator indicator light options
- All stainless steel hardware
- Galvanized steel, aluminum or stainless steel cabinet options
- Custom designs available

Note

- May require customization based on regional requirements.



Applications



Traffic Signals



Pump and Lift Stations



Communications Power Distribution



Please consult serving utility for their requirements prior to ordering or installing, as specifications and approvals vary by utility, and may require local electrical inspector approval. All installations must be installed by a licensed electrician and must comply with all national and local codes, laws and regulations. Milbank reserves the right to make changes in specifications and features shown without notice or obligation.

Enclosed Controls

CT Metered Commercial Pedestals



Designed to be used where a smaller service package would be a better choice over larger switchgear equipment. These pedestals have amperage ratings of 400 to 800 Amps at voltages up through 480V three phase.

Features

- Available configurations up to 800 Amps.
- All utility equipment is isolated in separate padlockable and sealable compartments.
- Separate customer compartment designed to hold distribution and control equipment.
- Deadfront customer construction for enhanced safety measures.
- A mounting base option for various applications.
- Optional construction in steel, aluminum and stainless steel.

Note

- May require customization based on regional requirements.

Applications



Commercial and Industrial Control Systems



Pump and Lift Stations



Water Treatment Plants

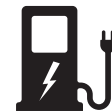

Electric Vehicle Charging Stations

Please consult serving utility for their requirements prior to ordering or installing, as specifications and approvals vary by utility, and may require local electrical inspector approval. All installations must be installed by a licensed electrician and must comply with all national and local codes, laws and regulations. Milbank reserves the right to make changes in specifications and features shown without notice or obligation.



Enclosed Controls

Slimline Commercial Pedestals



Provides a sleeker, smaller footprint with wireway access on the side of the unit, rather than the back. This allows maximum flexibility to install the pedestal anywhere physical space is at a premium.

Providing unmetered AC power, distribution, surge suppression, mechanical interlock and standby generator receptacle — all in a neat, compact pedestal.

Features

- Available for 100 or 200 Amps.
- Vandal-resistant, secure and attractive design.
- Customer compartment with distribution and control equipment with swing deadfront door, secured with both a hasp/latch and draw latch outer door.
- Utility metering compartment protected with a hinged hood, increasing resistance to meter vandalism.
- Slim design creates a smaller footprint.
- Wireway located on left side of pedestal for utility incoming wire, allowing pedestal to be mounted with back as close as 14" to walls or structures.
- Available in 12" and 20" widths and 50" and 63" (metered) and 43" (unmetered) heights. Includes a print pocket for plans and drawings.
- Voltage range is between 120V and 480V.
- Compatible with both ringless and ring type meter sockets, 4–7 terminals.
- Available in a wide array of colors, including but not limited to all ANSI powder coated paint colors upon request.
- Pedestal mounting base option saves time and labor to install on a cement pad—no anchor bolts required.
- Powder coated G90 galvanized steel or aluminum; raw, anodized or powder coated, as well as stainless steel exterior options.



With no need to coordinate, buy or wait for concrete, **direct bury pedestals** offer many advantages and can cut installation time down to less than an hour. Traditional direct bury pedestals can be awkward to transport and can only be used in a direct bury application. Milbank's modular design offers flexibility and convenience for distributors and contractors alike.



Notes

- May require customization based on regional requirements.
- Direct bury pedestals are only available for 12" pedestals. Constructed with 14-gauge steel.



Please consult serving utility for their requirements prior to ordering or installing, as specifications and approvals vary by utility, and may require local electrical inspector approval. All installations must be installed by a licensed electrician and must comply with all national and local codes, laws and regulations. Milbank reserves the right to make changes in specifications and features shown without notice or obligation.

Circuit Breakers

UQFP Plug-In Series and UQFB Bolt-On Series

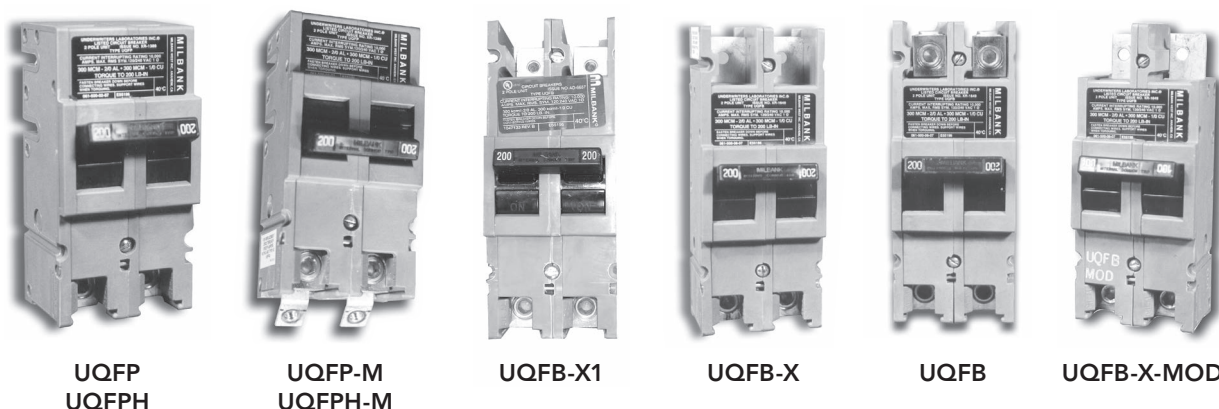

200 Amps Frame | Plug-In | 10K AIC and 22K AIC | Two-Pole - Common Trip

Amps	10K AIC Plug-In	22K AIC Plug-In	10K AIC Plug-In	22K AIC Plug-In	Wire Range	
					CU	AL
100	UQFP-100	UQFPH-100	UQFP-M-100	UQFPH-M-100	#3-#1	#1-1/0
125	UQFP-125	UQFPH-125	UQFP-M-125	UQFPH-M-125	#3-#1	#1-1/0
150	UQFP-150	UQFPH-150	UQFP-M-150	UQFPH-M-150	1/0-300	2/0-300
175	UQFP-175	UQFPH-175	UQFP-M-175	UQFPH-M-175	1/0-300	2/0-300
200	UQFP-200	UQFPH-200	UQFP-M-200	UQFPH-M-200	1/0-300	2/0-300

200 Amps Frame | Bolt-On | 10K AIC and 22K AIC | Two-Pole - Common Trip

Amps	10K AIC Bolt-On	22K AIC Bolt-On	10K AIC Bolt-On	22K AIC Bolt-On	Wire Range	
					CU	AL
100	UQFB-100	UQFBH-100	UQFB-100-X1	UQFBH-M-100	#3-#1	#1-1/0
125	UQFB-125	UQFBH-125	UQFB-125-X1	UQFBH-M-125	#3-#1	#1-1/0
150	UQFB-150	UQFBH-150	UQFB-150-X1	UQFBH-M-150	1/0-300	2/0-300
175	UQFB-175	UQFBH-175	UQFB-175-X1	UQFBH-M-175	1/0-300	2/0-300
200	UQFB-200	UQFBH-200	UQFB-200-X1	UQFBH-M-200	1/0-300	2/0-300

Notes

- **UL-Listed:** For use with 60°C or 75°C wire.
- **UQFP:** For parallel main circuit breaker applications.
- **UQFP-M:** For series main circuit breaker applications. Split load tab features allow for feed-through capability.
- **UQFB:** (2) 1/0-300 lugs provided on load and line side (cable-in, cable-out).
- **UQFB3:** Three-pole available. Consult factory.
- **UQFB-X:** (2) 1/0-300 lugs provided on load side and (2) line bar bus connections on line side.
- **UQFB-M:** For series main circuit breaker applications. Split load tab features allow for feed-through capability.
- **UQFB-X-MOD:** Replacement circuit breaker with line barriers removed.

Please consult serving utility for their requirements prior to ordering or installing, as specifications and approvals vary by utility, and may require local electrical inspector approval. All installations must be installed by a licensed electrician and must comply with all national and local codes, laws and regulations. Milbank reserves the right to make changes in specifications and features shown without notice or obligation.



**15–125 Amps Breaker
Plug-In Type | 1" Per Pole**

Amps	Poles	10K AIC Plug-In	22K AIC Plug-In
15	Single	Q115	Q115H
15	Double	Q215	Q215H
20	Single	Q120	Q120H
20	Double	Q220	Q220H
25	Single	Q125	Q125H
25	Double	Q225	Q225H
30	Single	Q130	Q130H
30	Double	Q230	Q230H
35	Single	Q135	Q135H
35	Double	Q235	Q235H
40	Single	Q140	Q140H
40	Double	Q240	Q240H
50	Single	Q150	Q150H
50	Double	Q250	Q250H
60	Single	Q160	Q160H
60	Double	Q260	Q260H
70	Single	Q170	Q170H
70	Double	Q270	Q270H
80	Double	Q280	Q280H
90	Double	Q290	Q290H
100	Double	Q2100	Q2100H
125	Double	Q2125	Q2125H



QN2200H



QN2200RH



WBJ2200



Q250

200 Amps Frame | Plug-In | 10K AIC and 22K AIC | two-pole, Common Trip

Amps	10K AIC Plug-In	22K AIC Plug-In	Handle Location	Wire Range	
				CU	AL
150	QN2150	QN2150H	Left facing	#4-300	#4-300
200	QN2200	QN2200H	Left facing	#4-300	#4-300
150	QN2150R	QN2150RH	Right facing	#4-300	#4-300
200	QN2200R	QN2200RH	Right facing	#4-300	#4-300
150	WBJ2150	—	Centered	#2-300	#2-300
200	WBJ2200	—	Centered	#2-300	#2-300

Notes

- Load connectors supplied with breakers.
- UL-Listed for use with 60°C or 75°C wire.
- Wire sizes shown are lug capacity. Consult NEC Article #310 for specific wire sizes.







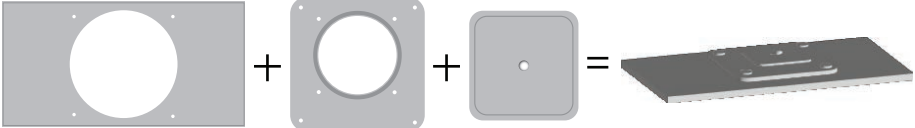

Please consult serving utility for their requirements prior to ordering or installing, as specifications and approvals vary by utility, and may require local electrical inspector approval. All installations must be installed by a licensed electrician and must comply with all national and local codes, laws and regulations. Milbank reserves the right to make changes in specifications and features shown without notice or obligation.

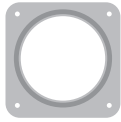

Accessories

Hubs and Closing Plates

	
-RL	-RXL
Small hub opening	Large hub opening + Adapter plate + Small closing plate

					
-WL A7514	-YL A7515	-ZL A7516	-DL A7517	-EL A7518	-XL A7551
1" hub	1¼" hub	1½" hub	2" hub	2½" hub	Small closing plate

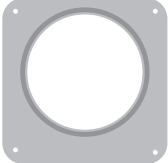
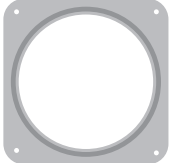
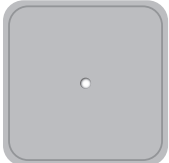
-R
Large hub opening

				
-F A8110	-G A8111	H A8112	-X A9064	-RRL S8324
3" hub	3½" hub	4" hub	Large closing plate	Large hub opening adapted to small hub opening

Please consult serving utility for their requirements prior to ordering or installing, as specifications and approvals vary by utility, and may require local electrical inspector approval. All installations must be installed by a licensed electrician and must comply with all national and local codes, laws and regulations. Milbank reserves the right to make changes in specifications and features shown without notice or obligation.



Connector Kits | For Use with 3/8"-16 Studs Type Units Only

Single			Twin		
Suffix	Part #	(3 per set) - 1Ø	Suffix	Part #	(3 per set) - 1Ø
K1	K1539	#6-350	K2	K1350	#6-350
K3	K1540	#4-600 or (2) #1/0-250*	K2L	K1350L	#6-350 (non-rotating)
K3L	K1540L	#4-600 or (2) #1/0-250* (non-rotating)	K4	K1541	#4-600
Suffix	Part #	(4 per set) - 3Ø	Suffix	Part #	(4 per set) - 3Ø
K5	K3082	#6-350	K6	K3442	#6-350
K7	K3441	#4-600 or (2) #1/0-250*	K8	K3083	#4-600

*For (2) 1/0-250, conductors must be of same size.

Bypass Link



K8180 (sold in pairs)

Note

Consult factory for proper connector kits for studded meter sockets.

Closing Covers

Meter Closing Plate (Ring Type/Ringless)	Metal Closing Plate (For Ringless Sockets)
6003 - Gray Plastic	CP-21
6116 - Clear Plastic	
6002 - Clear Plastic	

Disconnect Sleeve



M5-144

Do not use with lever bypass sockets

Isolated Neutral Kit



K1047

Pole Hanger Kit

850 comes with 4 pole hangers

Catalog Number	Description of pole hanger brackets
850	Two pair (4 pieces) with mounting hardware

Touch-Up Paint

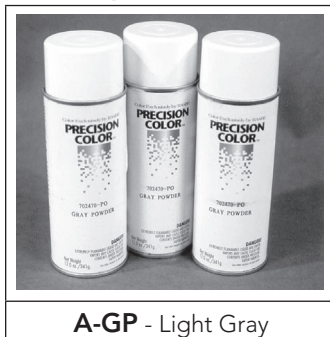



A-GP - Light Gray



Please consult serving utility for their requirements prior to ordering or installing, as specifications and approvals vary by utility, and may require local electrical inspector approval. All installations must be installed by a licensed electrician and must comply with all national and local codes, laws and regulations. Milbank reserves the right to make changes in specifications and features shown without notice or obligation.

Fifth Terminals, Tap Connectors and Block Assemblies

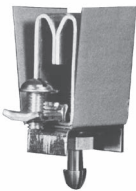
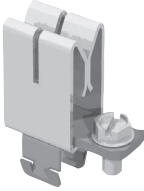
Fifth Terminals

			
5T8K2 - 100-200 Amps "Plug-In"	K5T - 200 Amps (Block with Square Hole)	K3865 - Heavy Duty Jaw Clamping (K3866 without Neutral Wire)	K3356 Fifth Terminal Kit

Tap Connectors (3 per set)

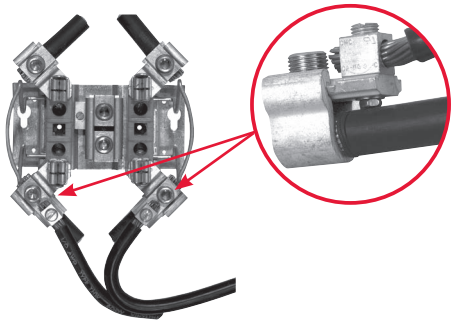
	Replaces the load or line side slide-in nut assembly on Milbank 200 Amps sockets. Allows for a 100 Amps tap location in addition to the #6-350 kcmil load-side connector. K5022 includes safety barrier extensions for applications over 300V. Three lugs per kit.
K4977-INT - Internal Hex	
K4977-EXT - External Hex	
K5022-INT - Internal Hex (set of 4 w/ barrier)	

Triplex Ground

K1190 (For factory-installed triplex ground, add suffix -TG to catalog number)

100 Amps Blocks *(single sockets only)*

BL7474 - Block Assembly
Z904486-AO - Slotted Nut Assembly
Z802965-AC - Neutral without Nut
Z901925-AC - Hex Nut Set Screw

200 Amps Blocks *(single sockets only)*

K4527 - Internal Hex Block Assembly (w/ meter support)
K4528 - External Hex Block Assembly (w/ meter support)
Z916265-AO - Internal Hex Slide Nut Assembly
Z916264-AO - External Hex Slide Nut Assembly
Z814898-AC - Neutral without Nut

Please consult serving utility for their requirements prior to ordering or installing, as specifications and approvals vary by utility, and may require local electrical inspector approval. All installations must be installed by a licensed electrician and must comply with all national and local codes, laws and regulations. Milbank reserves the right to make changes in specifications and features shown without notice or obligation.





NEMA Commercial Enclosures

Milbank's line of commercial enclosures includes the full gamut of styles and sizes: everything from junction boxes to transformer cabinets, telephone cabinets to wireways.

Type-1 Enclosures

Milbank's NEMA Type-1 enclosures are designed for indoor use to provide a degree of protection to personnel against access to hazardous parts and to provide a degree of protection of the equipment inside the enclosure against ingress of solid foreign objects, such as falling dirt.

NEMA 3R Enclosures

Milbank's NEMA 3R enclosures are designed for either indoor or outdoor use to provide a degree of protection from harmful effects on the equipment due to the ingress of water (rain, sleet, snow) or prevent damage from the external formation of ice on the enclosure.

Wireways

Milbank's wide range of wireways are available in many styles and sizes and a varied range of fittings allow smooth transitions to and from many manufacturers' products.



Please consult serving utility for their requirements prior to ordering or installing, as specifications and approvals vary by utility, and may require local electrical inspector approval. All installations must be installed by a licensed electrician and must comply with all national and local codes, laws and regulations. Milbank reserves the right to make changes in specifications and features shown without notice or obligation.

Watt-hour Meter Forms

Standard Forms | Transformer Rated or Self-Contained

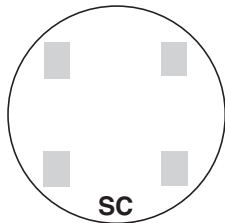

SC
2 and 3-WIRE FORMS
1S & 2S

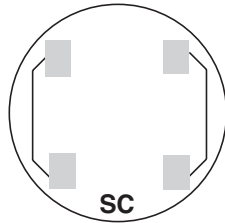

SC
2 and 3-WIRE FORMS
1S & 2S with BYPASS

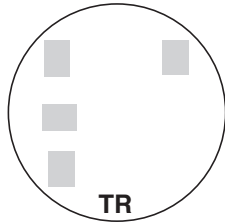

TR
2-WIRE FORM 3S
5th Term. 9 o'clock

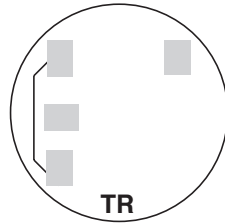

TR
2-WIRE FORM 3S
with BYPASS

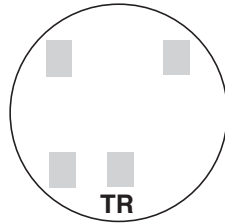

TR
2-WIRE FORM 3S
5th Term. 6 o'clock

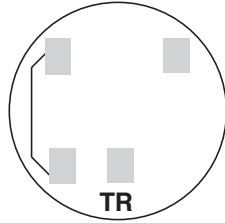

TR
2-WIRE FORM 3S
with BYPASS

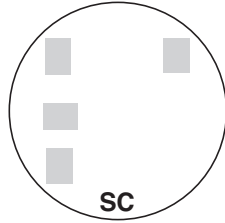

SC
2 ELEMENT
3-WIRE NETWORK
FORM 12S 5th
TERM. 9 o'clock

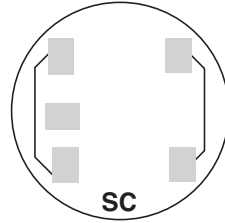

SC
2 ELEMENT 3-WIRE
NETWORK FORM 12S
with BYPASS
5th Term. 9 o'clock

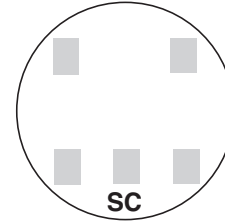

SC
2 ELEMENT
3-WIRE NETWORK
FORM 12S 5th
TERM. 6 o'clock

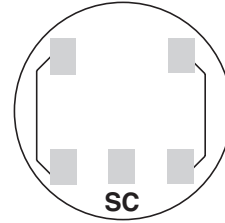

SC
2 ELEMENT 3-WIRE
NETWORK FORM 12S
with BYPASS
5th Term. 6 o'clock

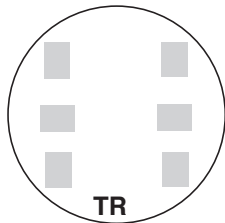

TR
3-WIRE FORM 4S

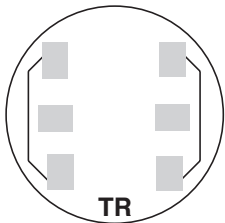

TR
3-WIRE FORM 4S
WITH BYPASS

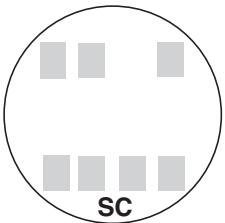

SC
2 or 3 ELEMENT
3Ø4W Y or Δ
Y FORM 14S
Δ FORM 15S

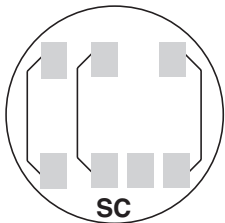

SC
2 or 3 ELEMENT
3Ø4W Y or Δ
FORMS 14S & 15S
with BYPASS

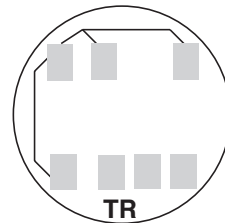

TR
2 ELEMENT
3Ø4W Y or Δ
Y FORM 7S
Δ FORM 24S
with BYPASS

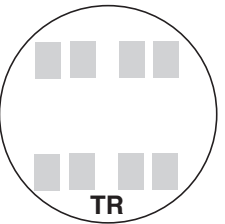

TR
2 ELEMENT
2Ø3W, 2Ø4W, 3Ø3W
FORM 5S

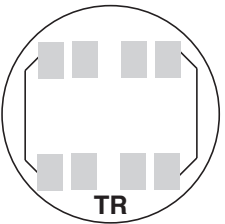

TR
2 ELEMENT 2Ø3W,
2Ø4W, 3Ø3W
FORM 5S with
BYPASS

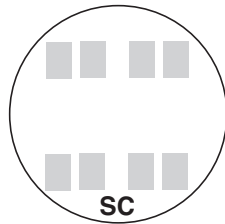

SC
2 ELEMENT
2Ø3W, 2Ø4W, 3Ø3W
FORM 13S

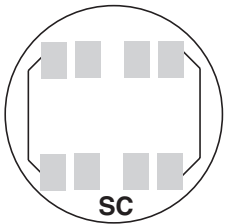

SC
2 or 3 ELEMENT
2Ø3W, 2Ø4W, 3Ø3W
FORM 13S with
BYPASS

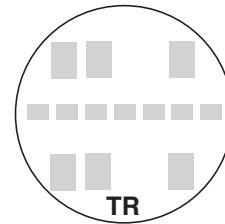

TR
2 or 3 ELEMENT
3Ø4W Y or Δ
Y FORM 9S
Δ FORM 8S

TR = TRANSFORMER RATED
SC = SELF CONTAINED

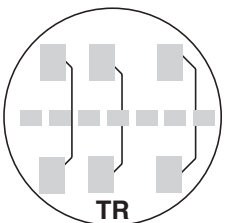

TR
2 or 3 ELEMENT

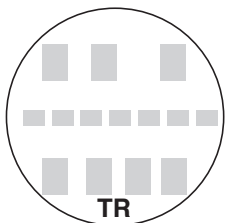

TR
2 ELEMENT

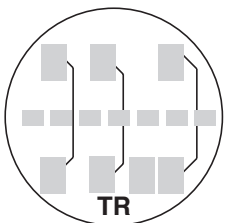

TR
2 ELEMENT

Please consult serving utility for their requirements prior to ordering or installing, as specifications and approvals vary by utility, and may require local electrical inspector approval. All installations must be installed by a licensed electrician and must comply with all national and local codes, laws and regulations. Milbank reserves the right to make changes in specifications and features shown without notice or obligation.



DIAGRAM A
 1 Δ 2W with 1 P.T. and 1 C.T.
 Single Stator Meter(2W1 Δ) - Form 35
 5T Socket, Test Switch #TS04-0101

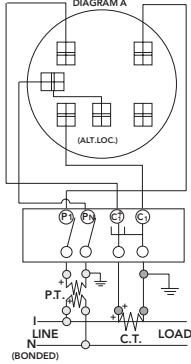

DIAGRAM B
 1 Δ 3W with 1 C.T.
 Single Stator Meter (2W1 Δ) - Form 35
 5T Socket, Test Switch #TS04-0101

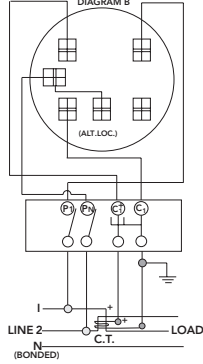

DIAGRAM C
 1 Δ 3W with 2 C.T.'s
 Single Stator Meter (3W1 Δ) - Form 45
 6T Socket, Test Switch #TS07-0105

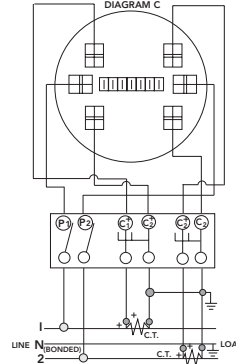

DIAGRAM D
 1 Δ 3W or 3W Network with 2 C.T.'s
 2 Stator Meter - Form 55
 8T Socket, Test Switch #TS07-0105

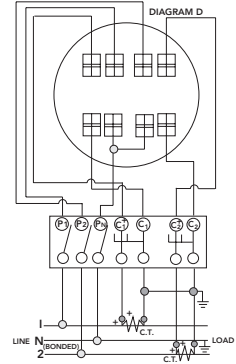

DIAGRAM E
 3 Δ 3W "A" with 2 P.T.'s and 2 C.T.'s
 2 Stator Meter - Form 55
 8T Socket, Test Switch #TS07-0105

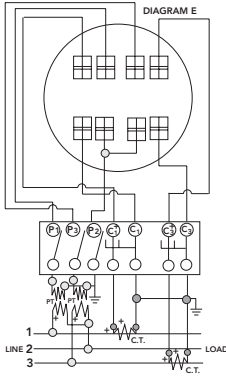

DIAGRAM F
 3 Δ 3W "A" with 2 C.T.'s
 2 Stator Meter - Form 55
 8T Socket, Test Switch #TS07-0105

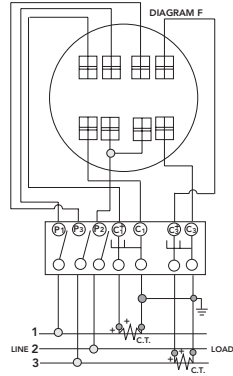

DIAGRAM G
 3 Δ 4W "Y" with 3 C.T.'s
 2 1/2 Stator Meter - Form 65
 13T Socket, Test Switch #TS10-0109

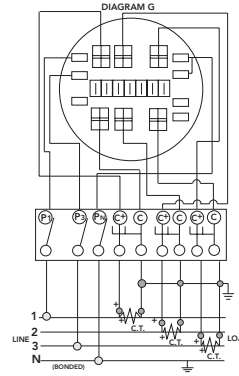

DIAGRAM H
 3 Δ 4W "Y" with 2 P.T.'s and 3 C.T.'s
 2 1/2 Stator Meter - Form 65
 13T Socket, Test Switch #TS10-0109

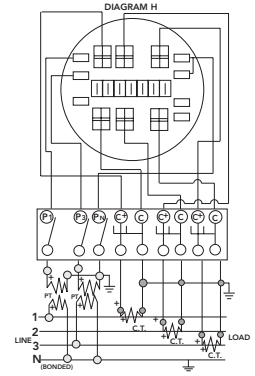

DIAGRAM I
 3 Δ 4W "Y" or "A" with 3 C.T.'s
 "Y" 3 Stator Meter - Form 95
 "A" 2 Stator Meter - Form 85
 13T Socket, Test Switch #TS10-0109

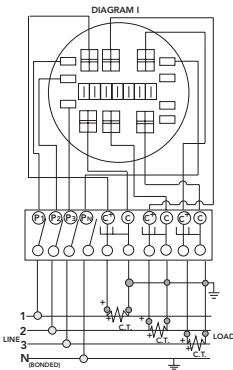
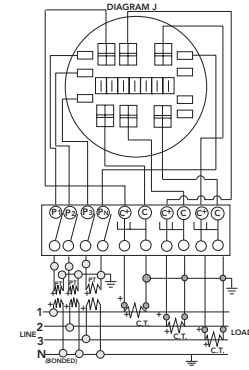

DIAGRAM J
 3 Δ 4W "Y" with 3 P.T.'s and 3 C.T.'s
 3 Stator Meter - Form 95
 13T Socket, Test Switch #TS10-0109



Prewiring: If standard factory prewiring is required, refer to wiring diagrams on this page. Determine appropriate diagram and send a copy with order. If custom factory prewiring is required, specify on order. Be sure to include meter socket catalog number, test switch make and catalog number, meter form number and provide a copy of your wiring diagram.



Please consult serving utility for their requirements prior to ordering or installing, as specifications and approvals vary by utility, and may require local electrical inspector approval. All installations must be installed by a licensed electrician and must comply with all national and local codes, laws and regulations. Milbank reserves the right to make changes in specifications and features shown without notice or obligation.

MAXIMUM NUMBER OF CONDUCTORS IN CONDUIT

Table from 2008 NEC Code Reference: Rigid Metal Conduit

Type	Conductor Size (AWG/kcmil)	Conduit Trade Sizes (Inches)									
		1/2	3/4	1	1 1/4	1 1/2	2	2 1/2	3	3 1/2	4
THHN, THWN, THWN-2	12	9	16	26	46	62	102	146	225	301	387
	10	6	10	17	29	39	64	92	142	189	244
	8	3	6	9	16	22	37	53	82	109	140
	6	2	4	4	12	16	27	38	59	79	101
	4	1	2	4	7	10	16	23	36	48	62
	3	1	1	3	6	8	14	20	31	41	53
	2	1	1	3	5	7	11	19	26	34	44
	1	1	1	1	4	5	8	12	19	25	35
	1/0	1	1	1	3	4	7	10	16	21	27
	2/0	0	1	1	2	3	6	8	13	18	23
3/0	0	1	1	1	3	5	7	11	15	19	
4/0	0	1	1	1	2	4	6	9	12	16	
XHH, XHHW, XHHW-2	4	1	2	4	7	10	16	24	37	49	63
	2	1	1	3	5	7	12	17	26	35	45
	1/0	1	1	1	3	4	7	10	16	22	28
	2/0	0	1	1	2	3	6	9	13	18	23
	4/0	0	1	1	1	2	4	6	9	12	16
	250	0	0	1	1	1	3	5	7	10	13
	350	0	0	1	1	1	2	3	6	7	10
500	0	0	0	1	1	1	2	4	5	7	
750	0	0	0	0	1	1	1	3	4	5	

This table is for concentric stranded conductors only. For cables with compact conductors refer to NEC. Refer to latest NEC Code or Local Codes for updated requirements.

SAMPLE RATING LABEL

CATALOG NUMBERS U5952 & U5953
100A MAXIMUM, 120/240 VAC SINGLE PHASE, THREE WIRE
RAINPROOF NEMA TYPE 3R

SHORT CIRCUIT CURRENT RATING IS 10,000 RMS SYMMETRICAL AMPERE AT 240 VAC MAXIMUM, BUT IS LIMITED TO THE LOWEST SHORT CIRCUIT CURRENT RATING OF ANY INSTALLED CIRCUIT BREAKER. WATTHOUR METER NOT INCLUDED IN SHORT CIRCUIT CURRENT RATING. REPLACEMENT CIRCUIT BREAKER MUST BE THE SAME TYPE AND RATING. USE SIEMENS QP, QP, CUTLER-HAMMER QP, BD, BR;
SQUARE D HOMELINE; G.E. TO, THQ, THQL

SUITABLE FOR USE AS RECREATIONAL VEHICLE SITE SUPPLY EQUIPMENT

UNDERGROUND FEED ONLY

ON TRIP OFF
TO RESET BREAKER MOVE TO "OFF" THEN TO "ON"

DANGER
HAZARD OF ELECTRICAL SHOCK OR BURN
TURN OFF POWER
SUPPLYING THIS EQUIPMENT BEFORE WORKING INSIDE

WIRE TERMINAL INFORMATION USE AL-CU CONDUCTORS		
TERMINAL	WIRE RANGE	TORQUE LB-IN
LINE AND LINE NEUTRAL	350 KCMIL - #6	250
GROUND CONNECTOR	2/0 AWG - #14 AWG	120
LOAD NEUTRAL SLOTTED HEAD (LARGE HOLE)	14 - 10 8 6 - 4 3 - 1/0	35 40 45 50
LOAD NEUTRAL SLOTTED HEAD (SMALL HOLE)	14 - 10 8 6	20 25 35

SHIPPING TENDS TO LOOSEN BOLTED CONNECTIONS. CHECK AND TIGHTEN ALL HARDWARE BEFORE ENERGIZING UNIT

SIZE OF FIELD INSTALLED CONDUCTORS SHALL BE 60° OR 75° C SIZED TO 60° C RATING FOR 110 AMPS OR LESS AND 75° C SIZED TO 75° C FOR 125 AMPS AND ABOVE

* ALLOWABLE AMPACITIES OF INSULATED COPPER and ** ALUMINUM CONDUCTORS (3W IN CONDUIT) 75° C (167° F)

A		AL or **CU-Clad AL	
A	B	A	B
18	—	—	—
16	—	—	—
14	20†	—	—
12	25†	12	20†
10	35†	10	30†
8	50	8	40
6	65	6	50
4	85	4	65
3	100	3	75
2	115	2	90
1	130	1	100
1/0	150	1/0	120
2/0	175	2/0	135
3/0	200	3/0	155
4/0	230	4/0	180
250	255	250	205
300	285	300	230
350	310	350	250
400	335	400	270
500	380	500	310
600	420	600	340
700	460	700	375
750	475	750	385

A = Size: AWG/MCM
*B = Ampere Rating for Insulation Types:
FEPW, RH, RHW, THW, THWN, XHHW, USE, 2W.
**C = Ampere Rating for Insulation Types:
RH, RHW, THW, THWN, XHHW, USE
(Per NEC table 310-16)

AMPACITY CORRECTION FACTORS

Ambient Temp. C°	Correction Factor	Ambient Temp. F°
21 - 25	1.05	70 - 77
25 - 30	1.00	78 - 86
31 - 35	.94	87 - 95
36 - 40	.88	96 - 104
41 - 45	.82	105 - 113
46 - 50	.75	114 - 122
51 - 55	.67	123 - 131
56 - 60	.58	132 - 140
61 - 65	.33	141 - 158

Overall ampere ratings of U/L listed Milbank multiple position meter sockets are based on 2008 NEC Handbook Article 220-84 and ANSI / UL-414 (except where restricted by line connector size.) These requirements provide for a diversity factor / demand factor being utilized in determining the overall (main bus / lug) rating of a gang socket. All Milbank UL-Listed gang sockets meet or exceed these diversity factor/demand and factor requirements. Standard overall ampacity ratings for UL-Listed and non-UL-Listed gang sockets are as shown in the chart below. Ampere ratings of meter sockets are based on the meter socket being wired with 75° C insulated wire conductor, sized in accordance with Table 310-16 of the National Electric Code.

GANG SOCKET OVERALL AMPACITIES

# of Meter Pos.	100A/Pos. Ampacity	125A/Pos. Ampacity	150A/Pos. Ampacity	200A/Pos. Ampacity
2	200A	200A	200A	200A #
3	200A	225A	225A	270A
4	200A	250A	270A	360A
5	225A	285A	338A	450A
6	270A	330A	396A	528A

† Unless otherwise permitted elsewhere in the Code, the overcurrent protection for conductor types marked with an obelisk (†) shall not exceed 15 Amps for 14 AWG, 20 Amps for 12 AWG, and 30 Amps for 10 AWG copper; or 15 Amps for 12 AWG and 25 Amps for 10 AWG aluminum and copper-clad aluminum after any correction factors for ambient temperature and number of conductors have been applied.
Some constructions are rated at 400 amps overall (1252). Contact your sales representative for more information. Refer to latest NEC Code or local codes for updated requirements.

Please consult serving utility for their requirements prior to ordering or installing, as specifications and approvals vary by utility, and may require local electrical inspector approval. All installations must be installed by a licensed electrician and must comply with all national and local codes, laws and regulations. Milbank reserves the right to make changes in specifications and features shown without notice or obligation.



Important Note

In addition to national and local electrical codes, many utilities have specific requirements for metering equipment. Always consult the serving utility for their specifications and requirements prior to ordering or installing Milbank meter mounting equipment.

Before Energizing

1. Give equipment a thorough visual examination to determine that:
 - A. No shipping or installation damage exists.
 - B. Proper clearances have been maintained.
 - C. All connections have been made.
 - D. Equipment is clean and dry.
2. Make a thorough examination to:
 - A. Verify tightness of all bolted connections (see table below).
 - B. Manually operate all circuit breakers, switches, relays, etc.
 - C. Check rigidity of all mountings, bus bars and components.
 - D. Use test equipment to check continuity of circuitry and integrity of insulation.
3. All switches and circuit breakers should be in the "off" position.
4. Verify that manual meter bypass (if applicable) is in non-bypass position.
5. Install cover and/or close doors.
6. If installation is not being energized at this time, follow "after energizing" steps listed below. These steps will secure the installation in case of accidental energization.

When Energizing

Use caution and follow established safety procedures:

- 1) Wear safety apparel.
- 2) Use safety equipment.
- 3) Take action to prevent injury to yourself and others in the event of failure of the installation.
- 4) Take action to prevent/decrease damage to property in the event of failure of the installation.
- 5) If you are unsure how to safely energize the installation, get someone who is knowledgeable to do it.

After Energizing

Secure the installation:

- 1) To prevent accidental contact with energized parts, cover all openings with approved filler devices.
- 2) To prevent unauthorized access, secure all covers and/or doors with approved security devices.
- 3) Attach/post information to advise others of potential hazards associated with the installation.

Recommended Torque for General Applications*

Nominal Size	Joint Description		Head Type	Torque (Inch Lbs.)
	Screw	Nut		
10	Brass	Brass Nut or Extruded Hole	All	20-25 inch lbs.
10	Steel	Copper or Aluminum Busbar ≤ 1/8"	All	25-30 inch lbs.
10	Steel	Steel Nut or Extruded Hole; CU or AL Busbar > 1/8"	All	30-35 inch lbs.
12	Steel	Aluminum Extruded Hole	All	30-35 inch lbs.
12	Steel	Steel Nut or Extruded Hole	All	40-50 inch lbs.
1/4	Steel	Aluminum Extruded Hole	All	40-50 inch lbs.
1/4	Steel	Steel Nut or Extruded Hole; CU or AL Busbar	All	50-60 inch lbs.
5/16	Steel	Aluminum Extruded Hole	Hex	60-70 inch lbs.
5/16	Steel	Steel Nut or Extruded Hole; CU or AL Busbar	Hex	100-150 inch lbs.
3/8	Steel	Steel Nut	Hex	150-200 inch lbs.
1/2	Steel	Steel Nut	Hex	200-250 inch lbs.

*Interior labels typically indicate the required torque for wire connectors and studs, and should be referenced first.
CU: Copper
AL: Aluminum



Please consult serving utility for their requirements prior to ordering or installing, as specifications and approvals vary by utility, and may require local electrical inspector approval. All installations must be installed by a licensed electrician and must comply with all national and local codes, laws and regulations. Milbank reserves the right to make changes in specifications and features shown without notice or obligation.

Materials

Steel Quality

The meter equipment listed in this catalog is made of galvanized steel (AISI* G90) to afford the best possible weather proofing.
*American Iron and Steel Institute.

Steel Sheet

16-gauge, galvanized, sheet: 1 1/4 oz./ sq.ft. class zinc-coated. (AISI G90)
14-gauge, galvanized, sheet: 1 1/4 oz./ sq.ft. class zinc-coated.

Aluminum Extrusion

Wire-Terminals: Alloy; 6061-T6, Tin-plated for CU/AL wire.
Busbar: Alloy; 6101-O and 6063-O

Aluminum Sheet

3000 series aluminum sheet, H14 or 5052 series aluminum sheet, H32. Where applicable thicknesses range from .064-.125

Copper Sheet and Bus

Electrolytic copper with tin plating in most applications.

Insulating Materials

- In most units, support bases for current-carrying components are molded from fiberglass reinforced high-strength, track resistant, thermoset polyester molding compounds.
- Clear or black safety shields and polarity barriers are molded from high-strength, track resistant, polycarbonate molding compounds.
- Various sheet insulating materials, as appropriate for the application are utilized in the fabrication of flat, formed and punched component parts and barriers.

Finish

Process

Light gray state-of-the-art electrostatically applied powder paint offers a durable, non-fading finish. For further information concerning the chemical analysis of the weather resistant finish, please contact the factory.

Metal Fasteners

Zinc-coated with a chromate dip.

Ratings and Compliance

Ratings and Compliance

All Milbank electrical enclosures in this catalog are rated "NEMA 3R Enclosure" unless specified otherwise on the product's page. All enclosures with a UL designation are constructed per the appropriate UL Standard and may be installed per the National Electric Code. UL procedure files associated with the UL Standards are listed as follows: Meter Sockets (UL 414, File E30202), Test Switches (UL 414, File E62531), Power Outlets (UL 231, File E90945), Panelboards (UL 67, File E32628) and Pullout Switches (UL 1429, File E133062). Additional standards are utilized as applicable: Meter Sockets (ANSI C12.7), Test Switches (ANSI C12.9) and Panelboards (NEMA PB-1).

Please consult serving utility for their requirements prior to ordering or installing, as specifications and approvals vary by utility, and may require local electrical inspector approval. All installations must be installed by a licensed electrician and must comply with all national and local codes, laws and regulations. Milbank reserves the right to make changes in specifications and features shown without notice or obligation.



Symbols

5T8K2..... 91
 850..... 90
 6002..... 90
 6003..... 90
 6116..... 90
 363010-CT3R*..... 41
 363016-CT3R*..... 41
 363610-CT3R*..... 41
 363612-CT3R*..... 41
 363616-CT3R*..... 41
 483616-CT3R*..... 41
 484812-CT3R*..... 41
 606013-CT3R*..... 41
 708784-MO..... 76

A

A-36P30..... 41
 A-36P30W..... 41
 A-36P36..... 41
 A-36P36W..... 41
 A-48P36..... 41
 A-48P36W..... 41
 A-48P48..... 41
 A-48P48W..... 41
 A-60P60..... 41
 A-60P60W..... 41
 A7514..... 89
 A7515..... 89
 A7516..... 89
 A7517..... 89
 A7518..... 89
 A7551..... 89
 A8110..... 89
 A8111..... 89
 A8112..... 89
 A9064..... 89
 A-GP..... 90
 ALIM-413..... 42
 ALIM-413PM..... 44
 ALIM-413UGBX..... 43
 ALIM-434..... 42
 ALIM-434PM..... 44
 ALIM-434UGBX..... 43
 ALIM-464..... 42
 ALIM-464PM..... 45
 ALIM-464UGBX..... 43
 ALIM-613..... 42
 ALIM-613PM..... 44
 ALIM-613UGBX..... 43
 ALIM-634..... 42
 ALIM-634PM..... 44

ALIM-634UGBX..... 43
 ALIM-664..... 42
 ALIM-664PM..... 45
 ALIM-664UGBX..... 43
 ALIM-813..... 42
 ALIM-813PM..... 44
 ALIM-813UGBX..... 43
 ALIM-834..... 42
 ALIM-834PM..... 44
 ALIM-834UGBX..... 43
 ALIM-864..... 42
 ALIM-864PM..... 45
 ALIM-864UGBX..... 43
 ALIM-1234..... 42
 ALIM-1234PM..... 44
 ALIM-1234UGBX..... 43
 ALIM-1264..... 42
 ALIM-1264PM..... 45
 ALIM-1264UGBX..... 43
 ALIM-1634PM..... 44
 ALIM-1664PM..... 45
 ALIM-2034PM..... 44
 ALIM-2064PM..... 45
 ALIM-2534PM..... 44
 ALIM-2564PM..... 45
 ALIM-3034PM..... 44
 ALIM-3064PM..... 45
 ALIM-CTJGL22A-413..... 49
 ALIM-CTJGL22A-434..... 49
 ALIM-CTJGL22L-413PM..... 52
 ALIM-CTJGL22L-413UGBX..... 51
 ALIM-CTJGL22L-434PM..... 52
 ALIM-CTJGL22L-434UGBX..... 51
 ALIM-CTJGL24A-464..... 49
 ALIM-CTJGL24L-464PM..... 52
 ALIM-CTJGL24L-464UGBX..... 51
 ALIM-CTJL24A-464..... 49
 ALIM-CTJL24L-464PM..... 52
 ALIM-CTJL24L-464UGBX..... 51
 ALIM-CTLGL12A-413..... 50
 ALIM-CTLGL12A-434..... 50
 ALIM-CTLGL12L-413PM..... 52
 ALIM-CTLGL12L-413UGBX..... 51
 ALIM-CTLGL12L-434PM..... 52
 ALIM-CTLGL12L-434UGBX..... 51
 ALIM-CTLGL14A-464..... 50
 ALIM-CTLGL14L-464PM..... 52
 ALIM-CTLGL14L-464UGBX..... 51
 ALIM-CTLJL14A-464..... 50
 ALIM-CTLJL14L-464PM..... 52
 ALIM-CTLJL14L-464UGBX..... 51
 ALIM-CTMGL12A-613..... 50
 ALIM-CTMGL12A-634..... 50

ALIM-CTMGL12A-813..... 50
 ALIM-CTMGL12A-834..... 50
 ALIM-CTMGL12L-613PM..... 52
 ALIM-CTMGL12L-613UGBX..... 51
 ALIM-CTMGL12L-634PM..... 52
 ALIM-CTMGL12L-634UGBX..... 51
 ALIM-CTMGL12L-813PM..... 52
 ALIM-CTMGL12L-813UGBX..... 51
 ALIM-CTMGL12L-834PM..... 52
 ALIM-CTMGL12L-834UGBX..... 51
 ALIM-CTMGL14A-664..... 50
 ALIM-CTMGL14A-864..... 50
 ALIM-CTMGL14L-664PM..... 52
 ALIM-CTMGL14L-664UGBX..... 51
 ALIM-CTMGL14L-864PM..... 52
 ALIM-CTMGL14L-864UGBX..... 51
 ALIM-CTMJL14A-664..... 50
 ALIM-CTMJL14A-864..... 50
 ALIM-CTMJL14L-664PM..... 52
 ALIM-CTMJL14L-664UGBX..... 51
 ALIM-CTMJL14L-864PM..... 52
 ALIM-CTMJL14L-864UGBX..... 51
 ALIM-CTPGL12A-1234..... 50
 ALIM-CTPGL12A-1264..... 50
 ALIM-CTPGL12L-1234PM..... 52
 ALIM-CTPGL12L-1234UGBX..... 51
 ALIM-CTPGL14L-1264PM..... 52
 ALIM-CTPGL14L-1264UGBX..... 51
 ALIM-CTPJL14A-1264..... 50
 ALIM-CTPJL14L-1264PM..... 52
 ALIM-CTPJL14L-1264UGBX..... 51
 ALIM-CTPT12A-413..... 48
 ALIM-CTPT12A-434..... 48
 ALIM-CTPT12L-413PM..... 48
 ALIM-CTPT12L-413UGBX..... 48
 ALIM-CTPT12L-434PM..... 48
 ALIM-CTPT12L-434UGBX..... 48
 ALIM-CTPT14A-464..... 48
 ALIM-CTPT14L-464PM..... 48
 ALIM-CTPT14L-464UGBX..... 48
 ALIRESM-413..... 45
 ALIRESM-434..... 45
 ALIRESM-613..... 45
 ALIRESM-634..... 45

B

BL7474..... 91

C

CCLM-22..... 53
 CCLM-36..... 53
 CCLM-48..... 53
 CCLM-60..... 53



Please consult serving utility for their requirements prior to ordering or installing, as specifications and approvals vary by utility, and may require local electrical inspector approval. All installations must be installed by a licensed electrician and must comply with all national and local codes, laws and regulations. Milbank reserves the right to make changes in specifications and features shown without notice or obligation.

CCM-36.....	53	MAEM-634.....	54	Q120.....	67,76,88	
CCM-48.....	53	MAEM-634PM.....	55	Q120H.....	88	
CCM-60.....	53	MAEM-634UGBX.....	54	Q125.....	88	
CL200D.....	68	MAEM-664.....	54	Q125H.....	88	
K						
K5T.....	91	MAEM-664PM.....	55	Q130.....	67,76,88	
K1047.....	90	MAEM-664UGBX.....	55	Q130H.....	88	
K1190.....	91	MAEM-813.....	54	Q135.....	88	
K1350.....	35,90	MAEM-813PM.....	55	Q135H.....	88	
K1350L.....	90	MAEM-813UGBX.....	54	Q140.....	88	
K1539.....	35,90	MAEM-834.....	54	Q140H.....	88	
K1540.....	35,90	MAEM-834PM.....	55	Q150.....	88	
K1540L.....	90	MAEM-834UGBX.....	54	Q150H.....	88	
K1541.....	35,90	MAEM-864.....	54	Q160.....	88	
K3082.....	90	MAEM-864PM.....	55	Q160H.....	88	
K3083.....	90	MAEM-864UGBX.....	55	Q170.....	88	
K3356.....	91	MAEM-1213.....	54	Q170H.....	88	
K3441.....	90	MAEM-1213PM.....	55	Q215.....	88	
K3442.....	90	MAEM-1213UGBX.....	54	Q215H.....	88	
K3865.....	91	MAEM-1234.....	54	Q220.....	88	
K3866.....	91	MAEM-1234PM.....	55	Q220H.....	88	
K4527.....	91	MAEM-1234UGBX.....	54	Q225.....	88	
K4528.....	91	MAEM-1264.....	54	Q225H.....	88	
K4977-EXT.....	91	MAEM-1264PM.....	55	Q230.....	88	
K4977-INT.....	91	MAEM-1264UGBX.....	55	Q230H.....	88	
K5022-INT.....	91	MAEM-1634.....	54	Q235.....	88	
K5415.....	68	MAEM-1634PM.....	55	Q235H.....	88	
K5421.....	68	MAEM-1634UGBX.....	54	Q240.....	88	
K5920-10GR.....	71	MAEM-1664.....	54	Q240H.....	88	
K5920-11GR.....	71	MAEM-1664PM.....	55	Q250.....	67,76,88	
K5920-38.....	71	MAEM-1664UGBX.....	55	Q250H.....	88	
K5920-41.....	71	MAEM-2034.....	54	Q260.....	88	
K5920-54.....	71	MAEM-2034PM.....	55	Q260H.....	88	
K5920-58.....	71	MAEM-2034UGBX.....	54	Q270.....	88	
K5920-75.....	71	MAEM-2064.....	54	Q270H.....	88	
K5920-111GR.....	71	MAEM-2064PM.....	55	Q280.....	88	
K5920-522.....	71	MAEM-2064UGBX.....	55	Q280H.....	88	
K5920-BLANK.....	71	MAEM-2534.....	54	Q290.....	88	
K5960.....	68	MAEM-2534PM.....	55	Q290H.....	88	
L						
L572-XL-KK-CECHA.....	25	MAEM-2534UGBX.....	54	Q2100.....	88	
L573-XL-KK-CECHA.....	25	MAEM-2564.....	54	Q2100H.....	88	
L574-XL-KK-CECHA.....	25	MAEM-2564PM.....	55	Q2125.....	88	
L575-XL-KK-CECHA.....	25	MAEM-2564UGBX.....	55	Q2125H.....	88	
L576-XL-KK-CECHA.....	25	MAEM-3034.....	54	QN2150.....	88	
M						
M5-144.....	90	MAEM-3034PM.....	55	QN2150H.....	88	
MAEM-613.....	54	MAEM-3034UGBX.....	54	QN2150R.....	88	
MAEM-613PM.....	55	MAEM-3064.....	54	QN2150RH.....	88	
MAEM-613UGBX.....	54	MAEM-3064PM.....	55	QN2200.....	88	
Q						
Q115.....	88	MAEM-3064UGBX.....	55	QN2200H.....	88	
Q115H.....	88	MR-2.....	67,76	QN2200R.....	88	
S						
					S8324.....	89

Please consult serving utility for their requirements prior to ordering or installing, as specifications and approvals vary by utility, and may require local electrical inspector approval. All installations must be installed by a licensed electrician and must comply with all national and local codes, laws and regulations. Milbank reserves the right to make changes in specifications and features shown without notice or obligation.



S9690-O	41	U1253-RRL-KK-K1	28	U3822-20GWR	7
S9691-O*	41	U1253-X-KK-K1	27,28	U3832	6
S9692-O*	41	U1254-RRL-KK-K1	28	U3850-O-TG-KK-5T	10
SC6128-XL-TS100109**	38	U1254-X-KK-K1	27,28	U3850-O-TG-KK-ALT	10
T					
TBALIM-413-1	46	U1255-RRL-KK-K1	28	U3862	6
TBALIM-434-1	46	U1255-X-KK-K1	27,28	U4322-O-100MB	61
TBALIM-613-2	46	U1256-RRL-KK-K1	28	U4322-O-200MB	61
TBALIM-634-2	46	U1256-X-KK-K1	27,28	U4323-O-100MB	61
TBALIM-813-3	46	U1493-X-ALT	13	U4323-O-200MB	61
TBALIM-834-3	46	U1748-O*	63	U4540-XL	77
TBALIM-1234-5	46	U1748-O-5T9-WI*	63	U4542-XL	77
TBBXALIM-413-1	46	U1748-O-WI*	63	U4544-XL	77
TBBXALIM-434-1	46	U1773-XL-TG-KK	9	U4546-XL	77
TBBXALIM-613-2	46	U1773-XL-TG-KK-5T	9	U4548-RXL	77
TBBXALIM-634-2	46	U1779-RRL-K3-K2	14	U4549-RXL	77
TBBXALIM-813-3	46	U1779-RRL-K3-K2-ALT	14	U4721-O-BL-ALT	11,12
TBBXALIM-834-3	46	U1783-O-KK	56	U4724-O	57
TBBXALIM-1234-5	46	U1783-O-KK-5T	56	U4801-XL	12
TBPMALIM-413-1	47	U1797-O-K3L-K2L	14	U4801-XL-5T9	11
TBPMALIM-434-1	47	U2120-X-K7	15	U4801-XL-ALT	11
TBPMALIM-613-2	47	U2124-X-5T9	14	U4833-O-5T9	57
TBPMALIM-634-2	47	U2448-X	14	U4908-O-100MB-KK-11GR	64
TBPMALIM-813-3	47	U2448-X-5T9	14	U4908-O-100MB-KK-76GBGR	64
TBPMALIM-834-3	47	U2594-X-K7	15	U4910-O-BL-ALT	13
TBPMALIM-1234-5	47	U2594-X-K7-ALT	15	U5000-XL	69
TBPMALIM-1634-4	47	U2732-XT	31	U5000-XL-41	69
TBPMALIM-2034-5	47	U2732-XT-K7	31	U5000-XL-55	69
TBPMALIM-2534-7	47	U2733-XT	31	U5000-XL-75	69
TBPMALIM-3034-8	47	U2733-XT-K7	31	U5100-XL	69
TS04-0101	39	U2734-XT	31	U5100-XL-41	69
TS04-0102	39	U2734-XT-K7	31	U5100-XL-55	69
TS04-0103	39	U2735-XT	31	U5100-XL-75	69
TS04-0104	39	U2735-XT-K7	31	U5101-100MB-KK-11GR	64
TS07-0018	39	U2736-XT	31	U5101-100MB-KK-76GBGR	64
TS07-0022	39	U2736-XT-K7	31	U5101-XL-11GR	64
TS07-0049	39	U2872-XT-5T9	30	U5136-O-100S	60
TS07-0059	39	U2872-XT-5T9-K3	29	U5136-O-100S-ALT	60
TS07-0105	39	U2873-XT-5T9	30	U5136-O-150S	60
TS07-0106	39	U2874-XT-5T9	30	U5136-O-200S	60
TS07-0107	39	U2875-XT-5T9	30	U5136-O-200S-ALT	60
TS07-0108	39	U2876-XT-5T9	30	U5137-O-100S	60
TS10-0109	39	U3000-O-K3L-K2L-ALT	14	U5137-O-100S-ALT	60
TS10-0110	39	U3358-O-KK	56	U5137-O-150S	60
TS10-0111	39	U3358-O-KK-5T	56	U5137-O-200S	60
TS10-0112	39	U3358-O-KK-ALT	56	U5137-O-200S-ALT	60
U					
U1252-RRL-KK-K1	28	U3491-XL-150-KK	16	U5168-XTL-100-KK	18
U1252-X-KK-5T-K1	27	U3491-XL-200-KK	16	U5168-XTL-100-KK-ALT	18
U1252-X-KK-K1	28	U3499-XL-100-KK	16	U5168-XTL-150-KK	18
U1252-X-KK-K1-ALT	27	U3741-XL-100-BL	16	U5168-XTL-150-KK-ALT	18
		U3771-XL-100	16	U5168-XTL-200-KK	18
		U3791N-RXL-200-BL	16	U5168-XTL-200-KK-5T	18
		U3802	6	U5168-XTL-200-KK-ALT	18
		U3812	6	U5200-XL	70



Please consult serving utility for their requirements prior to ordering or installing, as specifications and approvals vary by utility, and may require local electrical inspector approval. All installations must be installed by a licensed electrician and must comply with all national and local codes, laws and regulations. Milbank reserves the right to make changes in specifications and features shown without notice or obligation.

U5200-XL-41	70	U5925-O-100-KK-ALT	59	U7366-RL-KK.....	23
U5200-XL-55	70	U5925-O-150-KK	59	U7375-RL-100-TG-KK	18
U5200-XL-75.....	70	U5925-O-150-KK-ALT	59	U7487-O-TG-KK.....	8
U5220-XL.....	70	U5925-O-200-KK.....	59	U7487-RL-TG-KK.....	8
U5220-XL-41.....	70	U5925-O-200-KK-ALT.....	59	U7487-RL-TG-KK-5T	8
U5220-XL-55	70	U5950-O-41	65	U7487-RL-TG-KK-ALT	8
U5220-XL-75.....	70	U5950-O-55	65	U7487-XL-TG-KK	8
U5268-XTL-150-KK	18	U5950-O-75.....	65	U8032-RL-KK.....	26
U5268-XTL-200-KK.....	18	U5951-O-41	65	U8032-XL-KK.....	26
U5300-O.....	70	U5951-O-55.....	65	U8032-XL-KK-5T9	26
U5300-O-41	70	U5951-O-75.....	65	U8033-RL-KK.....	26
U5300-O-55.....	70	U5952-XL-41	66	U8033-XL-KK.....	26
U5300-O-75	70	U5952-XL-55.....	66	U8034-RL-KK.....	26
U5320-O.....	70	U5952-XL-75.....	66	U8034-XL-KK.....	26
U5320-O-41	70	U5953-O-41	66	U8035-RL-KK.....	26
U5320-O-55	70	U5953-O-55	66	U8035-XL-KK.....	26
U5320-O-75.....	70	U5953-O-75.....	66	U8036-RL-KK.....	26
U5701-O-100S.....	62	U5972-XT-5T9	35	U8036-XL-KK.....	26
U5701-O-200S	62	U5973-XT-5T9	35	U8212-RL-KK	24
U5702-O-100S.....	62	U5974-XT-5T9	35	U8212-XL-KK	24
U5702-O-200S	62	U5975-XT-5T9	35	U8213-RL-KK	24
U5750-RXL-200-BL	17	U5976-XT-5T9	35	U8213-XL-KK	24
U5764-X-200-5T-CB	22	U6012-XL-100-K1-ALT.....	18	U8214-RL-KK	24
U5764-X-200-CB.....	22	U6012-XL-200	19	U8214-XL-KK	24
U5767-X-200-CB	22	U6012-XL-200-K1-5T9	19	U8215-RL-KK	24
U5784-O-200-CB	22	U6012-XL-200-K1-ALT	19	U8215-XL-KK	24
U5794-X-400-5T-CB.....	22	U6221-O-100-10GR†	62	U8216-RL-KK.....	24
U5794-X-400-CB	22	U6221-O-200-10GR†.....	62	U8216-XL-KK.....	24
U5796-X-400-CB	22	U6318-O-2/150-K3L	63	U8436-O-CECHA.....	56
U5797-O-400-CB.....	22	U6318-O-2/200-K3L.....	63	U9107-O-WI	58
U5871-XL-100	18,19	U6318-O-2/200-K3L†	63	U9550-RRL.....	12
U5871-XL-200.....	19	U6318-O-100-200-K3L.....	63	U9551-RXL.....	12
U5882-X-KK-K1	33	U6513-XL-BL-ALT	11,12	U9700-RRL	13
U5882-X-KK-K1-ALT	32	U6585-X-2-150-K3L-ALT.....	20	U9701-RXL	13
U5883-X-KK-K1	33	U6585-X-2/200-K3L-ALT*	20	U9701-RXL-ALT	13
U5883-X-KK-K1-ALT	32	U6585-X-200-100-K3L-ALT	20	U9800-RRL	12
U5884-X-KK-K1	33	U6602-X-2/200-MLK-BL.....	21	U9800-RRL-5T9.....	12
U5884-X-KK-K1-ALT	32	U6605-2/200-MLK.....	21	U9801-RRL.....	12
U5885-X-KK-K1	33	U6605-X-2/200	21	U9801-RXL.....	12
U5885-X-KK-K2-ALT	32	U7021-RL-TG-KK.....	9	U9865-RRL	12
U5886-X-KK-K1	33	U7040-O-TG-KK.....	9	U9865-RRL-5T9.....	12
U5886-X-KK-K2-ALT.....	32	U7040-RL-TG-KK	9	U9865-RRL-K1	12
U5902-X-KK.....	33	U7040-XL-TG-KK	9	U9865-RXL-2/K1-ALT	12
U5902-X-KK-K1	32	U7040-XL-TG-KK-5T.....	9	UC7442-O.....	36
U5903-X-KK.....	33	U7040-XL-TG-KK-ALT	9	UC7442-RL	36
U5903-X-KK-K1	32	U7043-XL-TG-KK.....	9	UC7444-RL	37
U5904-X-KK.....	33	U7043-XL-TG-KK-ALT.....	9	UC7444-XL	37
U5904-X-KK-K1	32	U7262-RL-TG-KK.....	8	UC7445-O	38
U5905-X-KK.....	33	U7362-RL-KK	23	UC7445-RL	38
U5905-X-KK-K1	32	U7362-RL-KK-5T9	23	UC7445-XL	38
U5906-X-KK.....	33	U7363-RL-KK.....	23	UC7445-XL-TS100109*	38
U5906-X-KK-K1	32	U7364-RL-KK.....	23	UC7446-XL-121-ALT	36
U5925-O-100-KK	59	U7365-RL-KK.....	23	UC7448-RL-351†	37

Please consult serving utility for their requirements prior to ordering or installing, as specifications and approvals vary by utility, and may require local electrical inspector approval. All installations must be installed by a licensed electrician and must comply with all national and local codes, laws and regulations. Milbank reserves the right to make changes in specifications and features shown without notice or obligation.



UC7448-XL-341†	37	Z708080-MO	67,76
UC7449-XL-871-ALT	38	Z708767-MO	67,76
UC7478-O	36	Z802965-AC	91
UC7478-RL	36	Z814898-AC	91
UC7478-XL	36	Z818052-SC	76
UC7532-XL-401-ALT	36	Z901925-AC	91
UQFB-100	87	Z904486-AO	91
UQFB-100-X1	87	Z915141-AC	67,76
UQFB-125	87	Z916264-AO	91
UQFB-125-X1	87	Z916265-AO	91
UQFB-150	87	Z917602-AC	76
UQFB-150-X1	87	Z918449-AC	76
UQFB-175	87	Z918466-AC	76
UQFB-175-X1	87	Z1002682	68
UQFB-200	87	Z1002769	68
UQFB-200-X1	87	Z1050761	67
UQFBH-100	87	Z1144586	67
UQFBH-125	87	Z1144587	67
UQFBH-150	87	Z1144588	68
UQFBH-175	87	Z1144618	67
UQFBH-200	87	Z1144921	67
UQFBH-M-100	87	Z1144946	67
UQFBH-M-125	87	Z1147928	67
UQFBH-M-150	87		
UQFBH-M-175	87		
UQFBH-M-200	87		
UQFP-100	87		
UQFP-125	87		
UQFP-150	87		
UQFP-175	87		
UQFP-200	87		
UQFPH-100	87		
UQFPH-125	87		
UQFPH-150	87		
UQFPH-175	87		
UQFPH-200	87		
UQFPH-M-100	87		
UQFPH-M-125	87		
UQFPH-M-150	87		
UQFPH-M-175	87		
UQFPH-M-200	87		
UQFP-M-100	87		
UQFP-M-125	87		
UQFP-M-150	87		
UQFP-M-175	87		
UQFP-M-200	87		

W

WBJ2150	88
WBJ2200	88

Z

Z701776-MO	67,76
------------	-------



Please consult serving utility for their requirements prior to ordering or installing, as specifications and approvals vary by utility, and may require local electrical inspector approval. All installations must be installed by a licensed electrician and must comply with all national and local codes, laws and regulations. Milbank reserves the right to make changes in specifications and features shown without notice or obligation.



MILBANK[®]
ENERGY AT WORK

Milbank Manufacturing | 4801 Deramus Ave., Kansas City, MO 64120 | 877.483.5314
milbankworks.com | @milbankworks