



MILBANK[®]
ENERGY AT WORK



MEG Approval

Meter Equipment Group



Milbank designs and manufactures electrical solutions that move and manage power for the residential, commercial, industrial, utility and transportation sectors. With more than 90 years of expertise in electrical engineering design and manufacturing, Milbank's portfolio includes metering equipment, enclosures and enclosed controls. Founded in 1927, Milbank is a family-owned, American manufacturer headquartered in Kansas City, Mo. For more information, please visit milbankworks.com.

METERING



As a market leader in electrical metering equipment, Milbank has set the standard for quality since 1927. Hundreds of configurations are available, including many sizes, knockout configurations, terminal configurations, bypass options, hubs, locks and connectors. Milbank has the socket you need with thousands of active products to meet your utility's requirements.

ENCLOSURES



Milbank's line of enclosures include commercial junction boxes, panel mount enclosures, transformer cabinets, wireway, and troughs. Built with high-quality craftsmanship and materials which meet or exceed industry standards, Milbank enclosures are made to protect controls and equipment from dust, dirt and other harmful elements found in a wide variety of environments based on various NEMA rating Milbank offers.

ENCLOSED CONTROLS



Milbank doesn't just build empty enclosures. We can deliver the entire package, complete with custom control equipment built to your exact specifications by our engineers. Milbank commercial pedestals are an attractive, secure, easy to install and cost-effective solution when underground remote site power distribution and control equipment is required, replacing unsightly and inefficient strut and backboard structures.



Please consult serving utility for their requirements prior to ordering or installing, as specifications and approvals vary by utility, and may require local electrical inspector approval. All installations must be installed by a licensed electrician and must comply with all national and local codes, laws and regulations. Milbank reserves the right to make changes in specifications and features shown without notice or obligation.

Table of Contents

Air Conditioner Disconnects

30-60 Amps AC disconnects	5
60 Amps AC disconnect with 20 Amps GFCI receptacle.....	6
Hot tub disconnects.....	7

Single Position Sockets

125 Amps, 4 & 5 terminal, ringless	8
200 Amps, 4 & 5 terminal, ringless.....	9
125 Amps, 5 & 7 terminal, lever bypass, ringless	10
200 Amps, 4 & 5 terminal, lever bypass, ringless	11
200 Amps, 7 terminal, lever bypass, ringless.....	12
320 Amps, 4 terminal, lever bypass, ringless.....	13
320 Amps, 5 terminal, lever bypass, ringless.....	14
320 Amps, 7 terminal, lever bypass, ringless.....	15
600 Amps (480A continuous), 4 & 7 terminal, bolt-in bypass, ringless	16

Meter Mains

100-200 Amps, 4 terminal, ringless	18
100-200 Amps, 4 terminal, with load center, ringless.....	19
320 Amps, 4 terminal, with and without load center, ringless.....	20

Multi-Position

100 Amps, 4 terminal, ringless	21
150 Amps, 4 terminal, ringless	22
200 Amps, 4 terminal, ringless	23
200 Amps, 5 terminal, ringless, Heavy Duty Lever Bypass.....	24
200 Amps, 7 terminal, ringless, Heavy Duty Lever Bypass.....	25

Multi-Position Meter Mains

100 & 200 Amps, 4 terminal, ringless.....	26
---	----

Temporary Power

100 & 200 Amps, 4 terminal, ringless.....	27
---	----

Pedestals

100-200 Amps, 4 terminal, meter main with load center pedestal	28-30
--	-------

Miscellaneous

Replacement parts & Accessories	31-33
Enclosed Controls	34-46
Reference information	47-50
Index.....	51

Please consult serving utility for their requirements prior to ordering or installing, as specifications and approvals vary by utility, and may require local electrical inspector approval. All installations must be installed by a licensed electrician and must comply with all national and local codes, laws and regulations. Milbank reserves the right to make changes in specifications and features shown without notice or obligation.



Catalog Number Logic

How our product catalog numbers are derived

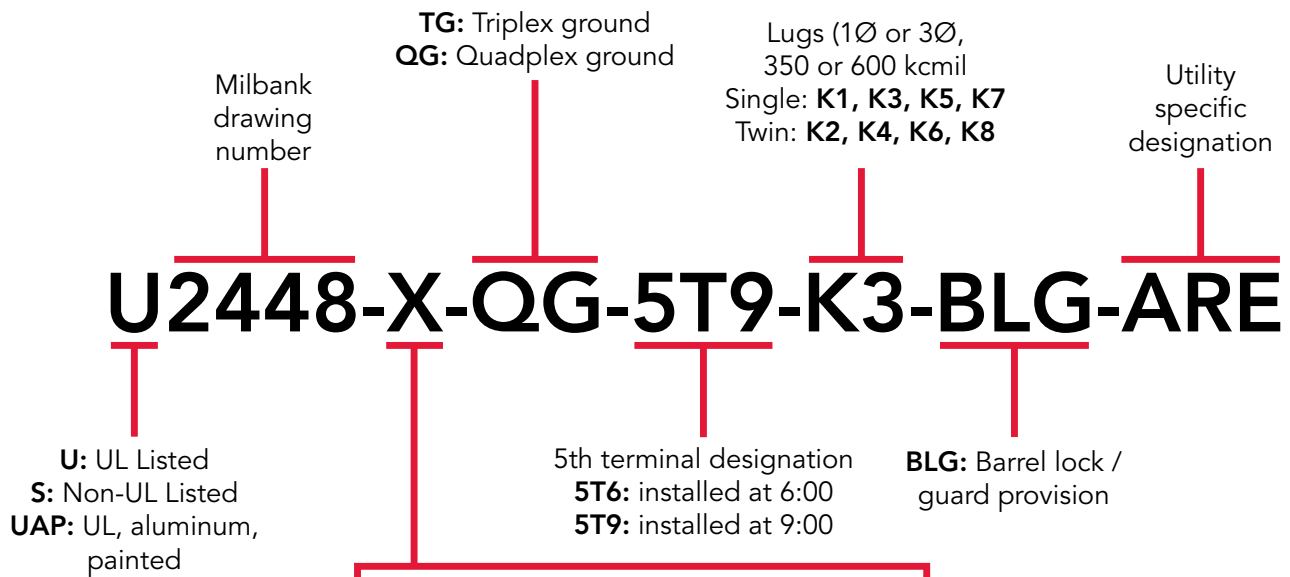

Hub Openings & Closing Plates

-O	Blank top	-WL	1" hub
-RL	Small hub opening	-YL	1¼" hub
-R	Large hub opening	-ZL	1½" hub
-XL	Small closing plate	-DL	2" hub
-X	Large closing plate	-EL	2½" hub
-RXL	Large hub opening adapted to small closing plate	-F	3" hub
-RRL	Large hub opening adapted to small hub opening	-G	3½" hub
-PXL	Closing plate packed inside	-H	4" hub

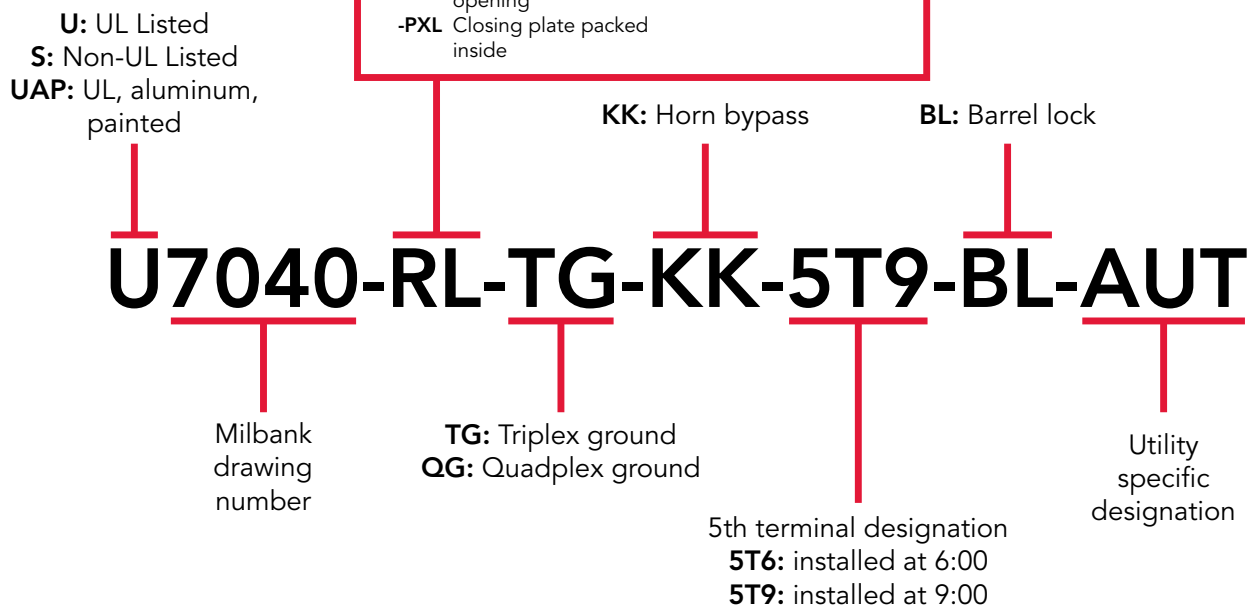

Please consult serving utility for their requirements prior to ordering or installing, as specifications and approvals vary by utility, and may require local electrical inspector approval. All installations must be installed by a licensed electrician and must comply with all national and local codes, laws and regulations. Milbank reserves the right to make changes in specifications and features shown without notice or obligation.

Air Conditioner Disconnects

30-60 Amps | Fusible & Non-Fusible



U3802



U3812



U3832

Milbank's air conditioner disconnect has a removable hinged cover which makes wiring a breeze. Our compact design meets all wire bending space requirements in the NEC and, also, complies with Article 440-14 in the NEC. To ensure the safest conditions, we designed our disconnect pullouts to be removable so they may be reinstalled in the off position. Another safety feature is the padlock provision on the front cover. As with all Milbank products, our enclosure is constructed of G90U galvanized steel and finished with an attractive, light gray, baked powder coating. Our state of the art finish combines epoxy and polyester hybrid resins into a hybrid powder coating which is then electrostatically applied. This offers a durable, nonfading finish.

30-60 Amps | 1Ø 240 VAC | Air Conditioner Disconnects

Catalog Number	Amps	Type	Max H.P.	Weight (lbs.)	Line/Load Wire Range		Ground Wire Range CU/AL	Dimensions			Wire Rating	
					CU	AL		D"	W"	H"	CU °C	AL °C
U3802	60	Non-Fusible	10	3.25	#14-#2	#12-#2	#14-4	2½	5	7½	60°/75°	60°/75°
U3812	60	Non-Auto	10	3.25	#14-#2	#12-#2	#14-4	2½	5	7½	60°/75°	60°/75°
U3832	30	Fusible	3	2.5	#14-#3	#14-#3	#14-3	2½	5	7	60°/75°	60°/75°
U3862	60	Fusible	10	3.3	#14-#3	#14-#3	#14-3	2½	5	9	60°/75°	60°/75°

Notes

- UL listed as Enclosed Pullout Switch
- Type 3R weather resistant
- One-inch concentric knockouts

Please consult serving utility for their requirements prior to ordering or installing, as specifications and approvals vary by utility, and may require local electrical inspector approval. All installations must be installed by a licensed electrician and must comply with all national and local codes, laws and regulations. Milbank reserves the right to make changes in specifications and features shown without notice or obligation.



Air Conditioner Disconnects

60 Amps | With 20 Amps GFCI Receptacle



U3822-20GWR

Specifications

- Meets NEC #210.63 requirements
- UL listed as Power Outlet
- Type 3R weather resistant
- In-use cover*
- Duplex ground connector
- One-inch concentric knockouts
- 1Ø, 240 volt
- 60 Amps, non-fused
- 20 Amps GFCI receptacle
- Reset/test button
- Meets NEC #406.8 requirements

60 Amps | 1Ø, 240 VAC | Air Conditioner Disconnect with GFCI Receptacle

Catalog Number	Type	Max H.P.	Weight (lbs.)	Line/Load Wire Range		Ground Wire Range CU/AL	Dimensions			Wire Rating	
				CU	AL		D"	W"	H"	CU °C	AL °C
U3822-20GWR	Non-Fusible	10	6	#14-#2	#12-#2	#14-4	4½"	5¼"	7½"	60°/75°	60°/75°

Notes

- **Disconnect Pullouts:** To ensure the safest conditions, Milbank disconnect pullouts are reversible so they may be reinstalled in the OFF position.
- **Padlock Provision:** All units are designed with a padlock provision on the cover for security.
- ***In-Use Cover:** Cover is rated as an in-use cover (cover may be closed with cords plugged into receptacle).



Please consult serving utility for their requirements prior to ordering or installing, as specifications and approvals vary by utility, and may require local electrical inspector approval. All installations must be installed by a licensed electrician and must comply with all national and local codes, laws and regulations. Milbank reserves the right to make changes in specifications and features shown without notice or obligation.

Hot Tub Disconnects

Type 3R Enclosures



U4881-O-50GB



U4881-O-60GB

Specifications

- 240 volt ground fault protection
- UL listed
- Type 3R weather resistant
- 2-pole, 50 or 60 Amps GFCI breaker protection
- Compact size
- Three or four wire installation
- 1Ø, 120/240 VAC
- Standard package of 12
- Two extra one-pole breaker spaces
- 100 Amps overall rating
- Easy to install

100 Amps | Hot Tub Disconnect or Sub Panel Breaker Enclosure | Type 3R

Catalog Number	Breaker Amps	Type	Weight (lbs.)	Line/Load Wire Range		Ground Wire Range CU/AL	Dimensions		
				CU	AL		D"	W"	H"
U4881-O	—	Breaker Provision	7	#14-1/0	#14-1/0	#14-1/0	3¾	7½	8½
U4881-O-50GB	50	Breaker	8	#14-1/0	#14-1/0	#14-1/0	3¾	7½	8½
U4881-O-60GB	60	Breaker	8	#14-1/0	#14-1/0	#14-1/0	3¾	7½	8½

Please consult serving utility for their requirements prior to ordering or installing, as specifications and approvals vary by utility, and may require local electrical inspector approval. All installations must be installed by a licensed electrician and must comply with all national and local codes, laws and regulations. Milbank reserves the right to make changes in specifications and features shown without notice or obligation.



Single Position Sockets

125 Amps | 4 & 5 Terminal | Ringless | 600 VAC



U8435-XL-TG-HSP

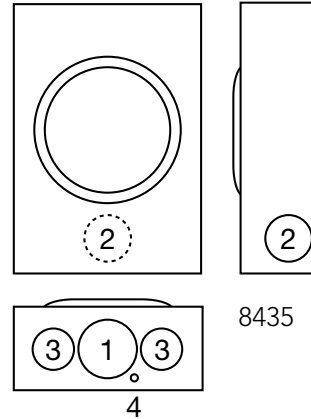

125 Amps | 4 Terminal | Ringless | Single Position | 1Ø3W

Catalog Number	Material	Service	Hub	Connectors CU/AL		Bypass	Dimensions			Knockouts			
				Line	Load		D"	W"	H"	1	2	3	4
U8435-XL-TG-HSP	Steel	OH	C.P.	#6-2/0	#6-2/0	None	3 ⁵ / ₁₆	8	11 ¹ / ₂	2	1 ¹ / ₂	1 ¹ / ₄	1 ¹ / ₄
UAP8435-XL-TG-HSP	Aluminum	OH	C.P.	#6-2/0	#6-2/0	None	3 ⁵ / ₁₆	8	11 ¹ / ₂	2	1 ¹ / ₂	1 ¹ / ₄	1 ¹ / ₄

125 Amps | 5 Terminal | Ringless | Single Position | 1Ø3W

Catalog Number	Material	Service	Hub	Connectors CU/AL		Bypass	Dimensions			Knockouts			
				Line	Load		D"	W"	H"	1	2	3	4
U8435-XL-TG-5T-HSP	Steel	OH	C.P.	#6-2/0	#6-2/0	None	3 ⁵ / ₁₆	8	11 ¹ / ₂	2	1 ¹ / ₂	1 ¹ / ₄	1 ¹ / ₄
UAP8435-XL-TG-5T-HSP	Aluminum	OH	C.P.	#6-2/0	#6-2/0	None	3 ⁵ / ₁₆	8	11 ¹ / ₂	2	1 ¹ / ₂	1 ¹ / ₄	1 ¹ / ₄

Notes

- **Fifth Terminal:** For field-installed fifth terminal, order catalog number **5T8K2**.
- **Connectors:** Extruded aluminum connectors are tin plated. Units are supplied with a triplex ground.
- **Hubs:** For proper hub selection, see hub suffix chart on accessories page.



Please consult serving utility for their requirements prior to ordering or installing, as specifications and approvals vary by utility, and may require local electrical inspector approval. All installations must be installed by a licensed electrician and must comply with all national and local codes, laws and regulations. Milbank reserves the right to make changes in specifications and features shown without notice or obligation.

Single Position Sockets

200 Amps | 4 & 5 Terminal | Ringless | 600 VAC

9
200 AMPS
SINGLE POSITION
SOCKETS



U7021-RL-TG-HSP

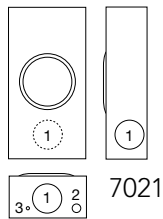

U3850-XL-TG-HSP-PL

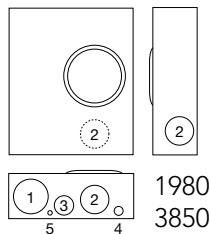

U1980-O-HSP



U7040-O-TG-HSP

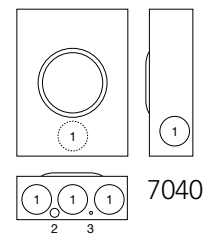

200 Amps | 4 Terminal | Ringless | Single Position | 1Ø3W

Catalog Number	Material	Service	Hub	Connectors CU/AL		Bypass	Dimensions			Knockouts				
				Line	Load		D"	W"	H"	1	2	3	4	5
U7021-RL-TG-HSP	Steel	OH	H.O.	#6-350	#6-350	None	4½	8	15½	2½	¼, ½	¼	—	—
UAP7021-RL-TG-HSP	Aluminum	OH	H.O.	#6-350	#6-350	None	4½	8	15½	2½	¼, ½	¼	—	—
U3850-XL-TG-HSP-PL	Steel	OH/UG	C.P.	#6-350	#6-350	None	4½	13	15¼	3	2½	1½	¼, ½	¼
U7040-XL-TG-HSP	Steel	OH/UG	C.P.	#6-350	#6-350	None	4½	11	14¾	2½	¼, ½	¼	—	—
UAP7040-XL-TG-HSP	Aluminum	OH/UG	C.P.	#6-350	#6-350	None	4½	11	15½	2½	¼, ½	¼	—	—
U7040-O-TG-HSP	Steel	UG	Blank	#6-350	#6-350	None	4½	11	14¾	2½	¼, ½	¼	—	—
UAP7040-O-TG-HSP	Aluminum	UG	Blank	#6-350	#6-350	None	4½	11	15½	2½	¼, ½	¼	—	—
U1980-O-HSP	Steel	UG	Blank	#6-350	#6-350	None	4½	13	15¼	3	2½	1½	¼, ½	¼

200 Amps | 5 Terminal | Ringless | Single Position | 1Ø3W

Catalog Number	Material	Service	Hub	Connectors CU/AL		Bypass	Dimensions			Knockouts				
				Line	Load		D"	W"	H"	1	2	3	4	5
U7040-XL-TG-5T-HSP	Steel	OH/UG	C.P.	#6-350	#6-350	None	4½	11	14¾	2½	¼, ½	¼	—	—
UAP7040-XL-TG-5T-HSP	Aluminum	OH/UG	C.P.	#6-350	#6-350	None	4½	11	15½	2½	¼, ½	¼	—	—
U1980-O-5T-HSP	Aluminum	UG	Blank	#6-350	#6-350	None	4½	13	15¼	3	2½	1½	¼, ½	¼

Notes

- **Hubs:** For proper hub selection, see the hub suffix chart on the accessories page.
- **Fifth Terminal:** For field-installed fifth terminal, order catalog number **K5T**.
- **Connectors:** Extruded aluminum connectors are tin plated. Units are supplied with a triplex ground.

Please consult serving utility for their requirements prior to ordering or installing, as specifications and approvals vary by utility, and may require local electrical inspector approval. All installations must be installed by a licensed electrician and must comply with all national and local codes, laws and regulations. Milbank reserves the right to make changes in specifications and features shown without notice or obligation.



Single Position Lever Bypass

125 Amps | 5 & 7 Terminal | Ringless | 600 VAC



U3505-XL-TG-HSP

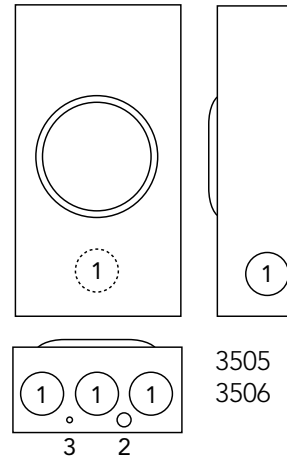

125 Amps | Ringless | Lever Bypass | Single Position | 1Ø3W

Catalog Number	Material	Terminal	Service	Hub	Connectors CU/AL		Bypass	Dimensions			Knockouts		
					Line	Load		D"	W"	H"	1	2	3
U3505-XL-TG-HSP	Steel	5	OH/UG	C.P.	#6-2/0	#6-2/0	Lever	4 $\frac{7}{8}$	10	18 $\frac{1}{2}$	2	¼, ½	¼
UAP3505-XL-TG-HSP	Aluminum	5	OH/UG	C.P.	#6-2/0	#6-2/0	Lever	4 $\frac{7}{8}$	10	18 $\frac{1}{2}$	2	¼, ½	¼

125 Amps | Ringless | Lever Bypass | Single Position | 3Ø4W

Catalog Number	Material	Terminal	Service	Hub	Connectors CU/AL		Bypass	Dimensions			Knockouts		
					Line	Load		D"	W"	H"	1	2	3
U3506-XL-TG-HSP	Steel	7	OH/UG	C.P.	#6-2/0	#6-2/0	Lever	4 $\frac{7}{8}$	10	18 $\frac{1}{2}$	2	¼, ½	¼
UAP3506-XL-TG-HSP	Aluminum	7	OH/UG	C.P.	#6-2/0	#6-2/0	Lever	4 $\frac{7}{8}$	10	18 $\frac{1}{2}$	2	¼, ½	¼

Notes

- **Hubs:** For proper hub selection, see the hub suffix chart on the accessories page.
- **Lever Bypass:** The lever supplies clamping action and operates bypass device.
- **Connectors:** Extruded aluminum connectors are tin plated.



Please consult serving utility for their requirements prior to ordering or installing, as specifications and approvals vary by utility, and may require local electrical inspector approval. All installations must be installed by a licensed electrician and must comply with all national and local codes, laws and regulations. Milbank reserves the right to make changes in specifications and features shown without notice or obligation.

Single Position Lever Bypass

200 Amps | 4 & 5 Terminal | Ringless | 600 VAC

1 1
200 AMPS
LEVER BYPASS
SOCKETS



U9801-X-HSP

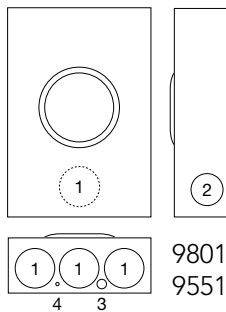

U9550-RRL-QG-HSP

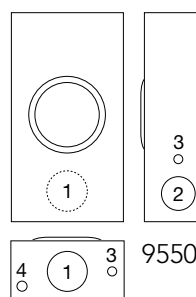

U9551-X-QG-HSP

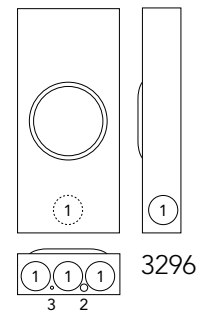

200 Amps | Ringless | Lever Bypass | Single Position | 1Ø3W

Catalog Number	Material	Terminal	Service	Hub	Connectors CU/AL	Bypass	Dimensions			Knockouts				
							D"	W"	H"	1	2	3	4	
U9801-X-HSP	Steel	4	OH/UG	C.P.	#6-350	Lever	4 ⁷ / ₈	13	19	3	2 ¹ / ₂	1 ¹ / ₄ , 1 ¹ / ₂	1 ¹ / ₄	
U9550-RRL-QG-HSP	Steel	5	OH	H.O.	#6-350	Lever	4 ⁷ / ₈	10	18 ¹ / ₂	3	2 ¹ / ₂	1 ¹ / ₄ , 1 ¹ / ₂	1 ¹ / ₄	
U9551-X-QG-HSP	Steel	5	OH/UG	C.P.	#6-350	Lever	4 ⁷ / ₈	13	19	3	2 ¹ / ₂	1 ¹ / ₄ , 1 ¹ / ₂	1 ¹ / ₄	
UAP9551-X-QG-HSP	Aluminum	5	OH/UG	C.P.	#6-350	Lever	4 ⁷ / ₈	13	19	3	2 ¹ / ₂	1 ¹ / ₄ , 1 ¹ / ₂	1 ¹ / ₄	
U3296-X-HSP	Steel	5	OH/UG	C.P.	3 ⁸ / ₁₆ "x16 Studs	Lever	4 ⁷ / ₈	13	28 ¹ / ₄	3	1 ¹ / ₄ , 1 ¹ / ₂	1 ¹ / ₄	—	
UAP3296-X-HSP	Aluminum	5	OH/UG	C.P.	3 ⁸ / ₁₆ "x16 Studs	Lever	4 ⁷ / ₈	13	28 ¹ / ₄	3	1 ¹ / ₄ , 1 ¹ / ₂	1 ¹ / ₄	—	

Notes

- **Hubs:** For proper hub selection, see the hub suffix chart on the accessories page.
- **Lever Bypass:** The lever supplies clamping action and operates bypass device.
- **Fifth Terminal:** For field installed fifth terminal on the **U9801**, order **K3866**.
- **Connectors:** Extruded aluminum connectors are tin plated. For the **U3296-X** stud-type unit, order connector kits separately. Order two kits to cover both line and load side: **K1539** (350 kcmil) or **K1540** (600 kcmil.) See accessories page.

Please consult serving utility for their requirements prior to ordering or installing, as specifications and approvals vary by utility, and may require local electrical inspector approval. All installations must be installed by a licensed electrician and must comply with all national and local codes, laws and regulations. Milbank reserves the right to make changes in specifications and features shown without notice or obligation.



Single Position Lever Bypass

200 Amps | 7 Terminal | Ringless | 600 VAC

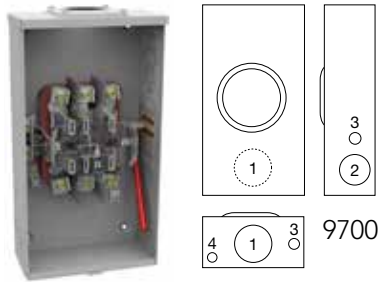

U9700-RRL-QG-HSP

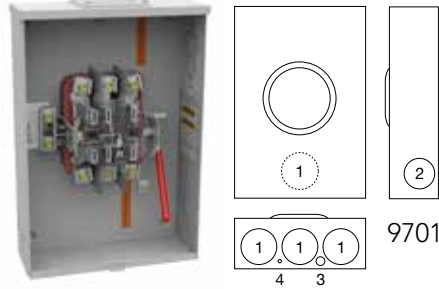

U9701-X-QG-HSP

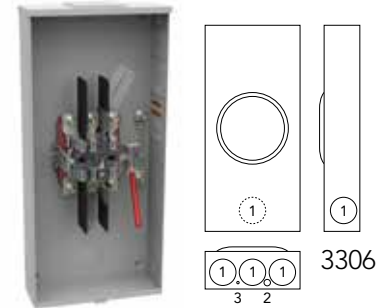

U3306-X-HSP

200 Amps | 7 Terminal | Ringless | Lever Bypass | Single Position | 3Ø4W

Catalog Number	Material	Terminal	Service	Hub	Connectors CU/AL	Bypass	Dimensions			Knockouts			
							D"	W"	H"	1	2	3	4
U9700-RRL-QG-HSP	Steel	7	OH	H.O.	#6-350	Lever	4 ⁷ / ₈	10	18 ¹ / ₂	3	2 ¹ / ₂	³ / ₄	¹ / ₄ , ¹ / ₂
UAP9700-RRL-QG-HSP	Aluminum	7	OH	H.O.	#6-350	Lever	4 ⁷ / ₈	10	18 ¹ / ₂	3	2 ¹ / ₂	³ / ₄	¹ / ₄ , ¹ / ₂
U9701-X-QG-HSP	Steel	7	OH/UG	C.P.	#6-350	Lever	4 ⁷ / ₈	13	19	3	2 ¹ / ₂	¹ / ₄ , ¹ / ₂	¹ / ₄
UAP9701-X-QG-HSP	Aluminum	7	OH/UG	C.P.	#6-350	Lever	4 ⁷ / ₈	13	19	3	2 ¹ / ₂	¹ / ₄ , ¹ / ₂	¹ / ₄
U3306-X-HSP	Steel	7	OH/UG	C.P.	³ / ₈ " x 16 Studs	Lever	4 ⁷ / ₈	13	28 ¹ / ₄	3	¹ / ₄ , ¹ / ₂	¹ / ₄	—
UAP3306-X-HSP	Aluminum	7	OH/UG	C.P.	³ / ₈ " x 16 Studs	Lever	4 ⁷ / ₈	13	28 ¹ / ₄	3	¹ / ₄ , ¹ / ₂	¹ / ₄	—

Notes

- **Hubs:** For proper hub selection, see the hub suffix chart on the accessories page.
- **Lever Bypass:** The lever supplies clamping action and operates bypass device.
- **Isolated Neutral:** For field-installed isolated neutral for **U9701**, order **K1047**.
- **Connectors:** Extruded aluminum connectors are tin plated. For the **U3306** stud-type unit, order connector kits separately. Order 2 kits to cover both line and load side: **K3082** (350 kcmil) or **K3441** (600 kcmil.) See accessories page.



Please consult serving utility for their requirements prior to ordering or installing, as specifications and approvals vary by utility, and may require local electrical inspector approval. All installations must be installed by a licensed electrician and must comply with all national and local codes, laws and regulations. Milbank reserves the right to make changes in specifications and features shown without notice or obligation.

Single Position Lever Bypass

320 Amps | 4 Terminal | Ringless | 600 VAC

1 3
320 AMPS
LEVER BYPASS
SOCKETS



U4363-X-HSP U6273-X-HSP U6272-X-HSP U1129-O-K3L-K2L-HSP U1797-O-K3L-K2L-HSP U2124-O-HSP

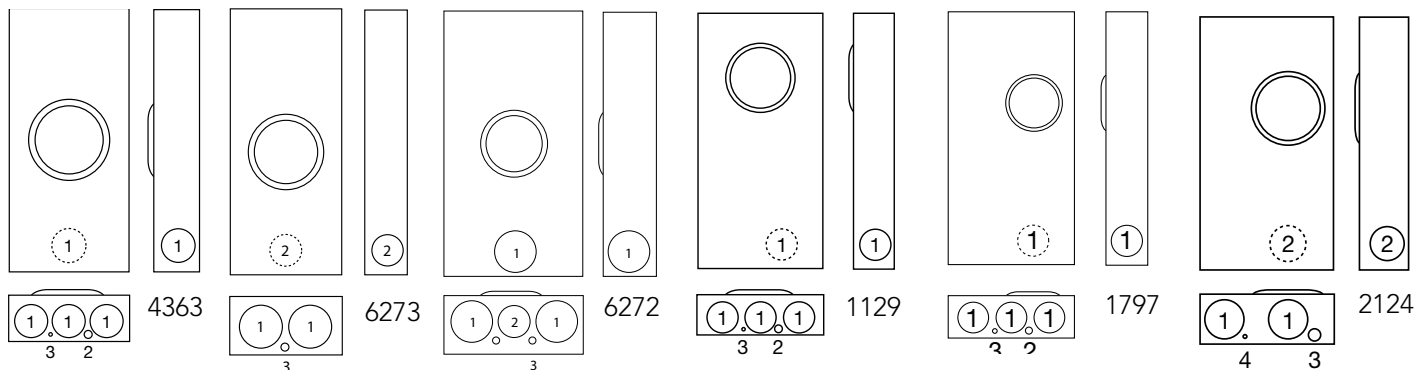

320 Amps | 4 Terminal | Ringless | Lever Bypass | Single Position | 1Ø3W

Catalog Number	Material	Service	Hub	Connectors CU/AL		Dimensions			Knockouts			
				Line	Load	D"	W"	H"	1	2	3	4
U4363-X-HSP	Steel	OH	C.P.	3/8" x 16 Studs	3/8" x 16 Studs	4 ²⁷ / ₃₂	13	28 ¹ / ₄	3	1/2	1/4	—
U6273-X-HSP	Steel	OH	C.P.	3/8" x 16 Studs	3/8" x 16 Studs	6	13	28 ¹ / ₄	4	3	—	—
U6272-X-HSP	Steel	OH/UG	Blank	3/8" x 16 Studs	3/8" x 16 Studs	6	16	28 ¹ / ₄	4	3	—	—
U1129-O-K3L-K2L-HSP	Steel	UG	Blank	(1) #4-600 or (2) 1/0-250	(2) #6-350	4 ⁷ / ₈	15	30	3	1/2	1/4	—
U1797-O-K3L-K2L-HSP	Steel	UG	Blank	(1) #4-600 or (2) 1/0-250	(2) #6-350	4 ²⁷ / ₃₂	15	30	3	1/2	1/4	—
U2124-O-HSP	Steel	UG	Blank	3/8" x 16 Studs	3/8" x 16 Studs	5 ³ / ₄	16	30	4	3 ¹ / ₂	1	1/4
UAP2124-O-HSP	Aluminum	UG	Blank	3/8" x 16 Studs	3/8" x 16 Studs	5 ³ / ₄	16	30	4	3 ¹ / ₂	1	1/4

Notes

- **Hubs:** For proper hub selection, see the hub suffix chart on the accessories page.
- **Lever Bypass:** The lever supplies clamping action and operates bypass device.
- **Connectors:** Extruded aluminum connectors are tin plated. Order two connector kits to cover both line and load. See accessories page.

Please consult serving utility for their requirements prior to ordering or installing, as specifications and approvals vary by utility, and may require local electrical inspector approval. All installations must be installed by a licensed electrician and must comply with all national and local codes, laws and regulations. Milbank reserves the right to make changes in specifications and features shown without notice or obligation.



Lever Bypass Single Position

320 Amps | 5 Terminal | Ringless | 600 VAC

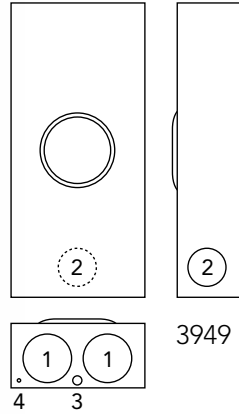

3949

U3949-X-HSP

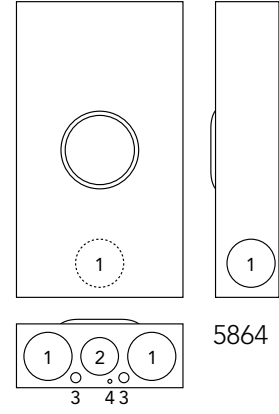

5864

U5864-X-HSP

320 Amps | 5 Terminal | Ringless | Lever Bypass | Single Position | 1Ø3W

Catalog Number	Material	Terminal	Service	Hub	Connectors CU/AL	Bypass	Dimensions			Knockouts			
							D"	W"	H"	1	2	3	4
U3949-X-HSP	Steel	5	OH	C.P.	3/8" x 16 Studs	Lever	6	13	28 1/4	4	3	1/4, 1/2	1/4
UAP3949-X-HSP	Aluminum	5	OH	C.P.	3/8" x 16 Studs	Lever	6	13	28 1/4	4	3	1/4, 1/2	1/4
U5864-X-HSP	Steel	5	OH/UG	C.P.	3/8" x 16 Studs	Lever	6	16	28 1/4	4	3	1/4, 1/2	1/4
UAP5864-X-HSP	Aluminum	5	OH/UG	C.P.	3/8" x 16 Studs	Lever	6	16	28 1/4	4	3	1/4, 1/2	1/4

Notes

- **Hubs:** For proper hub selection, see the hub suffix chart on the accessories page.
- **Lever Bypass:** The lever supplies clamping action and operates bypass device.
- **Connectors:** Extruded aluminum connectors are tin plated. Order two connector kits to cover both line and load. See accessories page.
- **U5864:** The U5864 will not accept twin lugs (the K1540 connector will accept 2 conductors 1/0–250 max).



Please consult serving utility for their requirements prior to ordering or installing, as specifications and approvals vary by utility, and may require local electrical inspector approval. All installations must be installed by a licensed electrician and must comply with all national and local codes, laws and regulations. Milbank reserves the right to make changes in specifications and features shown without notice or obligation.

Lever Bypass Single Position

320 Amps | 7 Terminal | Ringless | 600 VAC

15
320 AMPS
LEVER BYPASS
SOCKETS



U3566-X-HSP

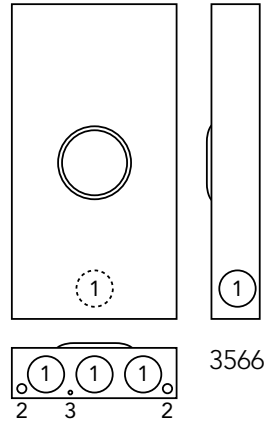

U2120-O-HSP

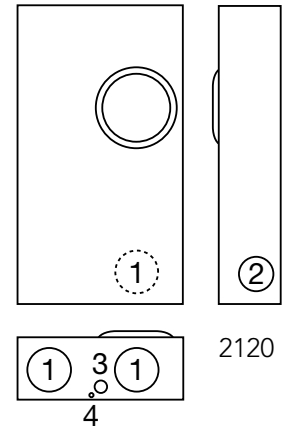

320 Amps | 7 Terminal | Ringless | Lever Bypass | Single Position | 3Ø4W

Catalog Number	Material	Terminal	Service	Hub	Connectors CU/AL	Bypass	Dimensions			Knockouts			
							D"	W"	H"	1	2	3	4
U3566-X-HSP	Steel	7	OH/UG	C.P.	½" x 13 Studs	Lever	6	20¼	38¾	4	3	¼, ½	¼
UAP3566-X-HSP	Aluminum	7	OH/UG	C.P.	½" x 13 Studs	Lever	6	20¼	38¾	4	3	¼, ½	¼
U2120-O-HSP	Steel	7	UG	Blank	¾" x 16 Studs	Lever	6½	17¾	31¾	4	3	1	¼

Notes

- **Hubs:** For proper hub selection, see the hub suffix chart on the accessories page.
- **Lever Bypass:** The lever supplies clamping action and operates bypass device.
- **Connectors:** Extruded aluminum connectors are tin plated. Order two connector kits to cover both line and load. See accessories page.
- **U3566:** The U3566 will accept an isolated neutral kit K6024.
- 1/2" stud lug kits **K4223** two position #6-350 kcmil or **K4200** for a single wire #4-600 or (2) 1/0-250 kcmil

Please consult serving utility for their requirements prior to ordering or installing, as specifications and approvals vary by utility, and may require local electrical inspector approval. All installations must be installed by a licensed electrician and must comply with all national and local codes, laws and regulations. Milbank reserves the right to make changes in specifications and features shown without notice or obligation.



1 6
600 AMPS
BOLT-IN BYPASS
SOCKETS

Bolt-In Bypass Single Position

600 Amps (480A Cont.) | 7 Terminal | Ringless | *FPL approved only*



U4667-X-8528

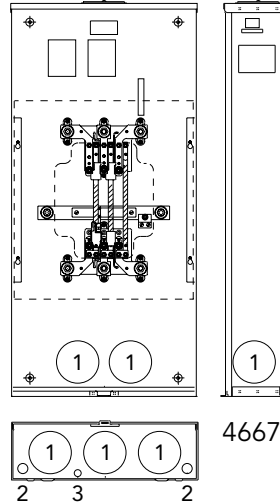

4667

600 Amps(480A Cont.) | Ringless | Bolt-In Bypass | Single Position | **FPL Only**

Catalog Number	Approved Utilities	Material	Terminal	Hub	Ground Lug	Dimensions			Knockouts		
						D"	W"	H"	1	2	3
U4667-X-8528	FP&L	Steel	7	C.P.	1/0-2/0	6	20¼	43	4	½,¾	¼
UA4667-X-8529	FP&L	Aluminum	7	C.P.	1/0-2/0	6	20¼	43	4	½,¾	¼
U4667-XT-9526	FP&L	Steel	7	(2) C.P.	1/0-2/0	6	20¼	43	4	½,¾	¼
UA4667-XT-9527	FP&L	Aluminum	7	(2) C.P.	1/0-2/0	6	20¼	43	4	½,¾	¼

Notes

- **Hubs:** The -X unit is supplied with a large closing plate in the top. The -XT units are supplied with 2 large closing plates in the top. For proper hub selection, see the hub suffix chart on the accessories page.
- **Isolated Neutral Kit:** For an isolated neutral on the 7-terminal sockets, order catalog number **Z708312-MO**.
- **Connectors:** The 4-terminal units require a total of 5 connectors. The 7-terminal units require a total of 8 connectors. The 7-terminal units are supplied with two ground lugs. Order line and load connectors as extra. See chart on next page for ordering information.
- **Bolt-In Bypass:** These units offer a provision for a utility-supplied bolt-in bypass.



Please consult serving utility for their requirements prior to ordering or installing, as specifications and approvals vary by utility, and may require local electrical inspector approval. All installations must be installed by a licensed electrician and must comply with all national and local codes, laws and regulations. Milbank reserves the right to make changes in specifications and features shown without notice or obligation.

Bolt-In Bypass Single Position

Connector Kits

17

BOLT-IN BYPASS
CONNECTOR KITS



Z703916-AC

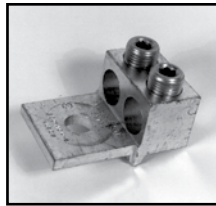

Z703918-AC



Z703919-AC

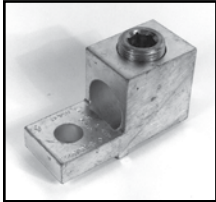

Z703921-AC



Z705420-AC



Z705456-AC

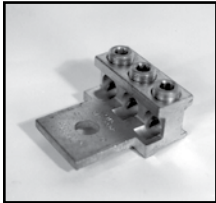

Z708145-AC

Bolt-on type lugs for Milbank stud type meter mounting devices are made of 6061-T6 aluminum to provide high strength and high conductivity. All lugs are tinplated to ensure low contact resistance and to reduce corrosion. Allen or hex head pressure screws are furnished to provide excellent conductor spread for maximum binding action with the lug.

4 Terminal, 1Ø3W Connector Kits

Catalog Number	Wire Range	Type	Wire Entry
Z703917-AC	#6-350	Twin	Side
Z704693-AC	#2-500	Twin	Side
Z705456-AC	#6-350	Twin	Rear
Z705420-AC	#6-350	Quad	Rear

7 Terminal, 3Ø4W Connector Kits

Catalog Number	Wire Range	Type	Wire Entry
Z703916-AC	3/0-800	Single	Side
Z703921-AC	3/0-800	Single	Front
Z703918-AC	#4-350	Twin	Front
Z703919-AC	#6-350	Twin	Side
Z704693-AC	#2-500	Twin	Side
Z704694-AC	#4-500	Twin	Front
Z708145-AC	#6-250	Triple	Front

Please consult serving utility for their requirements prior to ordering or installing, as specifications and approvals vary by utility, and may require local electrical inspector approval. All installations must be installed by a licensed electrician and must comply with all national and local codes, laws and regulations. Milbank reserves the right to make changes in specifications and features shown without notice or obligation.



100-200 Amps | 4 Terminal | Ringless | 120/240 VAC



U5842-RL-150-HSP

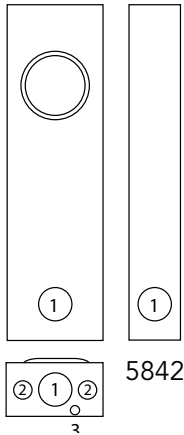

UAP5024-XL-FMG

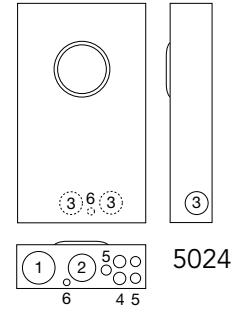

100-200 Amps | 4 Terminal | Ringless | Meter Main | 1Ø3W

Catalog Number	Material	Service	Hub	Connectors CU/AL - Line		Dimensions			Knockouts		
				Line	Load	D"	W"	H"	1	2	3
U5842-RL-100-HSP	Steel	OH	C.P.	#6-350	CB	4½	14	30	2	1¼	¼
U5842-RL-150-HSP	Steel	OH	C.P.	#6-350	CB	4½	14	30	2	1¼	¼
U5842-RL-200-HSP	Steel	OH	C.P.	#6-350	CB	4½	14	30	2	1¼	¼

200 Amps | 4 Terminal | Ringless | Meter Main Load Center | 1Ø3W

Catalog Number	Material	Service	Hub	Connectors CU/AL - Line		Dimensions			Knockouts					
				Line	Load	D"	W"	H"	1	2	3	4	5	6
UAP5024-XL-FMG*	Aluminum	OH/UG	C.P.	#6-350	CB	4½	14⅞	24	3	2½	2	1	½,¾	¼,½

Notes

- * **Wireway:** Provided with underground pull section wireway with removable cover.
- **UAP5024 Bussing:** Load side bus bars and circuit breaker interior are made from plated copper.
- **Breakers:** UAP5024 Breaker section has provision for six double pole "plug-in" type circuit breakers. All circuit breakers will be parallel. To comply with NEC wire bending space requirements the maximum breaker amperage is 200 Amps restricted to 3/0 copper conductor.

Breaker Chart for UAP5024

Manufacturer	Compatible Models	AIC Rating
Siemens	QN, QNR, QP	10K
Cutler-Hammer	BR, HQP, QPGF	10K
G.E.	TQL, THQL-GF	10K
Square D	Homeline	10K



Please consult serving utility for their requirements prior to ordering or installing, as specifications and approvals vary by utility, and may require local electrical inspector approval. All installations must be installed by a licensed electrician and must comply with all national and local codes, laws and regulations. Milbank reserves the right to make changes in specifications and features shown without notice or obligation.

Meter Main with Load Center

100-200 Amps | 4 Terminal | Ringless | 120/240 VAC

19
100-200 AMPS
METER MAIN
WITH LOAD
CENTER



U6266-XTL-100-HSP

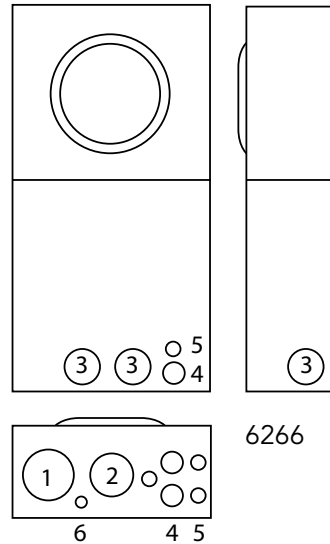

6266

100-200 Amps | 4 Terminal | Ringless | Meter Main | 1Ø3W

Catalog Number	Material	Service	Hub	Connectors CU/AL - Line	Dimensions			Knockouts					
					D"	W"	H"	1	2	3	4	5	6
U6266-XTL-100-HSP	Steel	OH/UG	(2) C.P.	#6-350	4½	14⅞	30	3	2½	2	½	¾	½
U6266-XTL-150-HSP	Steel	OH/UG	(2) C.P.	#6-350	4½	14⅞	30	3	2½	2	½	¾	½
U6266-XTL-200-HSP	Steel	OH/UG	(2) C.P.	#6-350	4½	14⅞	30	3	2½	2	½	¾	½

Notes

- **Hubs:** Supplied with two closing plates packed inside. Order hubs as a separate item. For proper hub selection, refer to the hub suffix chart on the accessories page.
- **Fifth Terminal:** For field installed fifth terminal, order **K5T**.
- **Breakers:** 22KAIC main breakers factory installed
- **Main Breaker:** also available with 100-150 Amps breakers, consult factory.
- **Sub Feed Lugs:** #6-350 sub feed lugs provided on 10 circuit interior. **Not available on 20 circuit interior.**
- See accessories page for generator interlock kits.

Please consult serving utility for their requirements prior to ordering or installing, as specifications and approvals vary by utility, and may require local electrical inspector approval. All installations must be installed by a licensed electrician and must comply with all national and local codes, laws and regulations. Milbank reserves the right to make changes in specifications and features shown without notice or obligation.

MEG
APPROVED



Meter Main & Meter Main w/ Load Center

320 Amps | 4 Terminal | Ringless | 120/240 VAC

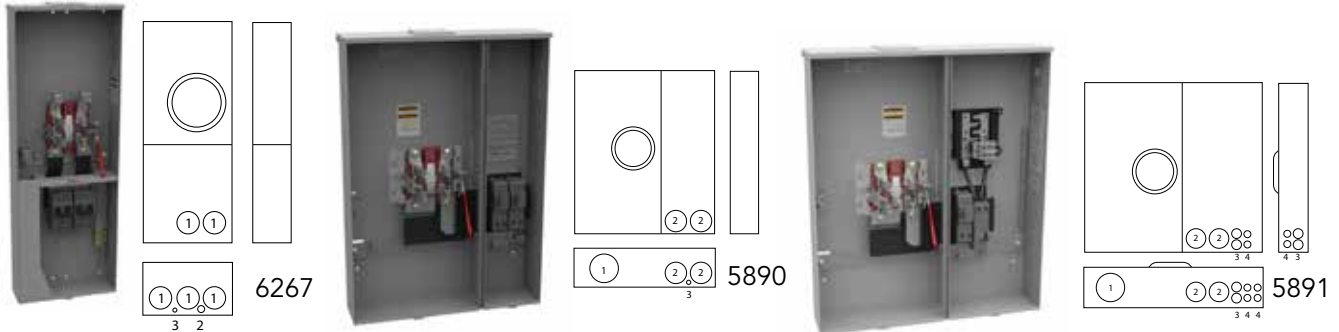

U6267-X-2/200-HSP

U5890-X-2/200-HSP

U5891-X-2/200-HSP

320 Amps | 4 Terminal | Ringless | Meter Main | 1Ø3W | Lever Bypass

Catalog Number	Material	Service	Hub	Connectors CU/AL - Line		Dimensions			Knockouts		
				Line	Load	D"	W"	H"	1	2	3
*U6267-X-HSP	Steel	OH/UG	C.P.	3/8" x 16 Studs	—	6	15	42½	4	2½	.312
U6267-X-2/150-HSP	Steel	OH/UG	C.P.	3/8" x 16 Studs	CB	6	15	42½	4	2½	.312
U6267-X-2/200-HSP	Steel	OH/UG	C.P.	3/8" x 16 Studs	CB	6	15	42½	4	2½	.312

320 Amps | 4 Terminal | Ringless | Meter Main | 1Ø3W | Lever Bypass

Catalog Number	Material	Service	Hub	Connectors CU/AL - Line		Dimensions			Knockouts		
				Line	Load	D"	W"	H"	1	2	3
U5890-X-2/150-HSP	Steel	OH/UG	C.P.	3/8" x 16 Studs	CB	6	24½	35	4	2½	.312
U5890-X-2/200-HSP	Steel	OH/UG	C.P.	3/8" x 16 Studs	CB	6	24½	35	4	2½	.312

320 Amps | 4 Terminal | Ringless | Meter Main w/ Load Center | 1Ø3W | Lever Bypass

Catalog Number	Material	Service	Hub	Connectors CU/AL - Line		Dimensions			Knockouts			
				Line	Load	D"	W"	H"	1	2	3	4
U5891-X-2/200-MLK-HSP	Steel	OH/UG	C.P.	3/8" x 16 Studs	CB	6	29½	35	4	2½	1	¾

Notes

- **HSP:** Has a stainless steel hasp
- **Short Circuit Current Withstand Rating:** 22K AIC standard.
- **Breakers:** Units come with main breakers. *U6267-X-HSP breaker sold separately.
- **Fifth Terminal:** For field mounted fifth terminal order catalog number **K3865**.



Please consult serving utility for their requirements prior to ordering or installing, as specifications and approvals vary by utility, and may require local electrical inspector approval. All installations must be installed by a licensed electrician and must comply with all national and local codes, laws and regulations. Milbank reserves the right to make changes in specifications and features shown without notice or obligation.

Meter Socket with Main

400 Amps | 4 & 7 Terminal | Ringless | 480 VAC

21
METER SOCKET
WITH MAIN

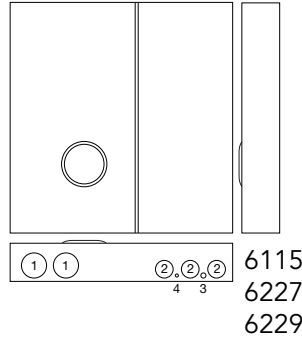

U6115-X-2/200-K7L

400 Amps Meter Main | 7 Terminal | 3Ø4W | Ringless | 480 VAC

Catalog Number	Service	Hub	Connectors CU/AL	Dimensions			Knockouts			
			Line	D"	W"	H"	1	2	3	4
U6115-X-2/200-K7L-HSP	OH/UG	C.P.	#4-600kcmil or (2) 1/0 - 250	7	34¼	34	4	2½	½	¼

400 Amps Meter Main | 4 Terminal | 1Ø3W | Ringless | 480 VAC

Catalog Number	Service	Hub	Connectors CU/AL	Dimensions			Knockouts			
			Line	D"	W"	H"	1	2	3	4
U6227-X-400-K3L-HSP	OH/UG	C.P.	#4-600kcmil or (2) 1/0 - 250	6	36¼	34	4	2½	½	¼

400 Amps Meter Main | 3 Terminal | 3Ø4W | 480 VAC

Catalog Number	Service	Hub	Connectors CU/AL	Dimensions			Knockouts			
			Line	D"	W"	H"	1	2	3	4
U6229-X-400-K3L-HSP	OH/UG	C.P.	#4-600kcmil or (2) 1/0 - 250	6	36¼	34	4	2½	½	¼

Specifications

- AIC Rating: **22K AIC at 240V**. And 10K AIC at **480V**
- 300 Amps breaker: **U6227 and U6229 only** can be installed from the factory (upon request)

Please consult serving utility for their requirements prior to ordering or installing, as specifications and approvals vary by utility, and may require local electrical inspector approval. All installations must be installed by a licensed electrician and must comply with all national and local codes, laws and regulations. Milbank reserves the right to make changes in specifications and features shown without notice or obligation.



Multi-Position Sockets

100 Amps | 4 Terminal | Ringless | 300 VAC



U3492-XL-HSP

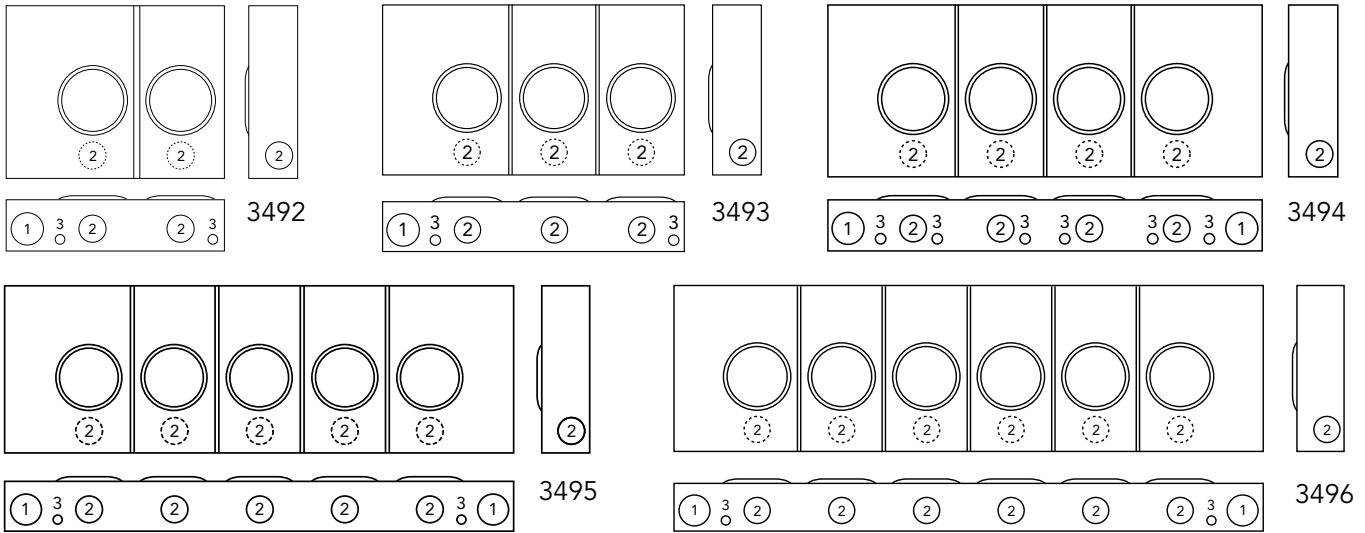

100 Amps per Position | 4 Terminal | Ringless | Multi-Position | 1Ø3W

Catalog Number	Positions	Hub	Connectors CU/AL		Bypass	Dimensions			Knockouts		
			Line	Load		D"	W"	H"	1	2	3
U3492-XL-HSP	2	C.P.	#6-350	#6-2/0	None	4½	20⅞	16	2½	2	¼, ½
U3493-XL-HSP	3	C.P.	#6-350	#6-2/0	None	4½	28½	16	2½	2	¼, ½
U3494-XL-HSP	4	C.P.	#6-350	#6-2/0	None	4½	40⅞	16	2½	2	¼, ½
U3495-XL-HSP	5	C.P.	#6-350	#6-2/0	None	4½	48⅞	16	2½	2	¼, ½
U3496-XL-HSP	6	C.P.	#6-350	#6-2/0	None	4½	57⅞	16	2½	2	¼, ½

Notes

- **Hubs:** Units are supplied with closing plate at each end. For proper hub selection, see the hub suffix chart on the accessories page.
- **Fifth Terminal Kit:** For field-mounted fifth terminal, order catalog number **5T8K2** in the 6 o'clock position.
- **Connectors:** Extruded aluminum connectors are tin plated. Bonding ground is furnished.
- **Bussing:** Units include ⅝" x 1 aluminum bussing.



Please consult serving utility for their requirements prior to ordering or installing, as specifications and approvals vary by utility, and may require local electrical inspector approval. All installations must be installed by a licensed electrician and must comply with all national and local codes, laws and regulations. Milbank reserves the right to make changes in specifications and features shown without notice or obligation.

Multi-Position Sockets

150 Amps | 4 Terminal | Ringless | 300 VAC

23
150 AMPS
MULTI-POSITION
SOCKETS



U1232-X-HSP

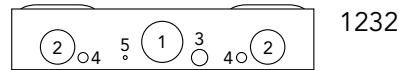
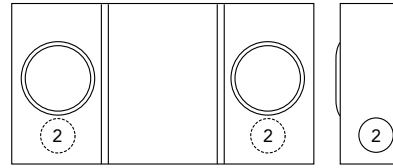

1232

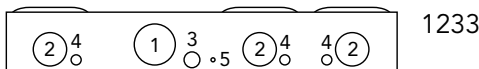
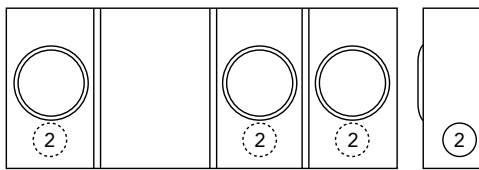

1233

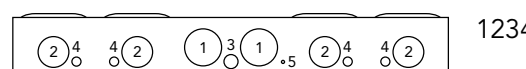
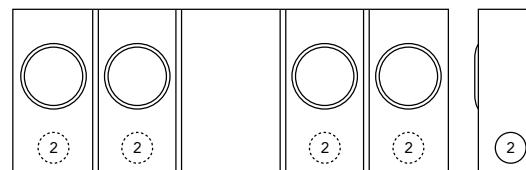

1234

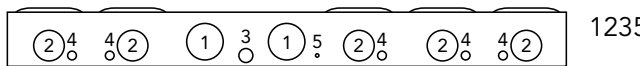
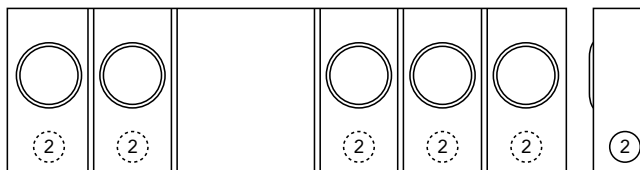

1235

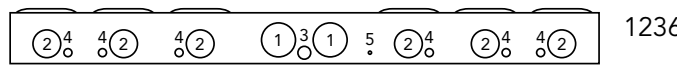
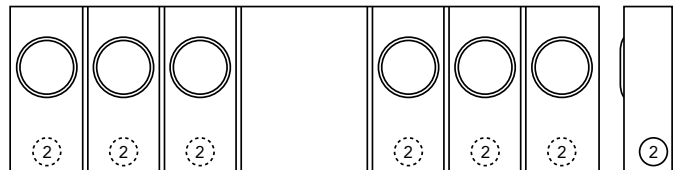

1236

150 Amps per Position | 4 Terminal | Ringless | Multi-Position | 1Ø3W

Catalog Number	Positions	Hub	Connectors CU/AL		Bypass	Dimensions			Knockouts				
			Line	Load		D"	W"	H"	1	2	3	4	5
U1232-X-HSP	2	C.P.	Studs	#6-350	None	5½	26½	14	3	2½	1	½	¼
U1233-X-HSP	3	C.P.	Studs	#6-350	None	5½	34⅙	14	3	2½	1	½	¼
U1234-X-HSP	4	C.P.	Studs	#6-350	None	5½	42⅞	16	3	2½	1	½	¼
U1235-X-HSP	5	C.P.	Studs	#6-350	None	5½	54⅞	16	3	2½	1	½	¼
U1236-X-HSP	6	C.P.	Studs	#6-350	None	5½	63⅙	18	3	2½	1	½	¼

Notes

- **Hubs:** Units are supplied with closing plates. For proper hub selection, see the hub suffix chart on the accessories page.
- **Fifth Terminal Kit:** For field-mounted fifth terminal, order catalog number **K5T**.
- **Connectors:** Line wire section is supplied with ¾" -16 studs with hex head nuts and captive Belleville washers. Order connector kits separately. One kit per unit. See accessories page.

Please consult serving utility for their requirements prior to ordering or installing, as specifications and approvals vary by utility, and may require local electrical inspector approval. All installations must be installed by a licensed electrician and must comply with all national and local codes, laws and regulations. Milbank reserves the right to make changes in specifications and features shown without notice or obligation.

MEG
APPROVED



MILBANK
ENERGY AT WORK

24

200 AMPS
MULTI-POSITION
SOCKETS

Multi-Position Sockets

200 Amps | 4 Terminal | Ringless | 300 VAC



U1252-X-HSP

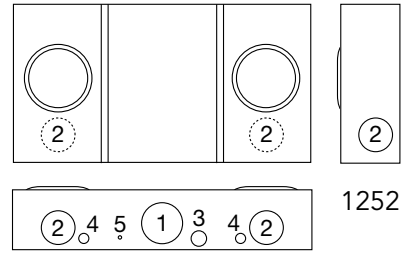

1252

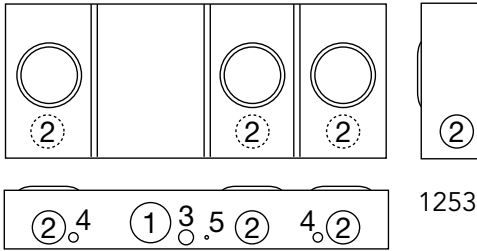

1253

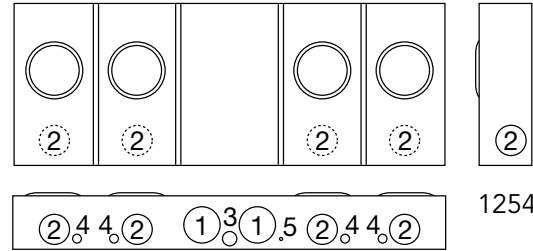

1254

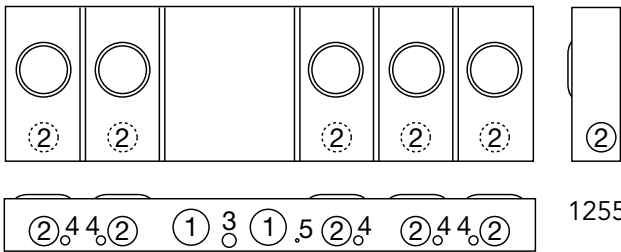

1255

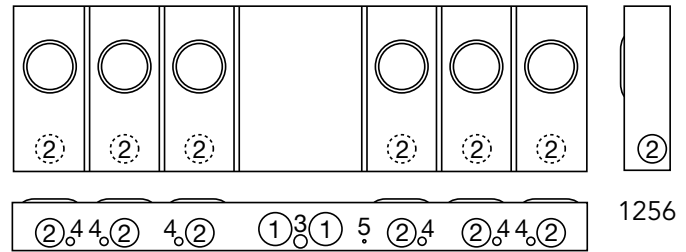

1256

200 Amps per Position | 4 Terminal | Ringless | Multi-Position | 1Ø3W

Steel Catalog Number	Aluminum Catalog Number	Positions	Hub	Connectors CU/AL		Dimensions			Knockouts				
				Line	Load	D"	W"	H"	1	2	3	4	5
U1252-X-HSP	UAP1252-X-HSP	2	C.P.	Studs	#6-350	5 ¹ / ₈	26 ¹ / ₂	14	3	2 ¹ / ₂	1	1 ¹ / ₂	1 ¹ / ₄
U1253-X-HSP	UAP1253-X-HSP	3	C.P.	Studs	#6-350	5 ¹ / ₈	34 ¹¹ / ₁₆	14	3	2 ¹ / ₂	1	1 ¹ / ₂	1 ¹ / ₄
U1254-X-HSP	UAP1254-X-HSP	4	C.P.	Studs	#6-350	5 ¹ / ₈	42 ⁷ / ₈	16	3	2 ¹ / ₂	1	1 ¹ / ₂	1 ¹ / ₄
U1255-X-HSP	UAP1255-X-HSP	5	C.P.	Studs	#6-350	5 ¹ / ₈	54 ⁷ / ₈	16	3	2 ¹ / ₂	1	1 ¹ / ₂	1 ¹ / ₄
U1256-X-HSP	UAP1256-X-HSP	6	C.P.	Studs	#6-350	5 ¹ / ₈	63 ¹ / ₁₆	18	3	2 ¹ / ₂	1	1 ¹ / ₂	1 ¹ / ₄

Notes

- **Hubs:** Units are supplied with closing plates. For proper hub selection, see the hub suffix chart on the accessories page.
- **Fifth Terminal Kit:** For field-mounted fifth terminal, order catalog number **K5T**.
- **Connectors:** Line wire section is supplied with 3/8"-16 studs with hex head nuts and captive Belleville washers. Order connector kits separately. One kit per unit. See accessories page



Please consult serving utility for their requirements prior to ordering or installing, as specifications and approvals vary by utility, and may require local electrical inspector approval. All installations must be installed by a licensed electrician and must comply with all national and local codes, laws and regulations. Milbank reserves the right to make changes in specifications and features shown without notice or obligation.

HD Lever Multi-Position Sockets

200 Amps | 5 Terminal | Ringless | 600 VAC

25
200 AMP
HD LEVER
MULTI-POSITION
SOCKETS

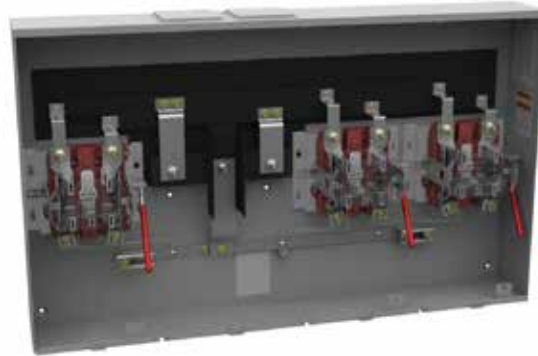

U2873-XT-HSP

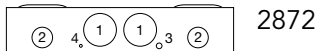
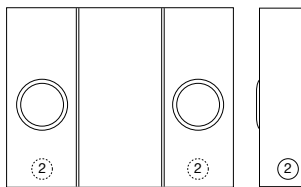

2872

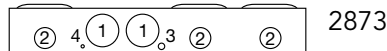
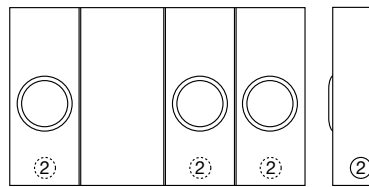

2873

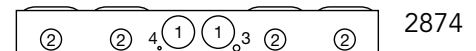
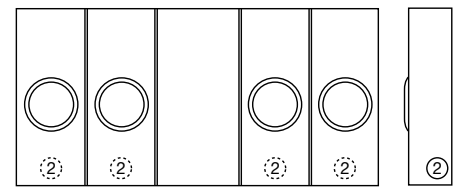

2874

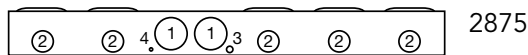
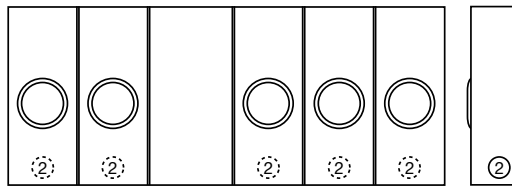

2875

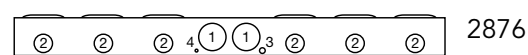
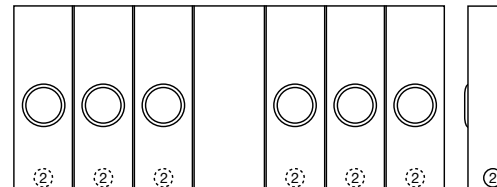

2876

200 Amps per Position | 5 Terminal | Ringless | Multi-Position | 1Ø3W

Catalog Number	Positions	Hub	Connectors CU/AL		Bypass	Dimensions			Knockouts			
			Line	Load		D"	W"	H"	1	2	3	4
U2872-XT-HSP	2	(2) C.P.	3/8" -16 Studs	#6-350	Lever	6	32 1/8	25 1/4	4	2 1/2	1/4, 1/2	1/4
U2873-XT-HSP	3	(2) C.P.	3/8" -16 Studs	#6-350	Lever	6	42 3/16	25 1/4	4	2 1/2	1/4, 1/2	1/4
U2874-XT-HSP	4	(2) C.P.	3/8" -16 Studs	#6-350	Lever	6	52 1/4	25 1/4	4	2 1/2	1/4, 1/2	1/4
U2875-XT-HSP	5	(2) C.P.	3/8" -16 Studs	#6-350	Lever	6	62 5/16	25 1/4	4	2 1/2	1/4, 1/2	1/4
U2876-XT-HSP	6	(2) C.P.	3/8" -16 Studs	#6-350	Lever	6	72 5/8	31 1/4	4	2 1/2	1/4, 1/2	1/4

Notes

- **Hubs:** Units are supplied with two closing plates. For proper hub selection, see the hub suffix chart on the accessories page.
- **Bypass:** Lever supplies clamping action on meter spades and also operates bypass device.
- **Connectors:** For line side connector kits, order separately. Order one kit per unit. See accessories page.

Please consult serving utility for their requirements prior to ordering or installing, as specifications and approvals vary by utility, and may require local electrical inspector approval. All installations must be installed by a licensed electrician and must comply with all national and local codes, laws and regulations. Milbank reserves the right to make changes in specifications and features shown without notice or obligation.



HD Lever Multi-Position Sockets

200 Amps | 7 Terminal | Ringless | 600 VAC

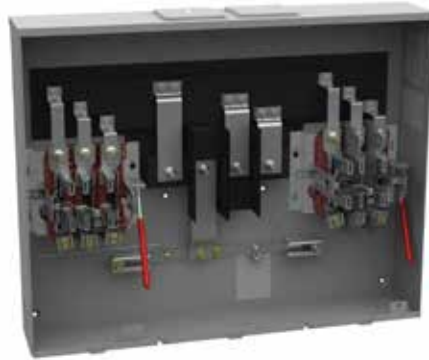

U2732-XT-HSP

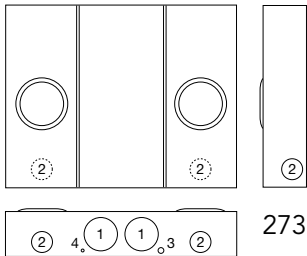

2732

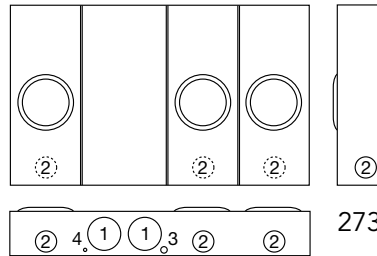

2733

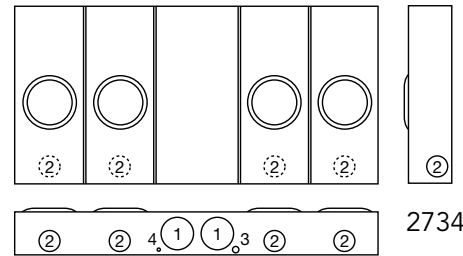

2734

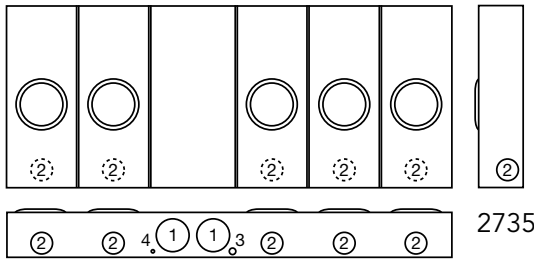

2735

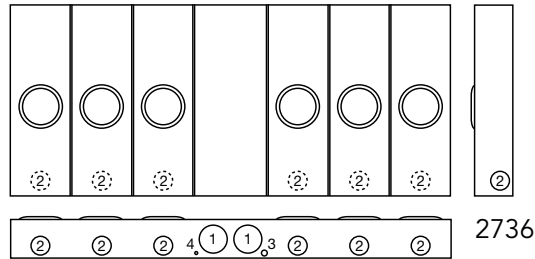

2736

200 Amps per Position | 7 Terminal | Ringless | Multi-Position | 3Ø4W

Catalog Number	Positions	Hub	Connectors CU/AL		Bypass	Dimensions			Knockouts			
			Line	Load		D"	W"	H"	1	2	3	4
U2732-XT-HSP	2	(2) C.P.	3/8" -16 Studs	#6-350	Lever	6	32 3/8	25 1/4	4	2 1/2	1/4, 1/2	1/4
U2733-XT-HSP	3	(2) C.P.	3/8" -16 Studs	#6-350	Lever	6	42 3/16	25 1/4	4	2 1/2	1/4, 1/2	1/4
U2734-XT-HSP	4	(2) C.P.	3/8" -16 Studs	#6-350	Lever	6	52 1/4	25 1/4	4	2 1/2	1/4, 1/2	1/4
U2735-XT-HSP	5	(2) C.P.	3/8" -16 Studs	#6-350	Lever	6	62 3/16	25 1/4	4	2 1/2	1/4, 1/2	1/4
U2736-XT-HSP	6	(2) C.P.	3/8" -16 Studs	#6-350	Lever	6	72 3/8	31 1/4	4	2 1/2	1/4, 1/2	1/4

Notes

- **Hubs:** Units are supplied with two closing plates. For proper hub selection, see the hub suffix chart on the accessories page.
- **Bypass:** Lever supplies clamping action on meter spades and also operates bypass device.
- **Connectors:** For line side connector kits, order separately. Order one kit per unit. See accessories page.



Please consult serving utility for their requirements prior to ordering or installing, as specifications and approvals vary by utility, and may require local electrical inspector approval. All installations must be installed by a licensed electrician and must comply with all national and local codes, laws and regulations. Milbank reserves the right to make changes in specifications and features shown without notice or obligation.

Multi-Position Meter Mains

27

125 & 200 AMPS
MULTI-POSITION
METER MAINS

125 & 200 Amps | 4 Terminal | Ringless | 120/240 VAC

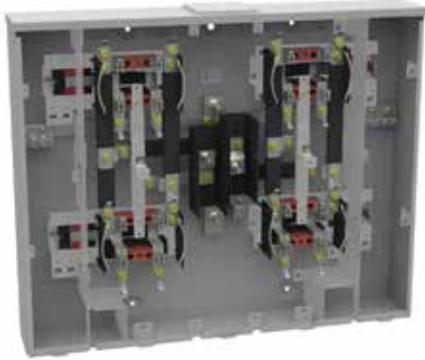

U2854-X-HSP



U2866-X-HSP

125 Amps Per Position | 4 Terminal | Multi-Position Sockets | Ringless

Catalog Number	amp	Positions	Service	Hub	Main Bus Rating Amps	Connector Size		Dimensions		
						Line	Load	D"	W"	H"
U2852-X-HSP	125	2	OH/UG	CP	200	3/8" x 16 Stud	CB	5 ¹³ / ₁₆	18	25
U2853-X-HSP	125	3	OH/UG	CP	200	3/8" x 16 Stud	CB	5 ¹³ / ₁₆	18	37
U2854-X-HSP	125	4	OH/UG	CP	400	3/8" x 16 Stud	CB	4 ⁷ / ₈	31	25
U2855-X-HSP	125	5	OH/UG	CP	400	3/8" x 16 Stud	CB	4 ⁷ / ₈	31	37
U2856-X-HSP	125	6	OH/UG	CP	400	3/8" x 16 Stud	CB	4 ⁷ / ₈	31	37

200 Amps per Position | 4 Terminal | Multi-Position Sockets | Ringless

Catalog Number	amp	Positions	Service	Hub	Main Bus Rating Amps	Connector Size		Dimensions		
						Line	Load	D"	W"	H"
U2862-X-HSP	200	2	OH/UG	CP	250	3/8" x 16 Stud	CB	5 ¹ / ₈	26 ¹ / ₂	30
U2863-X-HSP	200	3	OH/UG	CP	300	3/8" x 16 Stud	CB	5 ¹ / ₈	34 ⁵ / ₈	30
U2864-X-HSP	200	4	OH/UG	CP	400	3/8" x 16 Stud	CB	5 ¹ / ₈	42 ⁵ / ₈	30
U2865-X-HSP	200	5	OH/UG	CP	600	3/8" x 16 Stud	CB	5 ¹ / ₈	51 ¹ / ₂₀	30
U2866-X-HSP	200	6	OH/UG	CP	600	3/8" x 16 Stud	CB	5 ¹ / ₈	59 ³ / ₁₀	30

Connector Kits

Size	Suffix	Kit Number	Compatible With	Wire Range
Single	-K1	K1539	U2852-56, U2862-66	#6-350
	-K3	K1540	U2854-56, U2864-66	#4-600
Twin	-K2	K1350	U2854-56, U2863-66	#6-350
	-K4	K1541	U2864-66	#2-600

Breaker Chart

Manufacturer	150-200 Amps	125 or less
Cutler Hammer	BR, WBJ	QP, BR
Siemens	QNR	QP
G.E.	THQ	THQ
Square D.	-	Homeline

Notes

- **Fifth Terminal:** For field mounted fifth terminal, order catalog number **K2381**. Order one per meter position.
- **Breakers:** Units have provision for one double pole main per meter position. Breakers not included. See breaker chart.
- **Knockouts:** See next page for drawings and knockout configurations.

Please consult serving utility for their requirements prior to ordering or installing, as specifications and approvals vary by utility, and may require local electrical inspector approval. All installations must be installed by a licensed electrician and must comply with all national and local codes, laws and regulations. Milbank reserves the right to make changes in specifications and features shown without notice or obligation.



Temporary Power Outlet

125 Amps | 4 Terminal | Ringless

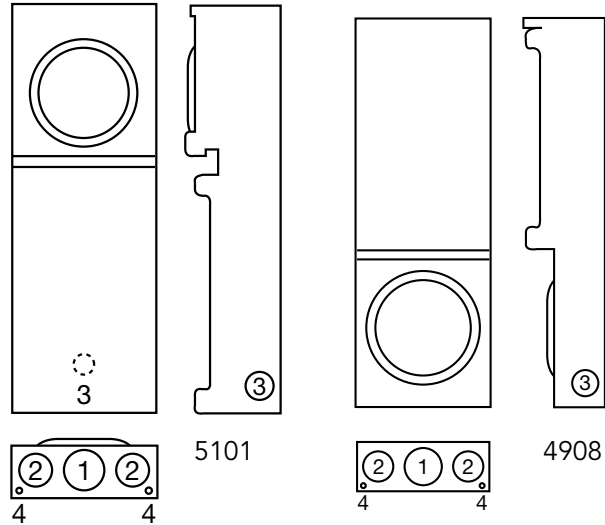

U5101-XL-11GR-HSP

125 Amps | 4 Terminal | Metered Temporary Power Outlet | Ringless

Catalog Number	amp	Service	Hub	Connector Size	Dimensions			Knockouts			
					D"	W"	H"	1	2	3	4
U5101-XL-11GR-HSP	125	OH	CP	#6-250 kcmil	5 $\frac{3}{16}$	8 $\frac{7}{8}$	25	2	1 $\frac{1}{4}$	1 $\frac{1}{4}$	$\frac{1}{4}$
U4908-O-11GR-HSP	125	UG	Blank	#6-2/0	5 $\frac{3}{16}$	8 $\frac{7}{8}$	25	1 $\frac{1}{2}$	1 $\frac{1}{2}$	1 $\frac{1}{4}$	$\frac{1}{4}$

Notes Placeholder TEXT

- **Fifth Terminal:** For field mounted fifth terminal, order catalog number **K5T**. Order one per meter position.



Please consult serving utility for their requirements prior to ordering or installing, as specifications and approvals vary by utility, and may require local electrical inspector approval. All installations must be installed by a licensed electrician and must comply with all national and local codes, laws and regulations. Milbank reserves the right to make changes in specifications and features shown without notice or obligation.

Meter Main with Load Center Pedestal

100–200 Amps | 4 Terminal | Ringless | 120/240 VAC

29
100-200 AMPS
METER MAIN
W/ LOAD CENTER
PEDESTAL

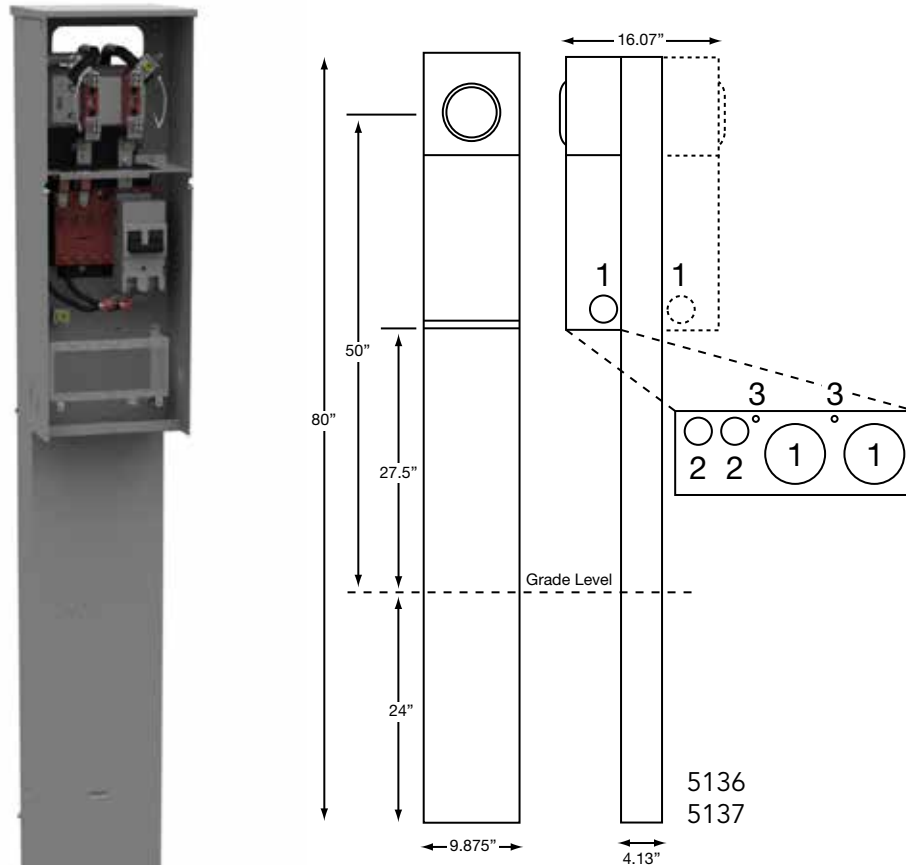

U5136-O-200S-FMG

Specifications

- UL listed File **E90945**
- **K5415** stabilizer foot included with pedestal for field installation
- 200 Amps maximum, 120/240 V, 1Ø3W
- Ringless type meter socket with stainless steel latch
- Pedestals with factory installed breakers are 22KAIC
- Type 3R construction for durable outdoor use
- ANSI 61 grey polyester powder coat finish
- Wire terminations accept copper or aluminum conductors
- Line & Neutral: (2) #6-350 kcmil per phase, Line Ground: (4) #14-1/0
- Load (CB): 2/0 to 300 kcmil per pole for 200 Amps breaker.
- Load neutral: (1) #6-350 kcmil
- Load ground: (2) #14-1/0, (4) #14 – 6
- Commercial grade, plug-in main circuit breaker. Available in 100, 125, 150 & 200 Amps. Type **UQFPH-M**.
- 4 circuit plated copper interior accepts (2) 2-pole or (4) 1-pole standard plug-in type circuit breakers. Four branch circuits rated 125 Amps max. Acceptable manufacturers: Cutler-Hammer, GE, Siemens or Square D Homeline

Please consult serving utility for their requirements prior to ordering or installing, as specifications and approvals vary by utility, and may require local electrical inspector approval. All installations must be installed by a licensed electrician and must comply with all national and local codes, laws and regulations. Milbank reserves the right to make changes in specifications and features shown without notice or obligation.

MEG
APPROVED



MILBANK
ENERGY AT WORK

Meter Main with Load Center Pedestal

100–200 Amps | 4 Terminal | Ringless | 120/240 VAC

100–200 Amps | Meter Main with Load Center Pedestal | Ringless

Catalog Number	Powerheads	Amps	Main Breaker	Interior	Dimensions			Knockouts		
					D"	W"	H"	1	2	3
U5136-O-100S-FMG	Single	100	UQFP-M-100 (Series)	4 circuit	10¼	10	80	2	½,¾	¼
U5136-O-125S-FMG	Single	125	UQFP-M-125 (Series)	4 circuit	10¼	10	80	2	½,¾	¼
U5136-O-150S-FMG	Single	150	UQFP-M-150 (Series)	4 circuit	10¼	10	80	2	½,¾	¼
U5136-O-200S-FMG	Single	200	UQFP-M-200 (Series)	4 circuit	10¼	10	80	2	½,¾	¼
U5136-O-100P-FMG	Single	100	UQFP-M-100 (Parallel)	4 circuit	10¼	10	80	2	½,¾	¼
U5136-O-125P-FMG	Single	125	UQFP-M-100 (Parallel)	4 circuit	10¼	10	80	2	½,¾	¼
U5136-O-150P-FMG	Single	150	UQFP-M-100 (Parallel)	4 circuit	10¼	10	80	2	½,¾	¼
U5136-O-200P-FMG	Single	200	UQFP-M-100 (Parallel)	4 circuit	10¼	10	80	2	½,¾	¼
U5136-O-FMG	Single	—	Breaker provision	4 circuit	10¼	10	80	2	½,¾	¼
U5137-O-100S-FMG	Double	100	(2) UQFP-M-100 (Series)	4 circuit	16¼	10	80	2	½,¾	¼
U5137-O-125S-FMG	Double	125	(2) UQFP-M-125 (Series)	4 circuit	16¼	10	80	2	½,¾	¼
U5137-O-150S-FMG	Double	150	(2) UQFP-M-150 (Series)	4 circuit	16¼	10	80	2	½,¾	¼
U5137-O-200S-FMG	Double	200	(2) UQFP-M-200 (Series)	4 circuit	16¼	10	80	2	½,¾	¼
U5137-O-100P-FMG	Double	100	(2) UQFP-M-100 (Parallel)	4 circuit	16¼	10	80	2	½,¾	¼
U5137-O-125P-FMG	Double	125	(2) UQFP-M-100 (Parallel)	4 circuit	16¼	10	80	2	½,¾	¼
U5137-O-150P-FMG	Double	150	(2) UQFP-M-100 (Parallel)	4 circuit	16¼	10	80	2	½,¾	¼
U5137-O-200P-FMG	Double	200	(2) UQFP-M-100 (Parallel)	4 circuit	16¼	10	80	2	½,¾	¼
U5137-O-FMG	Double	—	Breaker provision	4 circuit	16¼	10	80	2	½,¾	¼

Notes

- **Parallel to Series Conversion:** For field converting from parallel wired to series wired order **K5194**.
- **Fifth Terminal:** For field installed fifth terminal, order **K5T**.
- **Penta Bolt Locking:** For field installed pedestal fronts penta bolt locking, order **K5039**.
- **Receptacles:** Consult factory for installed receptacle assemblies.
- **Pad Mount Units:** Pad mount pedestals are available. Order **U5138** (single meter) or **U5139** (double meter) prefix. **K5035** pad mount kit required. Order separately.



Please consult serving utility for their requirements prior to ordering or installing, as specifications and approvals vary by utility, and may require local electrical inspector approval. All installations must be installed by a licensed electrician and must comply with all national and local codes, laws and regulations. Milbank reserves the right to make changes in specifications and features shown without notice or obligation.

Meter Main with Load Center Pedestal

3 1

100 & 200 Amps | 4 Terminal | Ringless | 120/240 VAC

100 & 200 AMPS
METER MAIN W/
LOAD CENTER
PEDESTAL

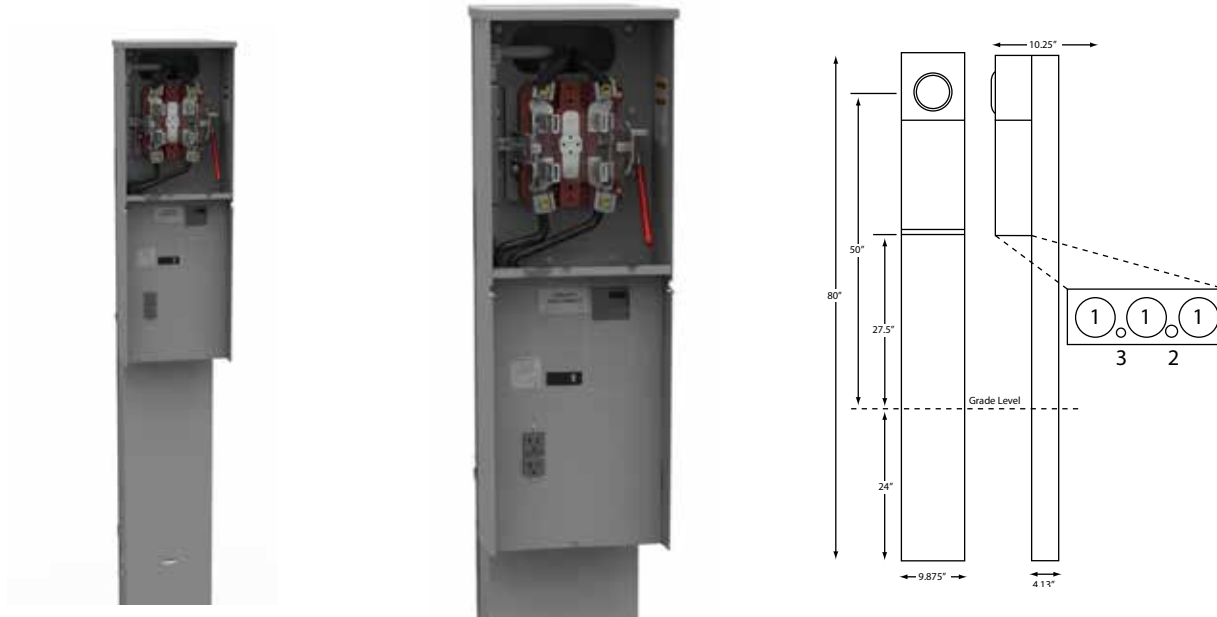

U6396-O-200-10GR-HSP

100 & 200 Amps | Meter Main with Load Center Pedestal | Ringless

Catalog Number	Amp	Service	Connectors CU/AL		Interior	Dimensions			Knockouts		
			Line	Load		D"	W"	H"	1	2	3
U6396-O-100-10GR-HSP	100	UG	(2) #6-350 kcmil	(1) #6-350 kcmil	8 circuit	10¼	10	80	2	½	¼
U6396-O-200-10GR-HSP	200	UG	(2) #6-350 kcmil	(1) #6-350 kcmil	8 circuit	10¼	10	80	2	½	¼

Specifications & Features

- UL listed
- 200 Amps maximum, 120/240 volt, single phase, three wire meter socket
- Short circuit withstand rating of 22K AIC
- Type 3R construction for durable outdoor use, one piece post — lockable and sealable
- Direct bury pedestal
- Circuit breaker: available with 100 or 200 Amps main breaker
- 8-circuit load center with feed through lugs
- Acceptable branch breaker manufacturers: Cutler-Hammer, GE, Siemens, or Square D Homeline
- Milbank grey polyester powder coat finish
- Wire terminations accept copper or aluminum conductors
- Line & neutral: (2) #6-350 kcmil per phase
- Line ground: (4) #14-1/0
- Load neutral: (1) #6-350 kcmil
- Load ground: (2) #14-1/0, (4) #14/6
- 20 Amps GFCI receptacle and 20 Amps breaker factory installed. 2 receptacles factory installed option available
- Stainless steel hasps
- Receptacles: Consult factory for installation of (2) 20 Amps GFCI receptacle assemblies.
- Field installed 5th terminal kits

Please consult serving utility for their requirements prior to ordering or installing, as specifications and approvals vary by utility, and may require local electrical inspector approval. All installations must be installed by a licensed electrician and must comply with all national and local codes, laws and regulations. Milbank reserves the right to make changes in specifications and features shown without notice or obligation.



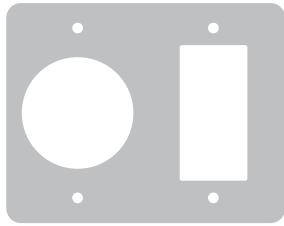
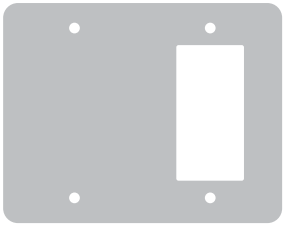
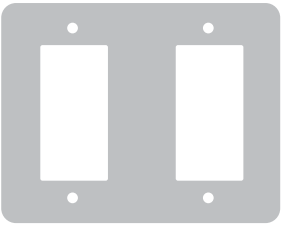

Replacement Parts & Accessories

For U5136–U5139 Pedestals

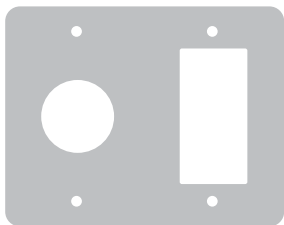
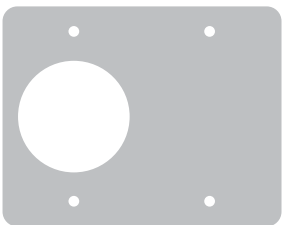
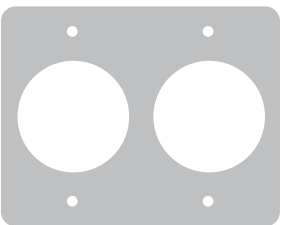
		
K5935-41	K5935-10GR	K5935-11GR

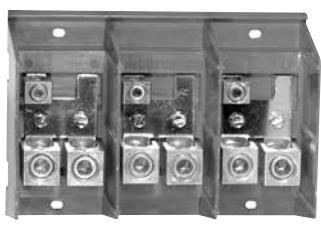
		
K5935-36GR	K5935-54	K5935-2/1450

		
Z1115081 Lug landing base	Z819294-SC With receptacle openings Z1139163 Without receptacle openings	Z1102270 Hinged cover





Please consult serving utility for their requirements prior to ordering or installing, as specifications and approvals vary by utility, and may require local electrical inspector approval. All installations must be installed by a licensed electrician and must comply with all national and local codes, laws and regulations. Milbank reserves the right to make changes in specifications and features shown without notice or obligation.



Replacement Parts & Accessories

For U5136–U5139 Pedestals

33

REPLACEMENT
PARTS &
ACCESSORIES

		
Q120 20 Amps, 1 pole circuit breaker	Q130 30 Amps, 1 pole circuit breaker	Q250 50 Amps, 2 pole circuit breaker

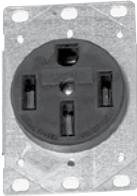
		
Z708080-MO 20 Amps GFI receptacle NEMA 5-20GR	Z701776-MO 30 Amps receptacle NEMA TT-30	Z708767-MO 50 Amps receptacle NEMA 14-50R

Please consult serving utility for their requirements prior to ordering or installing, as specifications and approvals vary by utility, and may require local electrical inspector approval. All installations must be installed by a licensed electrician and must comply with all national and local codes, laws and regulations. Milbank reserves the right to make changes in specifications and features shown without notice or obligation.



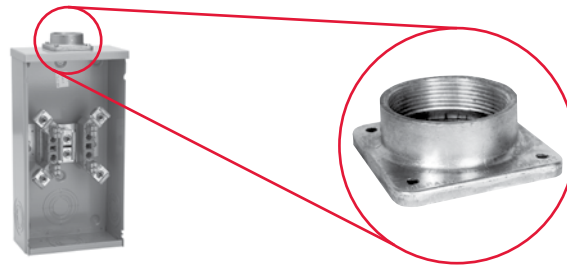
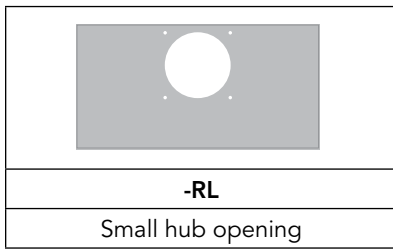

-WL A7514	-YL A7515	-ZL A7516	-DL A7517	-EL A7518	-XL A7551
1" hub	1¼" hub	1½" hub	2" hub	2½" hub	Small closing plate

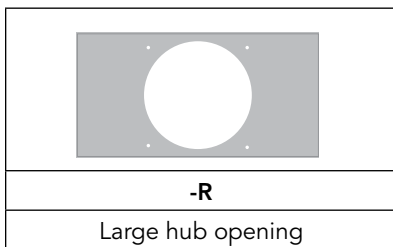

-F A8110	-G A8111	-H A8112	-X A9064	-RRL S8324
3" hub	3½" hub	4" hub	Large closing plate	Large hub opening adapted to small hub opening

Notes

- **Suffix:** Add to catalog number for factory installation of hub.
- **Packaging:** Individually packed units for field installation.
- **Abbreviations:** H.O. (hub opening), C.P. (closing plate).



Please consult serving utility for their requirements prior to ordering or installing, as specifications and approvals vary by utility, and may require local electrical inspector approval. All installations must be installed by a licensed electrician and must comply with all national and local codes, laws and regulations. Milbank reserves the right to make changes in specifications and features shown without notice or obligation.

Accessories

Connector Kits, Closing Kits & Generator Interlock

Connector Kits — For Use with 3/8"-16 Stud Type Units Only

Single			Twin		
Suffix	Part #	(3 per set) - 1Ø	Suffix	Part #	(3 per set) - 1Ø
K1	K1539	6-350	K2	K1350	6-350
K3	K1540	4-600 or (2) 1/0-250*	K2L	K1350L	6-350 (non rotating)
K3L	K1540L	4-600 or (2) 1/0-250* (non rotating)	K4	K1541	4-600
Suffix	Part #	(4 per set) - 3Ø	Suffix	Part #	(4 per set) - 3Ø
K5	K3082	6-350	K6	K3442	6-350
K7	K3441	4-600 or (2) 1/0-250*	K8	K3083	4-600

*For (2) 1/0-250, conductors must be of same size.

Bypass Link



K8180 (sold in pairs)

Note

Consult factory for proper connector kits for studded meter sockets.

Closing Covers

Meter Closing Plate (Ring Type / Ringless)	Metal Closing Plate (For Ringless Sockets)
6003 - Grey Plastic	CP-21
6116 - Clear Plastic	

Generator Interlock

K5815 - large QN with small frame Q
K5820 - large frame QN with large frame QN
K5830 - small frame Q to small frame Q

Disconnect Sleeve

M5-144
Do not use with lever bypass sockets

Anti-Inversion Clip

K4802



Isolated Neutral Kit

K1047
Consult factory for proper isolated neutral for meter sockets

Please consult serving utility for their requirements prior to ordering or installing, as specifications and approvals vary by utility, and may require local electrical inspector approval. All installations must be installed by a licensed electrician and must comply with all national and local codes, laws and regulations. Milbank reserves the right to make changes in specifications and features shown without notice or obligation.

Fifth Terminal, Tap Connectors & Block Assemblies

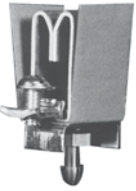
Fifth Terminal

		
5T8K2 - 100-200 Amps "Plug-In"	K5T - 200 Amps (Block with Square Hole)	K3865 - Heavy Duty Jaw Clamping (K3866 without Neutral Wire)

Tap Connectors (3 per set)

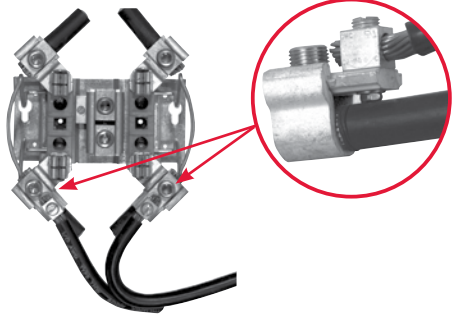
	Replaces the load or line side slide-in nut assembly on Milbank 200 Amps sockets. Allows for a 100 Amps tap location in addition to the #6-350 kcmil load-side connector. K5022 includes safety barrier extensions for applications over 300 VAC. Three lugs per kit.
K4977-INT - Internal Hex	
K4977-EXT - External Hex	
K5022-INT - Internal Hex (set of 4 w/ barrier)	

Triplex Ground

K1190 (For factory installed triplex ground, add suffix -TG to catalog number)

100 Amps Blocks (single sockets only)

BL7474 - Block Assembly
BL7499 - Horn Bypass Block Assembly
Z904486-AO - Slotted Nut Assembly
Z903274-AO - Horn Bypass Nut Assembly
Z802965-AC - Neutral without Nut
Z901925-AC - Hex Nut Set Screw

200 Amps Blocks (single sockets only)

K4527 - Internal Hex Block Assembly (w/ meter support)
K4528 - External Hex Block Assembly (w/ meter support)
K4529 - Internal Hex Horn Bypass Block Assembly (w/ meter support)
K4530 - External Hex Horn Bypass Block Assembly (w/ meter support)
Z916265-AO - Internal Nut Assembly
Z916264-AO - External Nut Assembly
Z814898-AC - Neutral without Nut



Please consult serving utility for their requirements prior to ordering or installing, as specifications and approvals vary by utility, and may require local electrical inspector approval. All installations must be installed by a licensed electrician and must comply with all national and local codes, laws and regulations. Milbank reserves the right to make changes in specifications and features shown without notice or obligation.

Enclosed Controls

Attractive | Easy to Install | Secure | Cost-Effective

Milbank Enclosed Controls are pad-mounted, weather resistant electrical enclosures consisting of a utility pull section with optional meter socket, and a customer section containing distribution and control equipment. Commercial pedestals are an attractive, secure, easy to install and cost-effective solution when underground remote site power distribution and control equipment is required, replacing unsightly and inefficient strut and backboard structures.



Strut and backboard



Commercial pedestal

UL Listed as Industrial Control Equipment (File E113855)

Standard Features

- Type 3R rain-resistant, vandal-resistant cabinet of polyurethane powder coated steel (aluminum or stainless steel also available)
- UL listed as enclosed industrial control equipment (UL508A)
- Isolated lockable and sealable utility metering and lug landing sections
- Lockable customer section for distribution and control equipment with internal deadfront
- Print pocket inside customer section door contains wiring schematics and installation instructions
- Load centers are UL listed for use with various manufacturers' circuit breakers
- All stainless steel external hardware (screws, bolts, hinges, handles, hasps and sealing screws)



Please consult serving utility for their requirements prior to ordering or installing, as specifications and approvals vary by utility, and may require local electrical inspector approval. All installations must be installed by a licensed electrician and must comply with all national and local codes, laws and regulations. Milbank reserves the right to make changes in specifications and features shown without notice or obligation.





Applications

These units are ideal for controlling and metering:

- Traffic signals
- Street lighting
- Power distribution for electronic vehicle charging stations
- Communication equipment such as cell towers and telephone vaults
- Event power for fairgrounds, swap meets, outdoor markets, portable offices, holiday lights, etc.
- Outdoor lighting for athletic fields, tennis and basketball courts, parking lots, landscaping and subdivision entrances, etc.

Available Factory-Installed Options

- Meter sockets: ring type or ringless, up to 400 Amps
- Main and branch breakers or T fuses
- Distribution: copper load centers and panel boards
- Clocks, timers and relays
- Photoelectric cells and controls
- Various power receptacles: pin and sleeve, twist lock or straight blade
- Contactors: lighting, definite purpose, motor starters
- Surge protection and lightning arrestors
- Generator inlets with interlocked breakers
- Push button controls
- Thermostat controls, fans and heating strips
- Power blocks and terminal blocks
- Steel, aluminum and plywood backboards
- Transformers
- Interlock devices for circuit breakers

Options

- Available in steel, aluminum (raw painted or anodized) or stainless steel construction with powder coated finish available in eight standard colors or special-ordered RAL colors
- Available for applications up to 400 Amps, 120V, 208V, 240V, 277V, 480V - 1Ø or 3Ø

Accessories

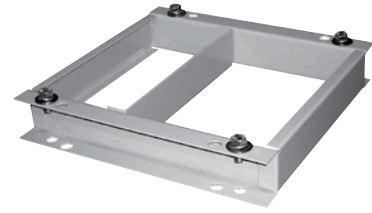

Padmount bases available for all pedestal sizes, inquire with your representative for details

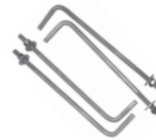

CP-ABK5/8

Anchor bolt kit (includes four 5/8 - 13 x 18" anchor bolts)



105J

Fifth terminal kit for use with ring type meter sockets



K3865

Fifth terminal kit for use with ringless meter sockets



CP-TC7D

7-day time clock kit

CP-TC24H

24-hour time clock kit

CP-TCWIRE

Male 4-pin connector and wiring harness for use with time clocks other than above



CP-PE-HOA-3POS

HOA switch for field installation



Please consult serving utility for their requirements prior to ordering or installing, as specifications and approvals vary by utility, and may require local electrical inspector approval. All installations must be installed by a licensed electrician and must comply with all national and local codes, laws and regulations. Milbank reserves the right to make changes in specifications and features shown without notice or obligation.

Enclosed Controls

Main Load Center Commercial Pedestals

Main Load Center Commercial Pedestal

1Ø3 wire 120/240V or 208Y/120V

Application: remote site service for multiple loads

Milbank Main Load Center Commercial Pedestals are designed to handle the vast majority of all requirements in a standard, stocked configuration.

- All units feature a load center with a plug-on, back-fed main breaker.
- Standard units are equipped with with a 16 circuit load center in the 100 Amp or 24 circuit load center in 200A models
- Sub-feed lugs to allow feeding an external panel.

If your application requires turning loads on based on “dusk-to-dawn” requirements, be sure to see the Milbank Switched Load Center Commercial Pedestal products on the following page.

Features

These units include everything required for remote site service:

- Expandable: load centers allow for future expansion without costly modifications.
- All units feature a 200 Amps meter socket with optional field-installable fifth terminal kit available.
- 22K Amps interrupting capacity (AIC) standard.
- Optional mounting base can be embedded in concrete for fast, easy installation.
- Separate sealable and lockable utility termination section.
- Separate sealable and lockable metering section.
- Separate sealable and lockable customer section with a load center for “always on” loads that include a main circuit breaker, 20 (125 or 200 Amps model) or 14 (100 Amps model) blank breaker spaces and a circuit directory to document configuration.



Please consult serving utility for their requirements prior to ordering or installing, as specifications and approvals vary by utility, and may require local electrical inspector approval. All installations must be installed by a licensed electrician and must comply with all national and local codes, laws and regulations. Milbank reserves the right to make changes in specifications and features shown without notice or obligation.



Switched Load Center Commercial Pedestals

1Ø3 wire 120/240V or 208Y/120V

Designed not only to provide power for various loads, but also to switch specific loads on and off under certain conditions. A photoelectric cell is used for these controlled loads, and an optional time clock is also available.

Features

These units include everything required for remote site service:

- Expandable: load centers allow for future expansion without costly modifications.
- All units feature a 200 Amps meter socket with optional field-installable fifth terminal kit available.
- 22K Amps interrupting capacity (AIC) standard.
- Optional mounting base can be embedded in concrete for fast, easy installation.
- Separate sealable and lockable utility termination section.
- Separate sealable and lockable metering section.
- Separate sealable and lockable customer section with a control circuit including PE receptacle, Lexan® window, glare shield, Hand-Off-Auto (HOA) switch, contractor controlling a 16-circuit load center for controlled loads, a pre-mounted DIN rail and pre-wired connector to add an optional "plug-and-play" time clock kit for PE on and TC off operation and a circuit directory to document configuration.
- A load center for "always on" loads that includes a main circuit breaker, a control power circuit breaker, a switched load center main breaker, nine (125 or 200 Amps model) or 11 (100 Amps model) blank breaker spaces and a circuit directory to document configuration.



Traffic Signals

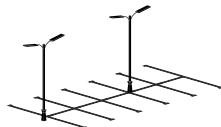

Parking Lots



Highways

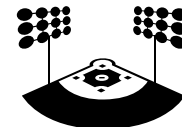

Athletic Field Lighting

Enclosed Controls

400 Amps Commercial Pedestals

41
400 AMPS
COMMERCIAL
PEDESTALS



Designed to provide a weather and vandal resistant metered enclosure for various loads and distribution. Each pedestal has been designed to handle a wide range of applications using standard, stocked configurations.

- Choice of a single main breaker or twin service disconnect breakers gives flexibility to the pedestal design.
- Optional distribution with feed-through lugs below the service disconnect breakers allows the pedestal to handle numerous applications.
- Typical applications include remote homes where the metering is best located at the curb side or other remote area. The pedestal can also provide power to secondary residence, on-site business, workshop, irrigation, lighting, security or other secondary load.
- Available in custom colors to match home or landscaping.

Features

These units include everything required for remote service:

- Main circuit breaker or dual service disconnects
- Expandable: load center units allow for future expansion without costly modifications
- Optional mounting base can be embedded in concrete for fast, easy installation
- Separate sealable and lockable utility termination section with lug termination
- Separate sealable and lockable metering section
- A separate sealable and lockable customer section with a circuit directory and a print pocket to hold all documentation
- Meter socket options include ring type with bypass studs, ringless with heavy duty lever bypass, or K-Type bolt-on

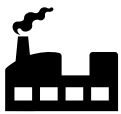

Commercial Job sites



Remote site for
Residential &
Commercial job Sites

Please consult serving utility for their requirements prior to ordering or installing, as specifications and approvals vary by utility, and may require local electrical inspector approval. All installations must be installed by a licensed electrician and must comply with all national and local codes, laws and regulations. Milbank reserves the right to make changes in specifications and features shown without notice or obligation.



Surface-Mount Commercial Pedestal

Originally developed for small cellular communications, the surface-mount enclosed control offers the flexibility of larger enclosed controls products with a smaller footprint and several mounting options.



Features

- Easy installation
- Overhead and underground entry and exit, all in one unit
- Meter and components in one enclosure
- UL508A & UL891
 - Custom component configurations
 - UL listing covers all internal components
- Can be mounted on multiple surfaces
 - Walls
 - Poles – narrow profile will have minimal extension past sides
 - H Frames (Strut)
- Multiple bypass options available
- Monitoring options available
- Can be powder coated in any Milbank standard EC colors or custom colors.



Benefits

- Does not take up sidewalk space
- Flood resistant
- Eliminates need for connecting components - Wire in - Wire Out

Applications



**Communications
Power
Distribution**



**Lighting
Control**

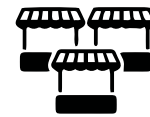

**Streetscape
Power
Distribution**



Please consult serving utility for their requirements prior to ordering or installing, as specifications and approvals vary by utility, and may require local electrical inspector approval. All installations must be installed by a licensed electrician and must comply with all national and local codes, laws and regulations. Milbank reserves the right to make changes in specifications and features shown without notice or obligation.

Enclosed Controls

Battery Backup Commercial Pedestals

43

BATTERY BACKUP
COMMERCIAL
PEDESTALS

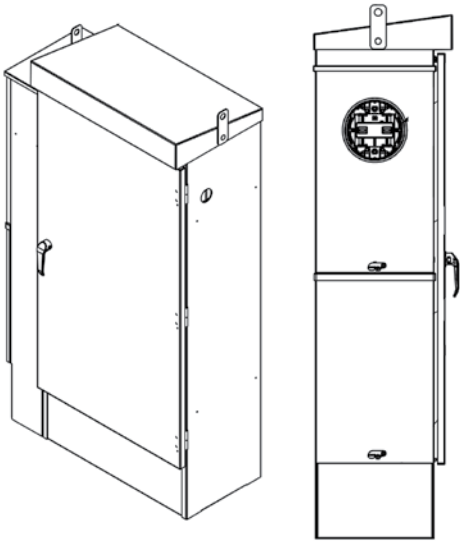

Designed to provide battery backup power for various loads, and to switch specific loads on and off under certain conditions; a photoelectric cell or time clock to control lighting circuits, as an example. Metered and unmetered power distribution options are available. The back-up power pedestal is designed to handle the vast majority of today's back-up power requirements. By using a 19" rack design, shelves can be adjusted to accommodate the required batteries and manufactures DC to AC inverters, transfer switches and other related equipment. This design gives the user a wide range of design and configuration options. Complete turnkey, ready to power-up pedestals are offered along with basic units ready to accept batteries and inverters supplied by others.

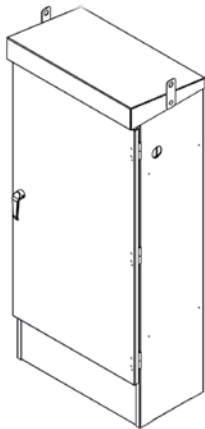

Features

- 100 through 320 Amps meter socket with the option of either a ring type socket (conforms to EUSERC 308) with or without test/bypass blocks or a heavy duty ringless socket with lever bypass
- Separate sealable utility termination compartment
- An isolated separate customer section with service disconnects, power distribution options and power control
- 19" wide rack in customer compartment for easy layout of equipment
- Battery trays
- Thermostat with cooling fan
- Filtered louvers for heat rise flow through ventilation
- Three point door latch (key or pad lockable)

Note

- May require customization based on regional requirements



Traffic Signals



Communications
Power Distribution



Parking Lots



Camera & Security
Locations

Options

- Manual bypass switch
- Transfer switch for generator power back-up
- Generator inlet receptacles 30 Amps through 200 Amps
- Pad lockable provision for receptacles
- Police access door
- Metered load center distribution
- Unmetered load center distribution
- Photo electric controls (for street lighting)
- Time clocks
- HOA switches
- Contactors
- GFCI duplex receptacles
- Thermostat for heating control
- Heating pads or elements
- Roll out shelves for batteries
- Surge arrestors and lighting arrestors

Please consult serving utility for their requirements prior to ordering or installing, as specifications and approvals vary by utility, and may require local electrical inspector approval. All installations must be installed by a licensed electrician and must comply with all national and local codes, laws and regulations. Milbank reserves the right to make changes in specifications and features shown without notice or obligation.



Enclosed Controls

Power Transfer Commercial Pedestals



Providing metered or unmetered AC power, distribution, surge suppression, mechanical interlock and stand-by generator receptacle — all in a neat, compact pedestal.

Features

- 120/240V 1Ø3W through 277/480V 3Ø4W ratings
- Metered or unmetered units
- Choice of EUSERC ring type or ringless meter sockets
- 60 Amps through 400 Amps ratings
- Pad lockable, isolated utility compartments
- 20 Amps GFCI convenience receptacle
- Lockable recessed generator receptacle door
- Utility and generator indicator light options
- All stainless steel hardware
- Galvanized steel, aluminum or stainless steel cabinet options
- Custom designs available

Note

- May require customization based on regional requirements



Traffic Signals



Pump & Lift
Stations



Communications
Power Distribution



Please consult serving utility for their requirements prior to ordering or installing, as specifications and approvals vary by utility, and may require local electrical inspector approval. All installations must be installed by a licensed electrician and must comply with all national and local codes, laws and regulations. Milbank reserves the right to make changes in specifications and features shown without notice or obligation.

Enclosed Controls

CT Metered Commercial Pedestals

45
CT METERED
COMMERCIAL
PEDESTALS



Designed to be used where a smaller service package would be a better choice over larger switchgear equipment, these pedestals have amperage ratings of 400 to 800 Amps at voltages up through 480 volt three phase.

Features

- Up to 800 Amps
- A low profile CT pedestal
- All utility equipment is isolated in separated pad lockable and sealable compartments
- Separate customer compartment designed to hold distribution and control equipment
- Dead front customer construction
- Optional mounting base
- Optional construction in steel, aluminum and stainless steel
- Wide choice of powder paint colors

Note

- May require customization based on regional requirements

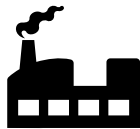

Commercial &
Industrial Control
Systems



Pump & Lift
Stations



Water Treatment
Plants



Electric Vehicle
Charging Stations

Please consult serving utility for their requirements prior to ordering or installing, as specifications and approvals vary by utility, and may require local electrical inspector approval. All installations must be installed by a licensed electrician and must comply with all national and local codes, laws and regulations. Milbank reserves the right to make changes in specifications and features shown without notice or obligation.



Enclosed Controls

Slimline Commercial Pedestals



Provides a sleeker, smaller footprint, with wireway access on the side of the unit rather than the back, allowing maximum flexibility to place the pedestal anywhere physical space is at premium.

Providing unmetered AC power, distribution, surge suppression, mechanical interlock and stand-by generator receptacle — all in a neat, compact pedestal.

Features

- 100 or 200 Amps
- Vandal-resistant, secure and attractive design
- Customer compartment with distribution and control equipment with swing dead front door, secured with both a hasp/latch and draw latch outer door
- Utility metering compartment protected with a hinged hood, increasing resistance to meter vandalism
- Small footprint
- Wireway located on left side of pedestal for utility incoming wire, allowing pedestal to be mounted with back as close as 14" to walls or structures
- Available in 12" and 20" widths and 50" and 63" (metered) and 43" (unmetered) heights
- Includes a print pocket for plans and drawings
- Voltage range: 120V–480V
- Compatible with both ringless and ring type meter sockets, 4–7 terminals
- Available in a wide array of colors, including but not limited to all ANSI powder coated paint colors upon request
- Pedestal mounting base option saves time and labor to install on a cement pad—no anchor bolts required
- Powder coated G90 galvanized steel or Aluminum; raw, anodized or powder coated, as well as stainless steel exterior options

Note

- May require customization based on regional requirements



Water Treatment
Plants



Highways



Parks &
Landscaping



Direct bury pedestals offer many advantages. With no need to coordinate, buy or wait for concrete, installation time can be cut down to less than an hour. Traditional direct bury pedestals are awkward to transport and handle and can only be used in a direct bury application. Milbank's modular design offers flexibility and convenience for distributors and contractors alike.



It's constructed with 14 gauge steel and only available for 12" pedestals.



Please consult serving utility for their requirements prior to ordering or installing, as specifications and approvals vary by utility, and may require local electrical inspector approval. All installations must be installed by a licensed electrician and must comply with all national and local codes, laws and regulations. Milbank reserves the right to make changes in specifications and features shown without notice or obligation.

Watt-hour Meter Forms

Standard Forms | Transformer Rated or Self-Contained

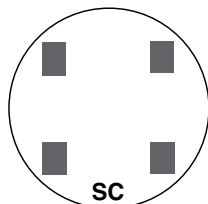

SC
2 and 3-WIRE FORMS
1S & 2S

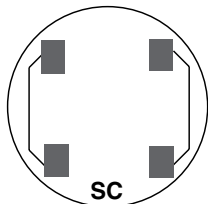

SC
2 and 3-WIRE FORMS
1S & 2S with BYPASS

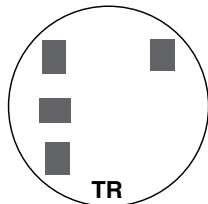

TR
2-WIRE FORM 3S
5th Term. 9 o'clock

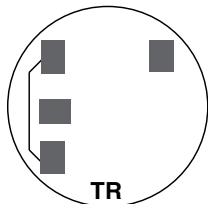

TR
2-WIRE FORM 3S
with BYPASS

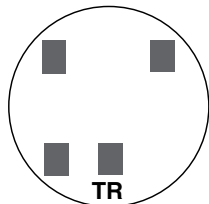

TR
2-WIRE FORM 3S
5th Term. 6 o'clock

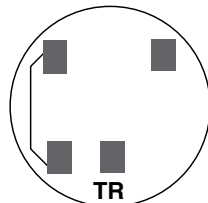

TR
2-WIRE FORM 3S
with BYPASS

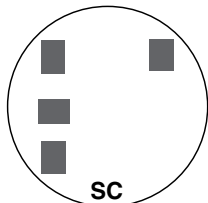

SC
2 ELEMENT
3-WIRE NETWORK
FORM 12S 5th
TERM. 9 o'clock

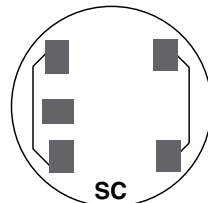

SC
2 ELEMENT 3-WIRE
NETWORK FORM 12S
with BYPASS
5th Term. 9 o'clock

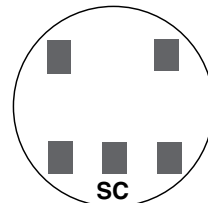

SC
2 ELEMENT
3-WIRE NETWORK
FORM 12S 5th
TERM. 6 o'clock

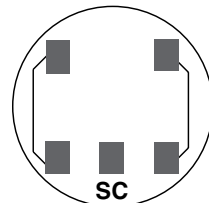

SC
2 ELEMENT 3-WIRE
NETWORK FORM 12S
with BYPASS
5th Term. 6 o'clock

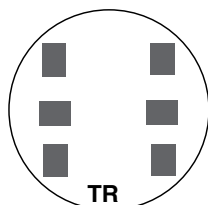

TR
3-WIRE FORM 4S

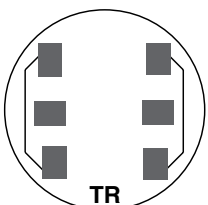

TR
3-WIRE FORM 4S
WITH BYPASS

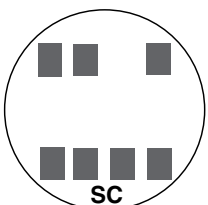

SC
2 or 3 ELEMENT
3Ø4W Y or
Y FORM 14S
FORM 15S
Y FORM 16S

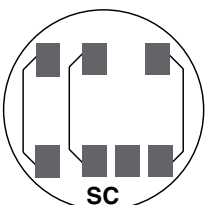

SC
2 or 3 ELEMENT
3Ø4W Y or
FORMS 14S & 15S
with BYPASS

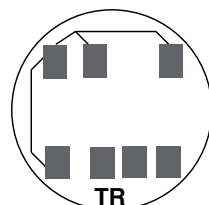

TR
2 ELEMENT
3Ø4W Y or
Y FORM 7S
FORM 24S
with BYPASS

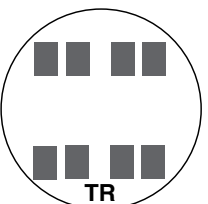

TR
2 ELEMENT
2Ø3W, 2Ø4W, 3Ø3W
FORM 5S

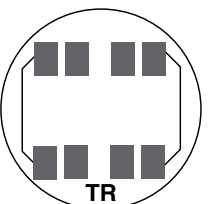

TR
2 ELEMENT Ø3W,
2Ø4W, 3Ø3W
FORM 5S with
BYPASS

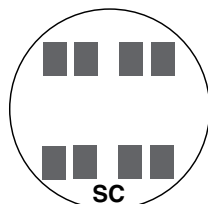

SC
2 ELEMENT
2Ø3W, 2Ø4W, 3Ø3W
FORM 13S

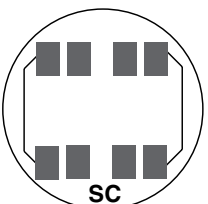

SC
2 or 3 ELEMENT
2Ø3W, 2Ø4W, 3Ø3W
FORM 13S with
BYPASS

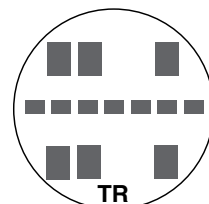

TR
2 or 3 ELEMENT
3Ø4W Y or
Y FORM 9S
FORM 8S

TR = TRANSFORMER RATED
SC = SELF CONTAINED

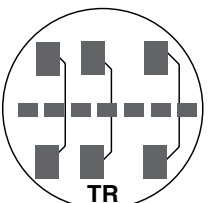

TR
2 or 3 ELEMENT
3Ø4W Y or
FORMS 8S & 9S
FORMS 8S & 9S
with BYPASS

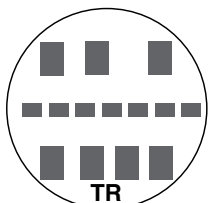

TR
2 ELEMENT
3Ø4W Y
FORM 6S

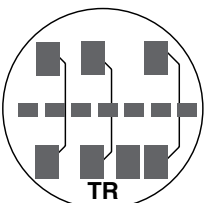

TR
2 ELEMENT
3Ø4W Y
FORM 6S
with BYPASS

Please consult serving utility for their requirements prior to ordering or installing, as specifications and approvals vary by utility, and may require local electrical inspector approval. All installations must be installed by a licensed electrician and must comply with all national and local codes, laws and regulations. Milbank reserves the right to make changes in specifications and features shown without notice or obligation.



DIAGRAM A
1 \emptyset 2W with 1 P.T. & 1 C.T.
Single Stator Meter (2W1 \emptyset) - Form 3S
5T Socket, Test Switch #TS04-0101

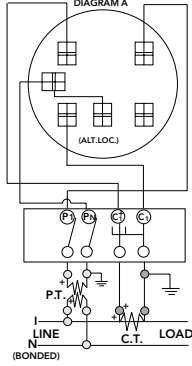

DIAGRAM B
1 \emptyset 3W with 1 C.T.
Single Stator Meter (2W1 \emptyset) - Form 3S
5T Socket, Test Switch #TS04-0101

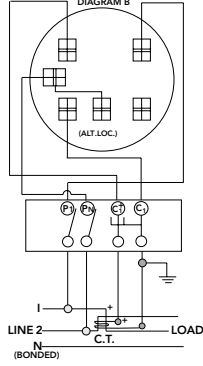

DIAGRAM C
1 \emptyset 3W with 2 C.T.'s
Single Stator Meter (3W1 \emptyset) - Form 4S
6T Socket, Test Switch #TS07-0105

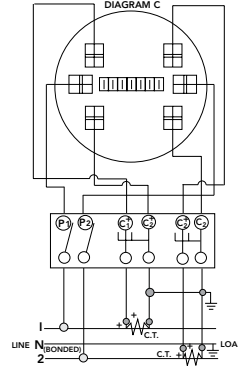

DIAGRAM D
1 \emptyset 3W or 3W Network with 2 C.T.'s
2 Stator Meter - Form 5S
8T Socket, Test Switch #TS07-0105

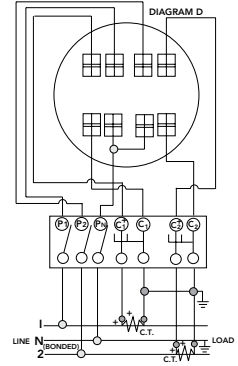

DIAGRAM E
3 \emptyset 3W "A" with 2 P.T.'s & 2 C.T.'s
2 Stator Meter - Form 5S
8T Socket, Test Switch #TS07-0105

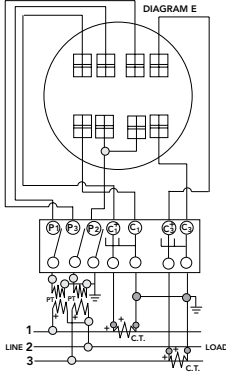

DIAGRAM F
3 \emptyset 3W "A" with 2 C.T.'s
2 Stator Meter - Form 5S
8T Socket, Test Switch #TS07-0105

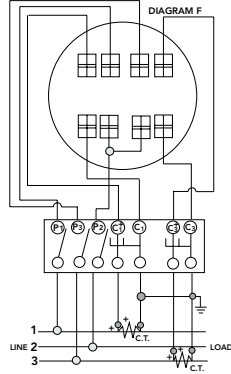

DIAGRAM G
3 \emptyset 4W "Y" with 3 C.T.'s
2 1/2 Stator Meter - Form 6S
13T Socket, Test Switch #TS10-0109

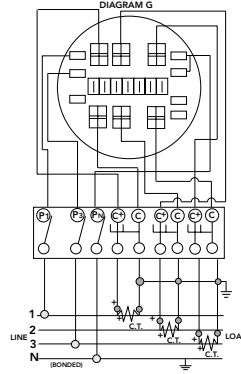

DIAGRAM H
3 \emptyset 4W "Y" with 2 P.T.'s & 3 C.T.'s
2 1/2 Stator Meter - Form 6S
13T Socket, Test Switch #TS10-0109

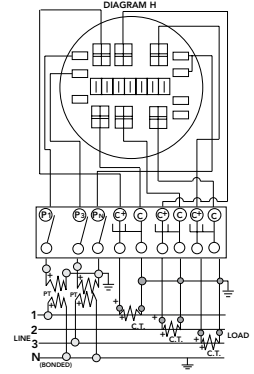

DIAGRAM I
3 \emptyset 4W "Y" or "A" with 3 C.T.'s
"Y" 3 Stator Meter - Form 9S
"A" 2 Stator Meter - Form 8S
13T Socket, Test Switch #TS10-0109

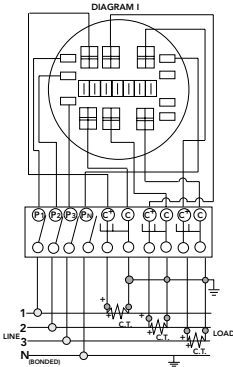
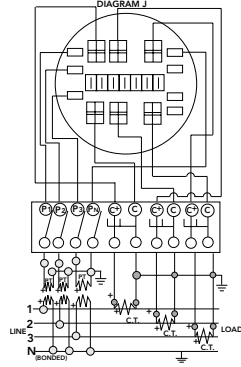

DIAGRAM J
3 \emptyset 4W "Y" with 3 P.T.'s & 3 C.T.'s
3 Stator Meter - Form 9S
13T Socket, Test Switch #TS10-0109



Prewiring: If standard factory prewiring is required, refer to wiring diagrams on this page. Determine appropriate diagram and send a copy with order. If custom factory prewiring is required, specify on order. Be sure to include meter socket catalog number, test switch make and catalog number, meter form number and provide a copy of your wiring diagram.



Please consult serving utility for their requirements prior to ordering or installing, as specifications and approvals vary by utility, and may require local electrical inspector approval. All installations must be installed by a licensed electrician and must comply with all national and local codes, laws and regulations. Milbank reserves the right to make changes in specifications and features shown without notice or obligation.

Energization of Electrical Equipment

Important Information for Installers

Important Note

In addition to national and local electrical codes, many utilities have specific requirements for metering equipment. Always consult the serving utility for their specifications and requirements prior to ordering or installing Milbank meter mounting equipment.

Before Energizing

- A. Give equipment a thorough visual examination to determine that:
 - 1) No shipping or installation damage exists.
 - 2) Proper clearances have been maintained.
 - 3) All connections have been made.
 - 4) Equipment is clean and dry.
- B. Make a thorough examination to:
 - 1) Verify tightness of all bolted connections (see table below).
 - 2) Manually operate all circuit breakers, switches, relays, etc.
 - 3) Check rigidity of all mountings, bus bars and components.
 - 4) Use test equipment to check continuity of circuitry and integrity of insulation.
- C. All switches and circuit breakers should be in the "off" position.
- D. Verify that manual meter bypass (if applicable) is in non-bypass position.
- E. Install cover and/or close doors.
- F. If installation is not being energized at this time, follow "after-energizing" steps listed below. These steps will secure the installation in case of accidental energization.

When Energizing

- A. Use caution and follow established safety procedures:
 - 1) Wear safety apparel.
 - 2) Use safety equipment.
 - 3) Take action to prevent injury to yourself and others in the event of failure of the installation.
 - 4) Take action to prevent/decrease damage to property in the event of failure of the installation.
 - 5) If you are unsure how to safely energize the installation, get someone who is knowledgeable to do it.

After Energizing

- A. Secure the installation:
 - 1) To prevent accidental contact with energized parts, cover all openings with approved filler devices.
 - 2) To prevent unauthorized access, secure all covers and/or doors with approved security devices.
 - 3) Attach/post information to advise others of potential hazards associated with the installation.

Recommended Torque for General Applications*

Nominal Size	Joint Description		Head Type	Torque (Inch Lbs.)
	Screw	Nut		
10	Brass	Brass Nut or Extruded Hole	All	20-25 inch lbs.
10	Steel	Copper or Aluminum Busbar $\leq 1/8"$	All	25-30 inch lbs.
10	Steel	Steel Nut or Extruded Hole; CU or AL Busbar $> 1/8"$	All	30-35 inch lbs.
12	Steel	Aluminum Extruded Hole	All	30-35 inch lbs.
12	Steel	Steel Nut or Extruded Hole	All	40-50 inch lbs.
1/4	Steel	Aluminum Extruded Hole	All	40-50 inch lbs.
1/4	Steel	Steel Nut or Extruded Hole; CU or AL Busbar	All	50-60 inch lbs.
5/16	Steel	Aluminum Extruded Hole	Hex	60-70 inch lbs.
5/16	Steel	Steel Nut or Extruded Hole; CU or AL Busbar	Hex	100-150 inch lbs.
3/8	Steel	Steel Nut	Hex	150-200 inch lbs.
1/2	Steel	Steel Nut	Hex	200-250 inch lbs.

* Interior labels typically indicate the required torque for wire connectors and studs, and should be referenced first.
CU: Copper
AL: Aluminum

Please consult serving utility for their requirements prior to ordering or installing, as specifications and approvals vary by utility, and may require local electrical inspector approval. All installations must be installed by a licensed electrician and must comply with all national and local codes, laws and regulations. Milbank reserves the right to make changes in specifications and features shown without notice or obligation.



Materials

Steel Quality

The meter equipment listed in this catalog is made of galvanized steel (AISI* G90) to afford the best possible weather proofing.
*American Iron and Steel Institute.

Steel Sheet

16 gauge, galvanized, sheet: 1 1/4 oz./ sq.ft. class zinc-coated. (AISI G90)
14 gauge, galvanized, sheet: 1 1/4 oz./ sq.ft. class zinc-coated.

Aluminum Extrusion

Wire-Terminal: Alloy; 6061-T6, Tin-plated for CU/AL wire.
Bus Bar: Alloy; 6101-O & 6063-O

Aluminum Sheet

3000 series aluminum sheet, H14, or 5052 series aluminum sheet, H32. Where applicable thicknesses range from .064-.125

Copper Sheet & Bus

Electrolytic copper with tin plating in most applications.

Insulating Materials

- In most units, support bases for current-carrying components are molded from fiberglass reinforced high-strength, track resistant, thermoset polyester molding compounds.
- Clear or black safety shields and polarity barriers are molded from high-strength, track resistant, polycarbonate molding compounds.
- Various sheet insulating materials, as appropriate for the application are utilized in the fabrication of flat, formed and punched component parts and barriers.

Finish

Process

Light gray state-of-the-art electrostatically applied powder paint offers a durable, non-fading finish. For further information concerning the chemical analysis of the weather resistant finish, please contact the factory.

Metal Fasteners

Zinc-coated with a chromate dip.

Ratings & Compliance

Ratings & Compliance

All Milbank electrical enclosures in this catalog are rated "Type 3R Enclosure" unless specified otherwise on the product's page. All enclosures with a UL designation are constructed per the appropriate UL Standard and may be installed per the National Electric Code. UL procedure files associated with the UL Standards are listed as follows: Meter Sockets (UL 414, File E30202), Test Switches (UL 414, File E62531), Power Outlets (UL 231, File E90945), Panelboards (UL 67, File E32628) and Pullout Switches (UL 1429, File E133062). Additional standards are utilized as applicable: Meter Sockets (ANSI C12.7), Test Switches (ANSI C12.9) and Panelboards (NEMA PB-1).



Please consult serving utility for their requirements prior to ordering or installing, as specifications and approvals vary by utility, and may require local electrical inspector approval. All installations must be installed by a licensed electrician and must comply with all national and local codes, laws and regulations. Milbank reserves the right to make changes in specifications and features shown without notice or obligation.

U5890-X-2/150-HSP20	U3862.....5	U9550-RRL-QG-HSP.....11
U5890-X-2/200-HSP20	U3949-X-HSP.....14	U9551-X-QG-HSP.....11
U1129-O-K3L-K2L-HSP.....13	U4363-X-HSP.....13	U9700-RRL-QG-HSP.....12
U1232-X-HSP.....23	U4667-X-852816	U9701-X-QG-HSP.....12
U1233-X-HSP.....23	U4667-X-9526.....16	U9801-X-HSP.....11
U1234-X-HSP.....23	U4881-O.....7	UA4667-X-852916
U1235-X-HSP.....23	U4881-O-50GB.....7	UA4667-X-952716
U1236-X-HSP.....23	U4881-O-60GB.....7	UAP1252-X-HSP24
U1252-X-HSP.....24	U4908-O-11GR-HSP28	UAP1253-X-HSP24
U1253-X-HSP.....24	U5101-XL-11GR-HSP28	UAP1254-X-HSP24
U1254-X-HSP.....24	U5136-O-100P-FMG30	UAP1255-X-HSP24
U1255-X-HSP.....24	U5136-O-100S-FMG30	UAP1256-X-HSP24
U1256-X-HSP.....24	U5136-O-125P-FMG30	UAP2124-O-HSP13
U1797-O-K3L-K2L-HSP.....13	U5136-O-125S-FMG30	UAP3296-X-HSP11
U1980-O-5T-HSP9	U5136-O-150P-FMG30	UAP3306-X-HSP12
U1980-O-HSP9	U5136-O-150S-FMG30	UAP3505-XL-TG-HSP10
U2120-O-HSP15	U5136-O-200P-FMG30	UAP3506-XL-TG-HSP10
U2124-O-HSP13	U5136-O-200S-FMG29	UAP3566-X-HSP15
U2732-X-HSP26	U5136-O-200S-FMG30	UAP3949-X-HSP14
U2733-X-HSP26	U5136-O-FMG.....30	UAP5024-XL-FMG18
U2734-X-HSP26	U5137-O-100P-FMG30	UAP5864-X-HSP14
U2735-X-HSP26	U5137-O-100S-FMG30	UAP7021-RL-TG-HSP.....9
U2736-X-HSP26	U5137-O-125P-FMG30	UAP7040-O-TG-HSP9
U2852-X-HSP.....27	U5137-O-125S-FMG30	UAP7040-XL-TG-5T-HSP.....9
U2853-X-HSP.....27	U5137-O-150P-FMG30	UAP7040-XL-TG-HSP9
U2854-X-HSP.....27	U5137-O-150S-FMG30	UAP8435-XL-TG-5T-HSP.....8
U2855-X-HSP.....27	U5137-O-200P-FMG30	UAP8435-XL-TG-HSP8
U2856-X-HSP.....27	U5137-O-200S-FMG30	UAP9551-X-QG-HSP11
U2862-X-HSP.....27	U5137-O-FMG.....30	UAP9700-RRL-QG-HSP12
U2863-X-HSP.....27	U5842-RL-100-HSP.....18	UAP9701-X-QG-HSP12
U2864-X-HSP.....27	U5842-RL-150-HSP.....18	Z703916-AC17
U2865-X-HSP.....27	U5842-RL-200-HSP.....18	Z703917-AC17
U2866-X-HSP.....27	U5864-X-HSP.....14	Z703918-AC17
U2872-X-HSP.....25	U5891-X-2/200-MLK-HSP.20	Z703919-AC17
U2873-X-HSP.....25	U6115-X-2/200-K7L-HSP .21	Z703921-AC17
U2874-X-HSP.....25	U6227-X-400-K3L-HSP21	Z704693-AC17
U2875-X-HSP.....25	U6229-X-400-K3L-HSP21	Z704693-AC17
U2876-X-HSP.....25	U6266-XTL-100-HSP.....19	Z704694-AC17
U3296-X-HSP.....11	U6266-XTL-150-HSP.....19	Z705420-AC17
U3306-X-HSP.....12	U6266-XTL-200-HSP.....19	Z705456-AC17
U3492-XL-HSP.....22	U6267-X-2/150-HSP20	Z708145-AC17
U3493-XL-HSP.....22	U6267-X-2/200-HSP20	
U3494-XL-HSP.....22	U6267-X-HSP20	
U3495-XL-HSP.....22	U6272-X-HSP.....13	
U3496-XL-HSP.....22	U6273-X-HSP.....13	
U3505-XL-TG-HSP10	U6396-O-100-10GR-HSP..31	
U3506-XL-TG-HSP.....10	U6396-O-200-10GR-HSP..31	
U3566-X-HSP.....15	U7021-RL-TG-HSP.....9	
U3802.....5	U7040-O-TG-HSP.....9	
U3812.....5	U7040-XL-TG-5T-HSP.....9	
U3822-20GWR.....6	U7040-XL-TG-HSP.....9	
U3832.....5	U8435-XL-TG-5T-HSP.....8	
U3850-XL-TG-HSP-PL.....9	U8435-XL-TG-HSP.....8	

Please consult serving utility for their requirements prior to ordering or installing, as specifications and approvals vary by utility, and may require local electrical inspector approval. All installations must be installed by a licensed electrician and must comply with all national and local codes, laws and regulations. Milbank reserves the right to make changes in specifications and features shown without notice or obligation.



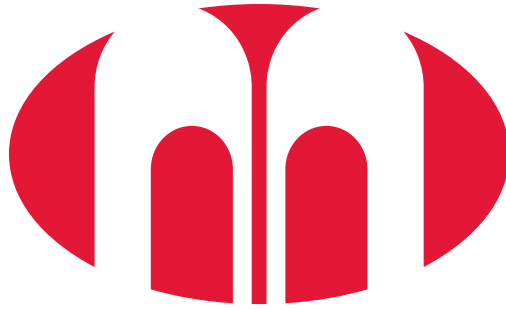

MILBANK[®]

ENERGY AT WORK

