

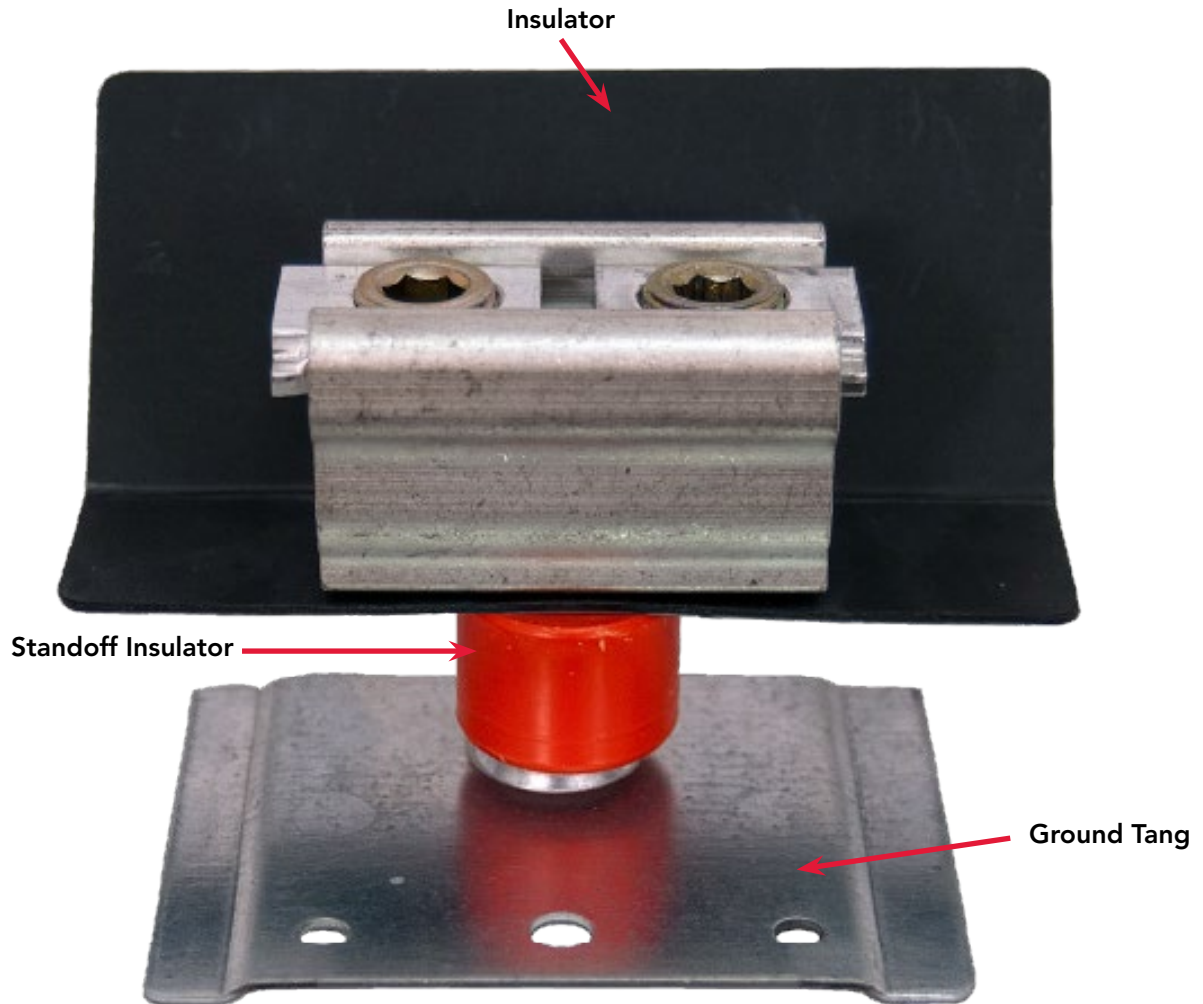

Isolated Neutral Kits

All kits include isolating blocks and hardware to be installed under existing neutral bar



K1047

Please consult serving utility for their requirements prior to ordering or installing, as specifications and approvals vary by utility, and may require local electrical inspector approval. All installations must be installed by a licensed electrician and must comply with all national and local codes, laws and regulations. Milbank reserves the right to make changes in specifications and features shown without notice or obligation.





Isolated Neutral Kits

All kits include isolating blocks and hardware to be installed under existing neutral bar

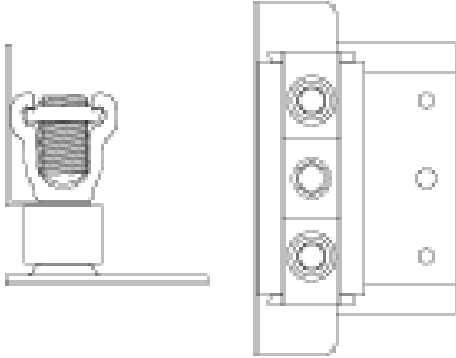

K1047

K1047

200 Amps

For use with the following series:

1854, 2046, 2145, 2810, 3061, 3328, 4701,
4788, 4910, 5127, 7422, 7423, 8606, 9701, 9707

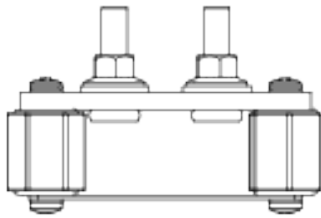
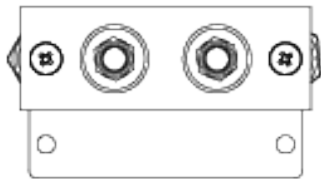

K5977

K5977

320 Amps

For use with the following series:

2120, 2448, 2594, 2827, 4013, 4168, 4257,
4260, 4487, 4596, 4741, 4776, 4980, 5036

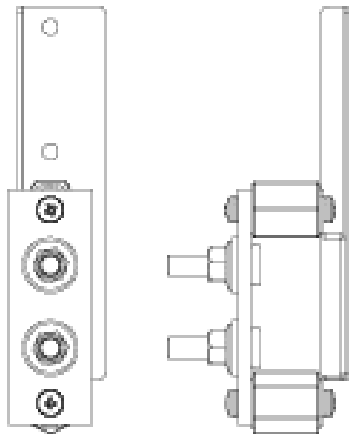

K5978

K5978

320 Amps

For use with the following series:

1129*, 1729, 1797, 1897, 3000

*Cannot be used on U1129 with -MVE suffix

Please consult serving utility for their requirements prior to ordering or installing, as specifications and approvals vary by utility, and may require local electrical inspector approval. All installations must be installed by a licensed electrician and must comply with all national and local codes, laws and regulations. Milbank reserves the right to make changes in specifications and features shown without notice or obligation.





Isolated Neutral Kits

All kits include isolating blocks and hardware to be installed under existing neutral bar

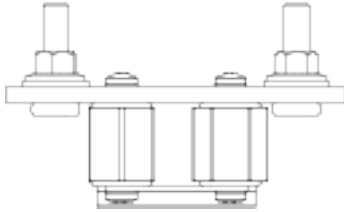
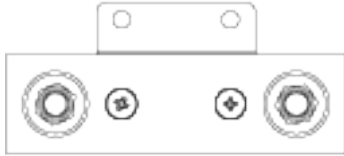

K5979

K5979

320 Amps

For use with the following series:

4505, 4702, 5740

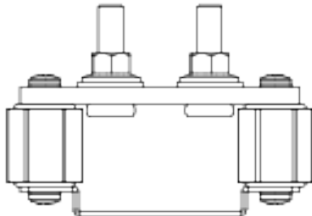

K5980

K5980

320 Amps

For use with the following series:

5161

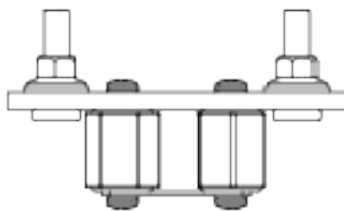
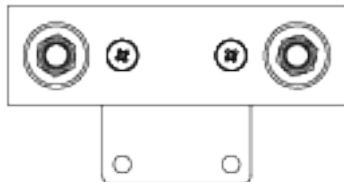

K5984

K5984

320 Amps

For use with the following series:

4342, 4362, 4778, 4911, 5786

Please consult serving utility for their requirements prior to ordering or installing, as specifications and approvals vary by utility, and may require local electrical inspector approval. All installations must be installed by a licensed electrician and must comply with all national and local codes, laws and regulations. Milbank reserves the right to make changes in specifications and features shown without notice or obligation.





Isolated Neutral Kits

All kits include isolating blocks and hardware to be installed under existing neutral bar



K5985

320 Amps

For use with the following series:

1432, 4905, 5155

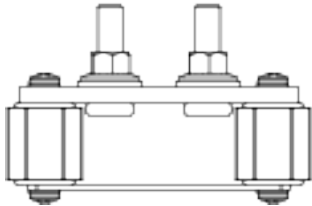

K5979

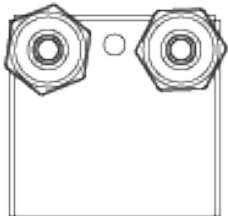

K5986

320 Amps

For use with the following series:

4363, 4741, 5052

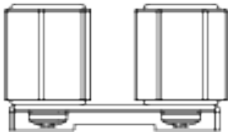

K5980

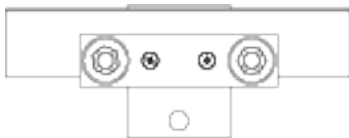

K6024

320 Amps

For use with the following series:

3566



K5984

Please consult serving utility for their requirements prior to ordering or installing, as specifications and approvals vary by utility, and may require local electrical inspector approval. All installations must be installed by a licensed electrician and must comply with all national and local codes, laws and regulations. Milbank reserves the right to make changes in specifications and features shown without notice or obligation.

