

MILBANK[®]
ENERGY AT WORK



REC Municipal

Meter Mounting Equipment



Milbank Overview

Energy At Work since 1927

Milbank designs and manufactures electrical solutions that move and manage power for the residential, commercial, industrial, utility and transportation sectors. With 90 years of expertise in electrical engineering design and manufacturing, Milbank's portfolio includes metering equipment, enclosures and enclosed controls. Founded in 1927, Milbank is a family-owned, American manufacturer headquartered in Kansas City, Mo. For more information, please visit milbankworks.com.

METERING



As a market leader in electrical metering equipment, Milbank has set the standard for quality since 1927. Hundreds of configurations are available, including many sizes, knockout configurations, terminal configurations, bypass options, hubs, locks and connectors. Milbank has the socket you need with thousands of active products to meet your utility's requirements.

ENCLOSURES



Milbank's line of enclosures include commercial junction boxes, panel mount enclosures, transformer cabinets, wireway, and trough. Built with high-quality craftsmanship and materials which meet or exceed industry standards, Milbank enclosures are made to protect controls and equipment from dust, dirt and other harmful elements found in a wide variety of environments.

ENCLOSED CONTROLS



Milbank doesn't just build empty enclosures. We can deliver the entire package, complete with custom control equipment built to your exact specifications by our engineers. Milbank commercial pedestals are an attractive, secure, easy to install and cost-effective solution when underground remote site power distribution and control equipment is required, replacing unsightly and inefficient strut and backboard structures.



Please consult serving utility for their requirements prior to ordering or installing, as specifications and approvals vary by utility, and may require local electrical inspector approval. All installations must be installed by a licensed electrician and must comply with all national and local codes, laws and regulations. Milbank reserves the right to make changes in specifications and features shown without notice or obligation.

Air Conditioner Disconnects

30-60 amp AC disconnects	6
60 amp AC disconnect with 20 amp GFCI receptacle	7

Single Position Sockets

100-200 amp, 4 terminals, ringless	8-10
200 amp, 4 & 7 terminals, lever bypass, ringless	11
200 amp, 4 & 5 terminals, heavy duty lever bypass, ringless	12
200 amp, 7 terminals, heavy duty lever bypass, ringless	13
320 amp, 4 & 5 terminals, lever bypass, ringless	14
320 amp, 4 terminals, lever bypass, side wireway, ringless	15
320 amp, 7 terminals, lever bypass, side wireway, ringless	16

Meter Mains

100 amp, 4 terminals, ringless & ringtype	17
100-200 amp, 4 terminals, ringless & ringtype	18

Triple Tap Meter Mains

100-200 amp, 4 terminals, ringless	19
--	----

Meter Main with Load Center

100-200 amp, 4 terminals, ringless & ringtype	20-22
---	-------

Lever Bypass Meter Main

200 amp, 4 & 7 terminals, ringless	23
320 amp, 4 terminals, ringless, 2/200A Breakers	24
320 amp, 4 terminals, ringless, 400A Breaker	25

Cold Sequence Meter Main

200 amp, 4, 5 & 7 terminals, ringless & ringtype	26
--	----

Multi-Position

100 amp, 4 terminals, ringless	27
200 amp, 4 terminals, ringless	28
200 amp, 5 terminals, lever bypass, ringless	29
200 amp, 7 terminals, lever bypass, ringless	30

Please consult serving utility for their requirements prior to ordering or installing, as specifications and approvals vary by utility, and may require local electrical inspector approval. All installations must be installed by a licensed electrician and must comply with all national and local codes, laws and regulations. Milbank reserves the right to make changes in specifications and features shown without notice or obligation.



Multi-Position Meter Main Sockets

125-200 amp, 4 terminals, ringless	31-34
--	-------

Lever Bypass Multi-Position Meter Main

200 amp, 5 terminals, ringless, vertical.....	35
200 amp, 4 terminals, ringless, horizontal 22KAIC	36-37

Transformer Rated

20 amp, 5-13 terminals, ringless	38-39
20 & 80 amp, 6, 8, & 13 terminals, ringless	40

Milbank Test Switches

Test Switches	41
Current Transformer Switches	42
Test Switch Worksheet	43

Transformer Cabinets

Transformer Cabinets	44-45
CT Mounting Racks	46

Transockets

400 & 600 amp, 6 -14 Terminal	47-49
-------------------------------------	-------

Pedestals

Residential, 200 amp, 4 terminal, horn bypass	50
100-200 amp, 5 & 7 terminal, with lever bypass, ringless	51
100-200 amp, 4 terminal, with meter main w/ Load Center, ringless	52-56
200 amp, 4 terminal, Curbside Meter Pedestal, ringless	58
320 amp continuous, 400 amp max, 4 terminal, Lever Bypass	59
Instrument Rated	60

Miscellaneous

Terminal Box	61
Tap Box	62-63
Commercial Meter Pedestals	64-73
Circuit Breakers	74
Accessories	75-78
NEMA Commercial Enclosures.....	79
Reference information	80-85
Index.....	86-87



Please consult serving utility for their requirements prior to ordering or installing, as specifications and approvals vary by utility, and may require local electrical inspector approval. All installations must be installed by a licensed electrician and must comply with all national and local codes, laws and regulations. Milbank reserves the right to make changes in specifications and features shown without notice or obligation.

Catalog Number Logic

How our product catalog numbers are derived

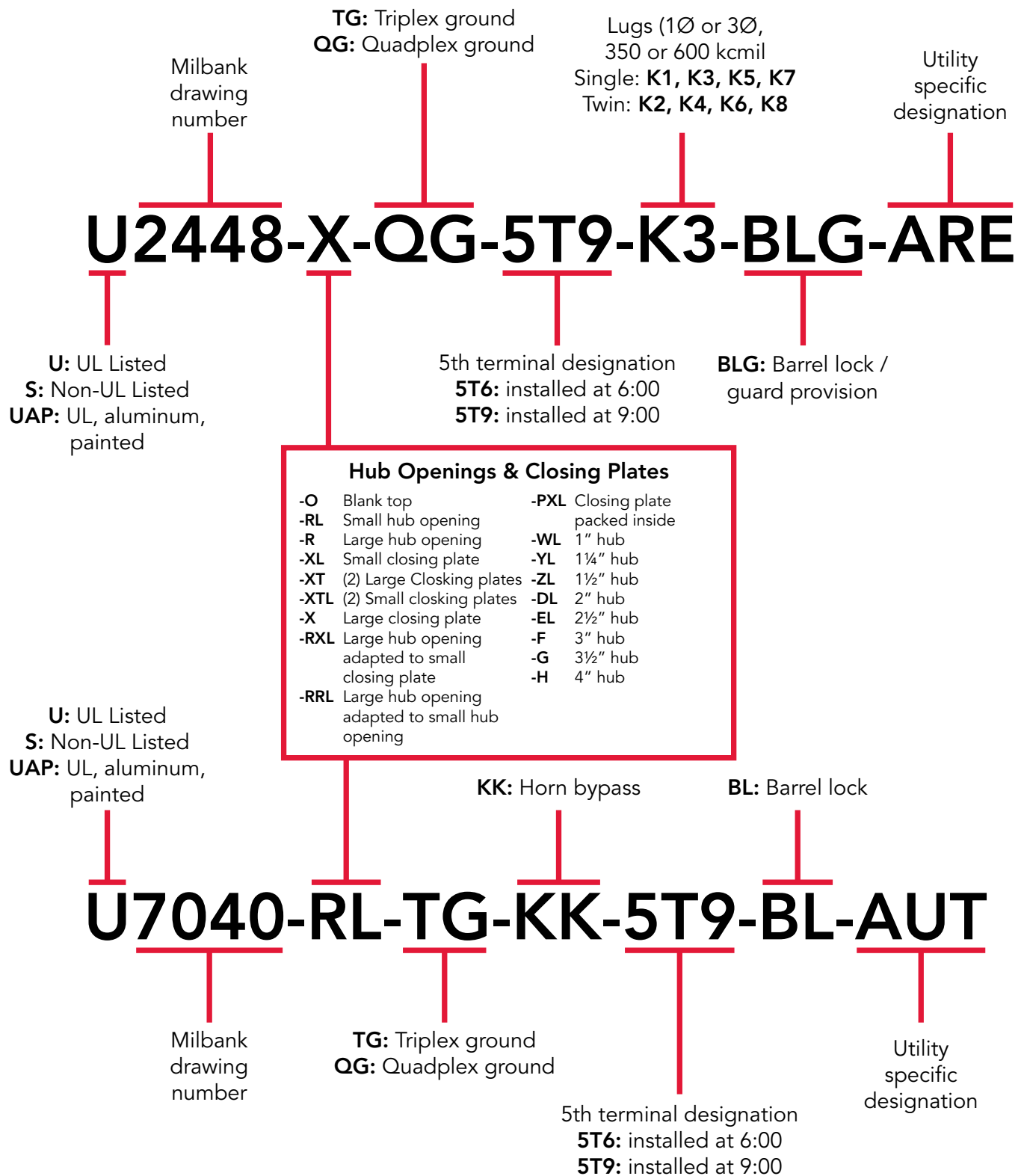

Please consult serving utility for their requirements prior to ordering or installing, as specifications and approvals vary by utility, and may require local electrical inspector approval. All installations must be installed by a licensed electrician and must comply with all national and local codes, laws and regulations. Milbank reserves the right to make changes in specifications and features shown without notice or obligation.



Air Conditioner Disconnects

30-60 Amp | Fusible & Non-Fusible



U3802



U3812



U3832

Milbank’s air conditioner disconnect has a removable hinged cover for ease of installation. Our compact design meets NEC wiring space requirements and also complies with NEC article 440-14. For safe working conditions, our disconnect pullers may be removed and reinstalled in the OFF position. Additionally, padlock provisions are included on the front cover. As with other Milbank products, our enclosure is constructed of G90U galvanized steel and electrostatically finished with an attractive, light gray, baked powder coating. Our epoxy/polyester resin blend offers a finish that is both durable and fade-resistant.

30–60 Amp | 1Ø 240 VAC | Air Conditioner Disconnects

Catalog Number	Amp	Type	Max H.P.	Weight (lbs.)	Line/Load Wire Range		Ground Wire Range CU/AL	Dimensions			Wire Rating	
					CU	AL		D"	W"	H"	CU °C	AL °C
U3802	60	Non-Fusible	10	3.25	#14-#2	#12-#2	#14-4	2½	5	7½	60°/75°	60°/75°
U3812	60	Non-Auto	10	3.25	#14-#2	#12-#2	#14-4	2½	5	7½	60°/75°	60°/75°
U3832	30	Fusible	3	2.5	#14-#3	#14-#3	#14-3	2½	5	7	60°/75°	60°/75°
U3862	60	Fusible	10	3.3	#14-#3	#14-#3	#14-3	2½	5	9	60°/75°	60°/75°

Notes

- UL listed as Enclosed Pullout Switch
- Type 3R rain resistant
- One-inch concentric knockouts



Please consult serving utility for their requirements prior to ordering or installing, as specifications and approvals vary by utility, and may require local electrical inspector approval. All installations must be installed by a licensed electrician and must comply with all national and local codes, laws and regulations. Milbank reserves the right to make changes in specifications and features shown without notice or obligation.

Air Conditioner Disconnects

20 Amp GFCI Receptacle



U3822-20GWR

Specifications

- Meets NEC #210.63 requirements
- UL listed as Power Outlet
- Type 3R enclosure
- In-use cover*
- Duplex ground connector
- 1" concentric knockouts
- 1Ø, 240 volt
- 60 amp, non-fused
- 20 amp GFCI receptacle
- Reset/test button
- Weather and tamper resistant
- Meets NEC #406.8 requirements

60 Amp | 1Ø, 240 VAC | Air Conditioner Disconnect with GFCI Receptacle

Catalog Number	Type	Max H.P.	Weight (lbs.)	Line/Load Wire Range		Ground Wire Range CU/AL	Dimensions			Wire Rating	
				CU	AL		D"	W"	H"	CU °C	AL °C
U3822-20GWR	Non-Fusible	10	6	#14-#2	#12-#2	#14-4	4 $\frac{1}{8}$	5 $\frac{1}{4}$	7 $\frac{1}{2}$	60°/75°	60°/75°

Notes

- **Disconnect Pullers:** To ensure the safest conditions, Milbank disconnect pullers are reversible so they may be reinstalled in the OFF position.
- **Padlock Provision:** All units are designed with a padlock provision on the cover for security.
- ***In-Use Cover:** Cover is rated as an in-use cover (cover may be closed with cords plugged into receptacle).

Please consult serving utility for their requirements prior to ordering or installing, as specifications and approvals vary by utility, and may require local electrical inspector approval. All installations must be installed by a licensed electrician and must comply with all national and local codes, laws and regulations. Milbank reserves the right to make changes in specifications and features shown without notice or obligation.



8

100-125 AMP
SINGLE
POSITION

Single Position Sockets

4 Terminal | 100 & 125 Amp



U7487-RL-TG

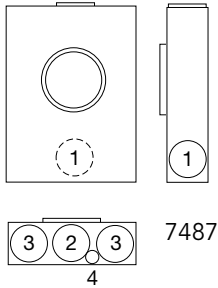

U5934-XL-BLG

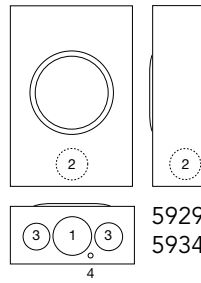

U7490-RL-TG

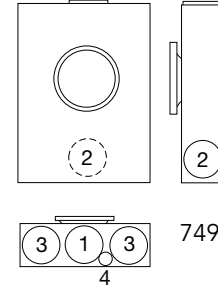

4 Terminal | Single Position | Ringless

Catalog Number	Amp	Service	Hub	Connectors CU/AL		Bypass	Dimensions			Knockouts			
				Line	Load		D"	W"	H"	1	2	3	4
U7487-RL-TG	125	OH/UG	H.O.	#6-2/0	#6-2/0	None	3 ⁵ / ₁₆	8	11 ¹ / ₂	2	1 ¹ / ₂	1 ¹ / ₄	1 ¹ / ₄
U7487-RL-TG-KK	125	OH/UG	H.O.	#6-2/0	#6-2/0	Horn	3 ⁵ / ₁₆	8	11 ¹ / ₂	2	1 ¹ / ₂	1 ¹ / ₄	1 ¹ / ₄
U5934-XL-BLG	100	OH/UG	C.P.	#12-1/0	#12-1/0	None	3 ⁵ / ₁₆	8	11 ¹ / ₂	2	1 ¹ / ₂	1 ¹ / ₄	1 ¹ / ₄

4 Terminal | Single Position | Ring Type

Catalog Number	Amp	Service	Hub	Connectors CU/AL		Bypass	Dimensions			Knockouts			
				Line	Load		D"	W"	H"	1	2	3	4
U7490-RL-TG	125	OH/UG	H.O.	#6-2/0	#6-2/0	None	3 ⁵ / ₁₆	8	11 ¹ / ₂	2	1 ¹ / ₂	1 ¹ / ₄	1 ¹ / ₄
U5929-XL	100	OH/UG	C.P.	#12-1/0	#12-1/0	None	3 ⁵ / ₁₆	8	11 ¹ / ₂	2	1 ¹ / ₂	1 ¹ / ₄	1 ¹ / ₄

Notes

- **Fifth Terminal:** For field mounted fifth terminal on the **U7487** & **U7490** order catalog number **5T8K2** to fit into round opening at the 9 o'clock position.
- **Hubs:** For proper hub selection see the hub suffix chart on the accessory page.
- **Connectors:** Extruded aluminum connectors are tin plated.
- **Sealing Rings:** Ring type units supplied with an **MR-2** snap action sealing ring as standard.
- **Isolated Neutral:** **U5929** and **U5934** include isolated neutral option.



Please consult serving utility for their requirements prior to ordering or installing, as specifications and approvals vary by utility, and may require local electrical inspector approval. All installations must be installed by a licensed electrician and must comply with all national and local codes, laws and regulations. Milbank reserves the right to make changes in specifications and features shown without notice or obligation.

Single Position Sockets

200 Amp | 4 Terminal | Ringless

9
200 AMP
SINGLE
POSITION



U7040-RL-TG

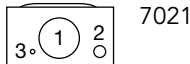
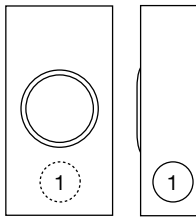

7021



U4532-XL

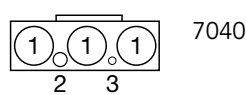
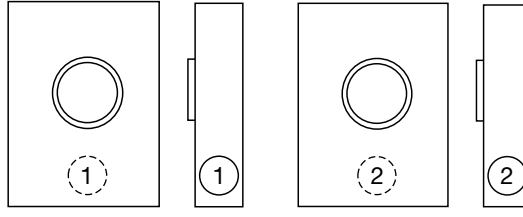

7040

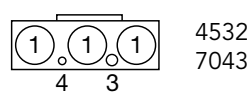
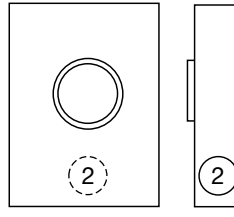

4532
7043



U1980-O

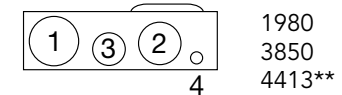
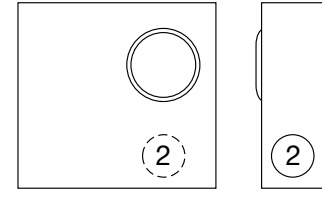

1980
3850
4413**

200 Amp | 4 Terminal | Single Position | Ringless

Catalog Number	Service	Hub	Connectors CU/AL		Bypass	Dimensions			Knockouts			
			Line	Load		D"	W"	H"	1	2	3	4
U7021-RL-TG	OH	H.O.	#6-350	#6-350	None*	4 $\frac{1}{8}$	8	15 $\frac{1}{2}$	2 $\frac{1}{2}$	$\frac{1}{4}$, $\frac{1}{2}$	$\frac{1}{4}$	—
U7040-RL-TG	OH/UG	H.O.	#6-350	#6-350	None*	4 $\frac{1}{8}$	11	14 $\frac{1}{2}$	2 $\frac{1}{2}$	$\frac{1}{4}$, $\frac{1}{2}$	$\frac{1}{4}$	—
U7043-XL-TG	OH/UG	C.P.	#6-350	#6-350	None*	4 $\frac{7}{8}$	13	15 $\frac{1}{2}$	3	2 $\frac{1}{2}$	$\frac{1}{4}$, $\frac{1}{2}$	$\frac{1}{4}$
U4532-XL	OH/UG	C.P.	#6-350	Dual #6-350	None	4 $\frac{7}{8}$	15	20 $\frac{1}{2}$	3	2 $\frac{1}{2}$	$\frac{1}{4}$, $\frac{1}{2}$	$\frac{1}{4}$
U3850-O-TG	UG	Blank	#6-350	#6-350	None*	4 $\frac{1}{2}$	13	15 $\frac{1}{4}$	3	2 $\frac{1}{2}$	1 $\frac{1}{2}$	$\frac{1}{4}$, $\frac{1}{2}$
U1980-O	UG	Blank	#6-350	#6-350	None*	4 $\frac{1}{2}$	13	15 $\frac{1}{4}$	3	2 $\frac{1}{2}$	1 $\frac{1}{2}$	$\frac{1}{4}$, $\frac{1}{2}$
U4413-O**	UG	Blank	#6-350	#6-350	None*	4 $\frac{1}{2}$	13	15 $\frac{1}{4}$	2 $\frac{1}{2}$	$\frac{1}{4}$, $\frac{1}{2}$	$\frac{1}{4}$	—

Notes

- **Fifth Terminal:** For field mounted fifth terminal, order catalog number **K5T** to fit into square opening at the 9 o'clock position.
- **Connectors:** Extruded aluminum connectors are tin plated. Units are supplied with triplex ground.
- ***Bypass:** Horn type bypass is available. Add suffix **-KK**.
- ****U4413:** Design is mirror image of **U1980** with left meter position.

Please consult serving utility for their requirements prior to ordering or installing, as specifications and approvals vary by utility, and may require local electrical inspector approval. All installations must be installed by a licensed electrician and must comply with all national and local codes, laws and regulations. Milbank reserves the right to make changes in specifications and features shown without notice or obligation.



Single Position Sockets

200 Amp | 4 Terminal | Ring Type



U7017-RL-TG



U7018-XL-TG



U4015-O

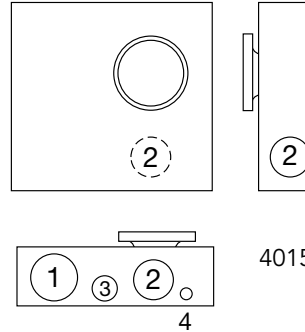
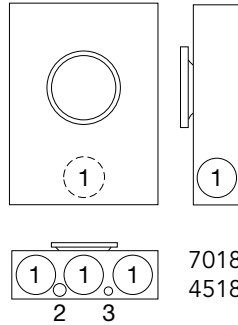
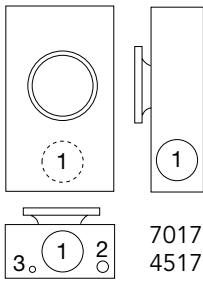

200 Amp | 4 Terminal | Single Position | Ring Type

Catalog Number	Service	Hub	Connectors CU/AL		Dimensions			Knockouts			
			Line	Load	D"	W"	H"	1	2	3	4
U7017-RL-TG	OH	H.O.	#6-350	#6-350	4 $\frac{1}{8}$	8	15 $\frac{1}{2}$	2 $\frac{1}{2}$	$\frac{1}{4}$, $\frac{1}{2}$	$\frac{1}{4}$	—
U7018-XL-TG	OH/UG	C.P.	#6-350	#6-350	4 $\frac{1}{8}$	11	15 $\frac{1}{2}$	2 $\frac{1}{2}$	$\frac{1}{4}$, $\frac{1}{2}$	$\frac{1}{4}$	—
U4517-DL-M4	OH	2"	#6-350	#6-350	4 $\frac{1}{8}$	8	15 $\frac{1}{2}$	2 $\frac{1}{2}$	$\frac{1}{4}$, $\frac{1}{2}$	$\frac{1}{4}$	—
U4518-O-W	UG	Blank	#6-350	#6-350	4 $\frac{1}{8}$	11	15 $\frac{1}{2}$	2 $\frac{1}{2}$	2	$\frac{1}{4}$, $\frac{1}{2}$	$\frac{1}{4}$
U4015-O	UG	Blank	#6-350	#6-350	6	14	16 $\frac{1}{4}$	3	2 $\frac{1}{2}$	1 $\frac{1}{2}$	$\frac{1}{4}$, $\frac{1}{2}$

Notes

- **Fifth Terminal:** For field mounted fifth terminal, order catalog number **K5T** to fit into square opening at the 9 o'clock position.
- **Hubs:** For the proper hub selection see the hub suffix chart on the accessories page.
- **Triples Ground (-TG):** Factory installed.
- **Sealing Rings:** Ring-type units are supplied with **MR-2** snap action sealing rings as standard.



Please consult serving utility for their requirements prior to ordering or installing, as specifications and approvals vary by utility, and may require local electrical inspector approval. All installations must be installed by a licensed electrician and must comply with all national and local codes, laws and regulations. Milbank reserves the right to make changes in specifications and features shown without notice or obligation.

Single Position Lever Bypass

200 Amp | 4 & 7 Terminal | Medium Duty

1 1
200 AMP
SINGLE
POSITION
LEVER BYPASS



U1207-RL

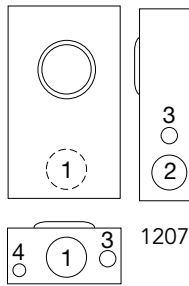

U7423-RXL

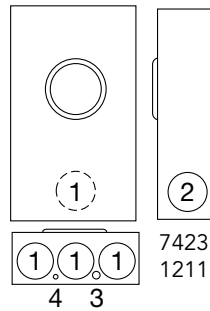

U3328-RXL

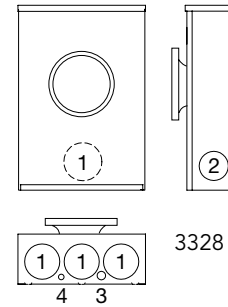

200 Amp | 4 Terminal | Single Position | Non Jaw Clamping Lever Bypass | Ringless

Catalog Number	Service	Hub	Connectors CU/AL		Bypass	Dimensions			Knockouts			
			Line	Load		D"	W"	H"	1	2	3	4
U1207-RL	OH	H.O.	#6-350	#6-350	Lever	4 $\frac{7}{8}$	10	18 $\frac{1}{2}$	3	2 $\frac{1}{2}$	$\frac{3}{4}$	1 $\frac{1}{4}$, $\frac{1}{2}$
U1211-RXL	OH/UG	C.P.	#6-350	#6-350	Lever	4 $\frac{7}{8}$	13	19	3	2 $\frac{1}{2}$	1 $\frac{1}{4}$, $\frac{1}{2}$	$\frac{1}{4}$

200 Amp | 7 Terminal | Single Position | Non Jaw Clamping Lever Bypass | Ringless

Catalog Number	Service	Hub	Connectors CU/AL		Bypass	Dimensions			Knockouts			
			Line	Load		D"	W"	H"	1	2	3	4
U7423-RXL	OH/UG	C.P.	#6-350	#6-350	Lever	4 $\frac{1}{2}$	13	19	3	2 $\frac{1}{2}$	1 $\frac{1}{4}$, $\frac{1}{2}$	$\frac{1}{4}$

200 Amp | 7 Terminal | Single Position | Ring Type | No Lever Bypass

Catalog Number	Service	Hub	Connectors CU/AL		Bypass	Dimensions			Knockouts			
			Line	Load		D"	W"	H"	1	2	3	4
U3328-RXL	OH/UG	C.P.	#6-350	#6-350	None	4 $\frac{7}{8}$	13	19	3	2 $\frac{1}{2}$	1 $\frac{1}{4}$, $\frac{1}{2}$	$\frac{1}{4}$

Notes

- **Fifth Terminal:** For field mounted fifth terminal, order as extra **K3866** for the **U1207** or **U1211**.
- **Connectors:** Units are supplied with extruded aluminum connectors.
- **Bypass:** Lever operates bypass device only; does not provide clamping action on meter spades.

Please consult serving utility for their requirements prior to ordering or installing, as specifications and approvals vary by utility, and may require local electrical inspector approval. All installations must be installed by a licensed electrician and must comply with all national and local codes, laws and regulations. Milbank reserves the right to make changes in specifications and features shown without notice or obligation.



Single Position Lever Bypass

200 Amp | 4 & 5 Terminal | Heavy Duty | Jaw Clamping



U9800-RRL

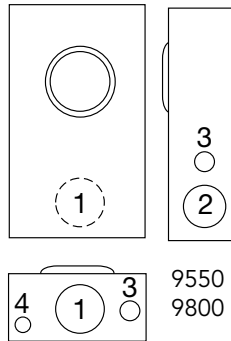

9550
9800



U9551-RXL

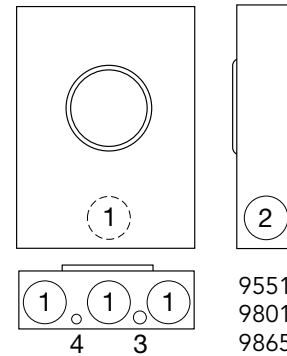

9551
9801
9865
9581

200 Amp | 4 Terminal | Single Position | Lever Bypass | 1Ø3W | Ringless

Catalog Number	Service	Hub	Connectors CU/AL		Bypass	Dimensions			Knockouts			
			Line	Load		D"	W"	H"	1	2	3	4
U9800-RRL	OH	H.O.	#6-350	#6-350	Lever	4 ⁷ / ₈	10	18 ¹ / ₂	3	2 ¹ / ₂	³ / ₄	¹ / ₄ , ¹ / ₂
U9801-RXL	OH/UG	C.P.	#6-350	#6-350	Lever	4 ⁷ / ₈	13	19	3	2 ¹ / ₂	¹ / ₄ , ¹ / ₂	¹ / ₄
U9865-RRL	OH/UG	H.O.	³ / ₈ x 16 Stud	³ / ₈ x 16 Stud	Lever	4 ⁷ / ₈	13	28 ¹ / ₄	3	2 ¹ / ₂	¹ / ₄ , ¹ / ₂	¹ / ₄

200 Amp | 5 Terminal | Single Position | Lever Bypass | 1Ø3W or 3Ø3W | Ringless

Catalog Number	Service	Hub	Connectors CU/AL		Bypass	Dimensions			Knockouts			
			Line	Load		D"	W"	H"	1	2	3	4
U9550-RRL	OH	H.O.	#6-350	#6-350	Lever	4 ⁷ / ₈	10	18 ¹ / ₂	3	2 ¹ / ₂	³ / ₄	¹ / ₄ , ¹ / ₂
U9551-RXL	OH/UG	C.P.	#6-350	#6-350	Lever	4 ⁷ / ₈	13	19	3	2 ¹ / ₂	¹ / ₄ , ¹ / ₂	¹ / ₄

200 Amp | 5 Terminal | Single Position | Center Disconnect | 1Ø3W or 3Ø3W | Ringless

Catalog Number	Service	Hub	Connectors CU/AL		Bypass	Dimensions			Knockouts			
			Line	Load		D"	W"	H"	1	2	3	4
U9581-RXL-QG	OH/UG	C.P.	#6-350	#6-350	Lever	4 ⁷ / ₈	13	19	3	2 ¹ / ₂	¹ / ₄ , ¹ / ₂	¹ / ₄

Notes

- **Fifth Terminal:** For field-installed fifth terminal, order catalog number **K3866**. May be installed in 6 o'clock or 9 o'clock position.
- **Hubs:** For proper hub selection see the hub suffix chart on the accessory page.
- **Connectors:** Extruded aluminum connectors are tin plated. **U9550**, **U9551**, **U9800** and **U9801** units include removable bonding strap for isolated neutral.
- **Bypass:** Lever supplies clamping action and also operates bypass device.
- **Center Disconnect:** Contains manual center disconnect for **U9581**.



Please consult serving utility for their requirements prior to ordering or installing, as specifications and approvals vary by utility, and may require local electrical inspector approval. All installations must be installed by a licensed electrician and must comply with all national and local codes, laws and regulations. Milbank reserves the right to make changes in specifications and features shown without notice or obligation.

Single Position Lever Bypass

200 Amp | 7 Terminal | Heavy Duty | Jaw Clamping

13
200 AMP
SINGLE
POSITION
LEVER BYPASS



U9701-RXL

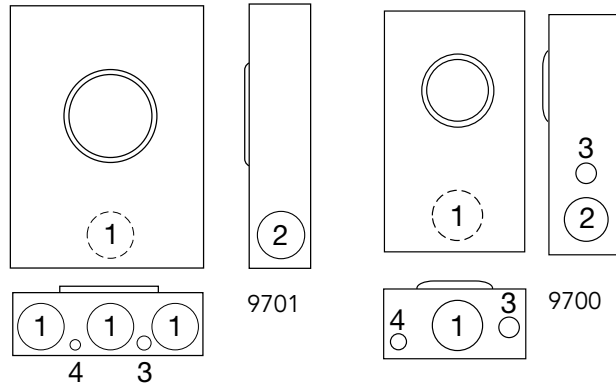

200 Amp | 7 Terminal | Single Position | Lever Bypass | 3Ø4W | Ringless

Catalog Number	Service	Hub	Connectors CU/AL		Bypass	Dimensions			Knockouts			
			Line	Load		D"	W"	H"	1	2	3	4
U9700-RRL	OH	H.O.	#6-350	#6-350	Lever	4 ⁷ / ₈	10	18 ¹ / ₂	3	2 ¹ / ₂	3/4	1/4, 1/2
U9701-RXL	OH/UG	C.P.	#6-350	#6-350	Lever	4 ⁷ / ₈	13	19	3	2 ¹ / ₂	1/4, 1/2	1/4

Notes

- **Hubs:** For proper hub selection see the hub suffix chart on the accessory page.
- **Connectors:** Extruded aluminum connectors are tin plated.
- **Bypass:** Lever supplies clamping action and also operates bypass device.

Please consult serving utility for their requirements prior to ordering or installing, as specifications and approvals vary by utility, and may require local electrical inspector approval. All installations must be installed by a licensed electrician and must comply with all national and local codes, laws and regulations. Milbank reserves the right to make changes in specifications and features shown without notice or obligation.



Single Position Lever Bypass

320 Amp | 4 & 5 Terminal | Ringless | Jaw Clamping



U1079-R

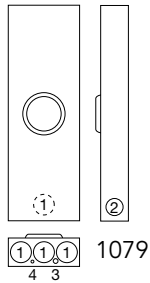

U4505-X

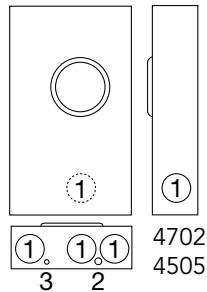

U1129-O-K3L-K2L

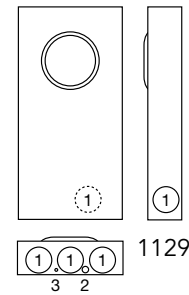

320 Amp | 4 & 5 Terminal | Single Position | Lever Bypass | Ringless

Catalog Number	Terminals	Service	Hub	Connectors CU/AL		Bypass	Dimensions			Knockouts			
				Line	Load		D"	W"	H"	1	2	3	4
U1079-R	4	OH	H.O.	3/8" x 16 Stud	3/8" x 16 Stud	Lever	4 7/8	13	38 3/4	3	2 1/2	1/4, 1/2	1/4
U1779-RRL-K3-K2	4	OH	H.O.	(1) #4-600 or (2) 1/0-250	(2) #6-350	Lever	4 7/8	13	38 3/4	3	2 1/2	1/4, 1/2	1/4
U4702-X	4	OH/UG	C.P.	3/8" x 16 Stud	3/8" x 16 Stud	Lever	4 7/8	15	28 1/4	3	1/4, 1/2	1/4	—
U1129-O-K3L-K2L	4	UG	Blank	(1) #4-600 or (2) 1/0-250	(2) #6-350	Lever	4 7/8	15	30	3	1/4, 1/2	1/4	—
U4505-X	5	OH/UG	C.P.	3/8" x 16 Stud	3/8" x 16 Stud	Lever	4 7/8	15	28 1/4	3	1/4, 1/2	1/4	—

Notes

- **Hubs:** For proper hub selection see the hub suffix chart on the accessory page.
- **Bypass:** Lever supplies clamping action on meter spades and also operates bypass device.
- **Fifth Terminal:** For field-installed fifth terminal, order catalog number **K3866** for **U1079** and **K3865** for **U1129**, and the **U4702**. May be installed in 6 o'clock or 9 o'clock position.



Please consult serving utility for their requirements prior to ordering or installing, as specifications and approvals vary by utility, and may require local electrical inspector approval. All installations must be installed by a licensed electrician and must comply with all national and local codes, laws and regulations. Milbank reserves the right to make changes in specifications and features shown without notice or obligation.

Single Position Lever Bypass

320 Amp | 4 Terminal | *Side Wireway* | Ringless | Jaw Clamping

15
320 AMP
SINGLE
POSITION
LEVER BYPASS



U2448-X



U5161-X



U1797-O-K3L-K2L

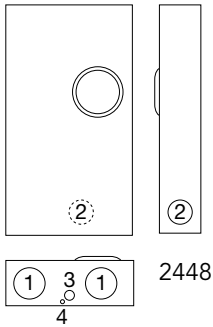

2448

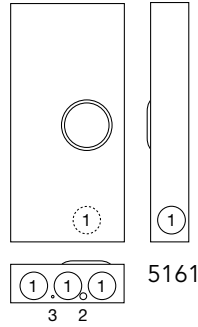

5161

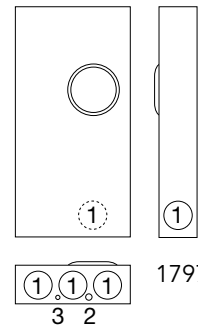

1797

320 Amp | 4 Terminal | Single Position | Lever Bypass | Side Wireway | Ringless

Catalog Number	Service	Hub	Connectors CU/AL		Bypass	Dimensions			Knockouts			
			Line	Load		D"	W"	H"	1	2	3	4
U5161-X	OH/UG	C.P.	3/8" x 16 Stud	3/8" x 16 Stud	Lever	4 7/8	15	31 1/2	3	1/4, 1/2	1/4	—
U2448-X	OH/UG	C.P.	3/8" x 16 Stud	3/8" x 16 Stud	Lever	6 1/2	17 3/4	34 1/8	4	3	1	1/4
U1797-O-K3L-K2L	UG	Blank	(1) #4-600 or (2) 1/0-250	Twin #6-350	Lever	4 7/8	15	30	3	1/4, 1/2	1/4	—

Notes

- **Hubs:** For proper hub selection see the hub suffix chart on the accessory page.
- **Bypass:** Lever supplies clamping action on meter spades and also operates bypass device.
- **Fifth Terminal:** For field-installed fifth terminal for **U2448**, **U1797** and **U5161** order catalog number **K3865**. May be installed in 6 o'clock or 9 o'clock position.

Please consult serving utility for their requirements prior to ordering or installing, as specifications and approvals vary by utility, and may require local electrical inspector approval. All installations must be installed by a licensed electrician and must comply with all national and local codes, laws and regulations. Milbank reserves the right to make changes in specifications and features shown without notice or obligation.



Single Position Lever Bypass

320 Amp | 7 Terminal | Side Wireway | Ringless | Jaw Clamping



U4911-X-BL

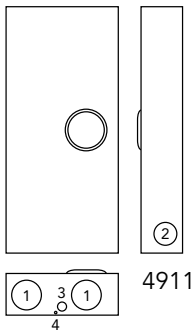

U4013-X

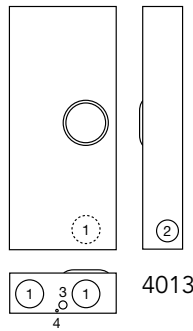

U2594-X

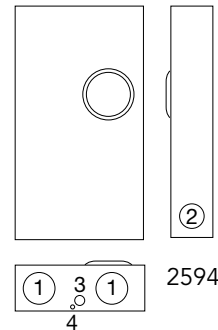

320 Amp | 7 Terminal | Single Position | Lever Bypass | Side Wireway | Ringless

Catalog Number	Service	Hub	Connectors CU/AL		Bypass	Dimensions			Knockouts			
			Line	Load		D"	W"	H"	1	2	3	4
U4911-X-BL	OH/UG	C.P.	3/8" x 16 Stud	3/8" x 16 Stud	Lever	6 1/2	17 3/4	38 3/4	4	3	1	1/4
U4013-X	OH/UG	C.P.	3/8" x 16 Stud	3/8" x 16 Stud	Lever	6 1/2	17 3/4	40 1/2	4	3	1	1/4
U2594-X	OH/UG	C.P.	3/8" x 16 Stud	3/8" x 16 Stud	Lever	6 1/2	19	34 1/8	4	3	1	1/4

Notes

- **Hubs:** For proper hub selection see the hub suffix chart on the accessory page.
- **Connectors:** Socket is supplied with 3/8" - 16 hex head nuts with Belleville washers. For connector lug kits, order as extra from chart on page 76. Separate lug kits are required for line and load.
- **Bypass:** Lever supplies clamping action on meter spades and also operates bypass device.
- **BL:** Barrel lock



Please consult serving utility for their requirements prior to ordering or installing, as specifications and approvals vary by utility, and may require local electrical inspector approval. All installations must be installed by a licensed electrician and must comply with all national and local codes, laws and regulations. Milbank reserves the right to make changes in specifications and features shown without notice or obligation.

Meter Mains

100 Amp | 4 Terminal | Ringless & Ring Type

17
100 AMP
METER MAIN



U3499-XL-100

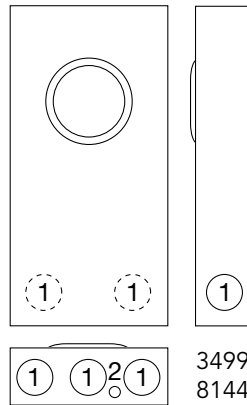

U8144-XL

100 Amp | 4 Terminal | Meter Mains | 1Ø3W | Ringless

Catalog Number	Service	Hub	Connectors CU/AL		Bypass	Dimensions			Knockouts	
			Line	Load		D"	W"	H"	1	2
U3499-XL-100	OH/UG	C.P.	#6-2/0	CB - 100A	None	3¼	11	22	2	¼, ½

Notes

- **Fifth Terminal:** For field installed fifth terminal, order catalog number **5T8K2** (9 o'clock position only).
- **Hubs:** For proper hub selection refer to the hub suffix chart on the accessory page.
- **Factory-Installed Circuit Breakers:** The **U3499-XL-100** has a factory installed 2-pole 100 amp breaker.

100 Amp | 4 Terminal | Meter Mains | 1Ø3W | Ring Type

Catalog Number	Service	Hub	Connectors CU/AL		Bypass	Dimensions			Knockouts	
			Line	Load		D"	W"	H"	1	2
U8144-RL	OH/UG	H.O.	#6-2/0	—	None	3¼	11	22	2	¼, ½

Notes

- **Hubs:** For proper hub selection refer to the hub suffix chart on the accessory page.
- **Sealing Rings:** Ring type units priced with MR-2 sealing ring. See accessory page for other choices.
- **Breakers:** The **U8144** does not come with breakers unless specified on order and requires plug-in style.

Plug-In Breaker Compatibility Chart

Amp	Cutler Hammer	Siemens	General Electric	Square D
0-100	Quicklag P BR	QP	Q Line	Homeline

Please consult serving utility for their requirements prior to ordering or installing, as specifications and approvals vary by utility, and may require local electrical inspector approval. All installations must be installed by a licensed electrician and must comply with all national and local codes, laws and regulations. Milbank reserves the right to make changes in specifications and features shown without notice or obligation.



100-200 Amp | 4 Terminal | Ringless and Ring Type

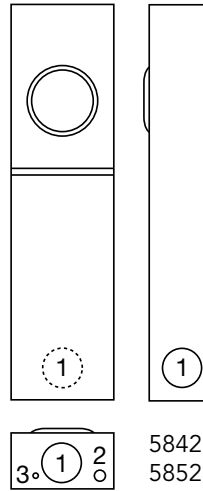

U5842-RL-KK

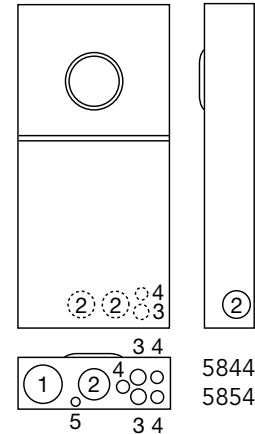

U5844-PXL-200

100-200 Amp | 4 Terminal | Meter Mains | Ringless

Catalog Number	Service	Hub	Connectors CU/AL		Bypass	Dimensions			Knockouts				
			Line	Load		D"	W"	H"	1	2	3	4	5
U5842-RL-KK*	OH	H.O.	#6-350	—	Horn	4½	8	30	2½	¼, ½	¼	—	—
U5842-RL-100*	OH	H.O.	#6-350	CB - 100A	None	4½	8	30	2½	¼, ½	¼	—	—
U5842-RL-200*	OH	H.O.	#6-350	CB - 200A	None	4½	8	30	2½	¼, ½	¼	—	—
U5844-RL*	OH/UG	H.O.	#6-350	—	None	4½	14	30	3	2½	1	½, ¾	¼, ½
U5844-PXL-100*	OH/UG	C.P.	#6-350	CB - 100A	None	4½	14	30	3	2½	1	½, ¾	¼, ½
U5844-PXL-200*	OH/UG	C.P.	#6-350	CB - 200A	None	4½	14	30	3	2½	1	½, ¾	¼, ½

100-200 Amp | 4 Terminal | Meter Mains | Ring Type

Catalog Number	Service	Hub	Connectors CU/AL		Bypass	Dimensions			Knockouts				
			Line	Load		D"	W"	H"	1	2	3	4	5
U5852-RL	OH	H.O.	#6-350	—	None	4½	8	30	2½	¼, ½	¼	—	—
U5852-RL-200	OH	H.O.	#6-350	CB - 200A	None	4½	8	30	2½	¼, ½	¼	—	—
U5854-RL	OH/UG	H.O.	#6-350	—	None	4½	14½	30	3	2½	1	½, ¾	¼, ½
U5854-PXL-200	OH/UG	C.P.	#6-350	CB - 200A	None	4½	14½	30	3	2½	1	½, ¾	¼, ½

Notes

- **AIC Rating:** All models are rated **22K AIC** when using Siemens **QPH** (100A) or **QNH** (200A) breakers.
- **Hub:** -PXL versions supplied with one (1) closing plate packed inside. Order other hubs separately.
- **Fifth Terminal:** For field installable fifth terminal kit, order **K5T**.

*Available with Horn Bypass



Please consult serving utility for their requirements prior to ordering or installing, as specifications and approvals vary by utility, and may require local electrical inspector approval. All installations must be installed by a licensed electrician and must comply with all national and local codes, laws and regulations. Milbank reserves the right to make changes in specifications and features shown without notice or obligation.

Triple Tap Meter Mains

100-200 Amp | 4 Terminal | Ringless



U9648-RL-100

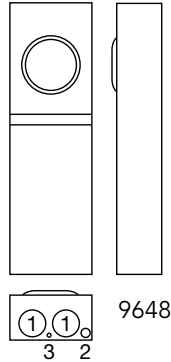

9648

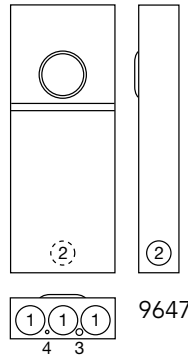

9647



U9647N-RL-200

4 Terminal | Meter Mains | Triple Tap Lugs | 1Ø3W | Ringless

Catalog Number	Amp	Service	Hub	Connectors CU/AL		Dimensions			Knockouts			
				Line	Load	D"	W"	H"	1	2	3	4
U9648-RL-100	100	OH	H.O.	#6-2/0	(3) #12-1/0	4 $\frac{1}{8}$	8	26	2	¼, ½	¼	—
U9647N-RL-200	200	OH/UG	H.O.	#6-350	(3) #6-350	4 $\frac{7}{8}$	13	33	3	2½	¼, ½	¼

Notes

- **Hubs:** For proper hub selection, refer to the hub suffix chart on the accessories page.
- **Fifth Terminal:** For field installed fifth terminal, order catalog number **5T8K2** for **U9648**. For **U9647**, order catalog number **K5T**.
- **Connectors:** Extruded aluminum connectors are tin plated with triple tap lugs on the load side.
- **Breakers:** Supplied with factory installed double pole circuit breakers of amperage shown. the **U9647** the options UQFB-A-200-X1 or 150, 125, 100

U9648 Breaker Chart

Amp	Cutler Hammer	Siemens	Murray Siemens	General Electric	Square D
51-100	Quicklag P BR	QP	MP	Q Line	Homeline
50 or less	Quicklag P BR	QP	MP	Q Line	Homeline

Please consult serving utility for their requirements prior to ordering or installing, as specifications and approvals vary by utility, and may require local electrical inspector approval. All installations must be installed by a licensed electrician and must comply with all national and local codes, laws and regulations. Milbank reserves the right to make changes in specifications and features shown without notice or obligation.



Meter Main With Load Center

100-200 Amp | 4 Terminal | Ringless

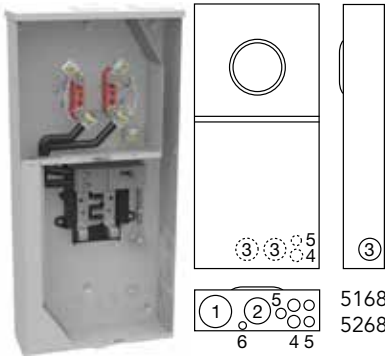

U5168-XTL-200



U5268-XTL-200-KK

Generator Interlock

	K5815 Large QN with small frame Q	K5820 Large frame QN with large frame QN	K5830 Small frame Q to small frame Q
--	---	--	--

100-200 Amp | 4 Terminal | Meter Mains | OH/UG | 1Ø3W | Ringless

Catalog Number	Circuits	Bypass	Hub	Connectors CU/AL	Dimensions			Knockouts					
				Line	D"	W"	H"	1	2	3	4	5	6
U5168-XTL-100	10	None	C.P.	#6-350	4½	14⅞	32	3	2½	2	1	½,¾	¼,½
U5168-XTL-100-KK	10	Horn	C.P.	#6-350	4½	14⅞	32	3	2½	2	1	½,¾	¼,½
U5168-XTL-100-KK-5T	10	Horn	C.P.	#6-350	4½	14⅞	32	3	2½	2	1	½,¾	¼,½
U5168-XTL-150	8	None	C.P.	#6-350	4½	14⅞	32	3	2½	2	1	½,¾	¼,½
U5168-XTL-150-KK	8	Horn	C.P.	#6-350	4½	14⅞	32	3	2½	2	1	½,¾	¼,½
U5168-XTL-150-KK-5T	8	Horn	C.P.	#6-350	4½	14⅞	32	3	2½	2	1	½,¾	¼,½
U5168-XTL-200	8	None	C.P.	#6-350	4½	14⅞	32	3	2½	2	1	½,¾	¼,½
U5168-XTL-200-KK	8	Horn	C.P.	#6-350	4½	14⅞	32	3	2½	2	1	½,¾	¼,½
U5168-XTL-200-KK-5T	8	Horn	C.P.	#6-350	4½	14⅞	32	3	2½	2	1	½,¾	¼,½
U5268-XTL-150	20	None	C.P.	#6-350	4½	14⅞	32	3	2½	2	1	½,¾	¼,½
U5268-XTL-150-KK	20	Horn	C.P.	#6-350	4½	14⅞	32	3	2½	2	1	½,¾	¼,½
U5268-XTL-200	20	None	C.P.	#6-350	4½	14⅞	32	3	2½	2	1	½,¾	¼,½
U5268-XTL-200-KK	20	Horn	C.P.	#6-350	4½	14⅞	32	3	2½	2	1	½,¾	¼,½

Notes

- **Hubs:** Supplied with two closing plates packed inside. Order hubs as a separate item. For proper hub selection, refer to the hub suffix chart on the accessories page.
- **Fifth Terminal:** For field installed fifth terminal, order **K5T**.
- **Breakers:** Rated 22K AIC with Milbank **QNR2200RH** main installed.
- **Main Breaker:** **U5168** available with 100-150 amp breakers, consult factory.
- **Sub Feed Lugs:** #6-350 sub feed lugs provided on 10 circuit interior. **Not available on 20 circuit interior.**
- **Horn Bypass:** **U5168, U5268** units are available with horn bypass, add -KK suffix.

Branch Breaker Chart

AIC Rating	Amps	Siemens	Cutler Hammer	General Electric	Square D
10k	150-200	QNR	BR (150A only)	—	—
	≤ 125	QP	HQP, BR	THQL, THQL-GF	Homeline
22k	150-200	QNRH	—	—	—
	≤ 125	QPH	—	—	—



Please consult serving utility for their requirements prior to ordering or installing, as specifications and approvals vary by utility, and may require local electrical inspector approval. All installations must be installed by a licensed electrician and must comply with all national and local codes, laws and regulations. Milbank reserves the right to make changes in specifications and features shown without notice or obligation.

Meter Main With Load Center

100-200 Amp | 4 Terminal | Ring Type

21

100-200 AMP
METER MAINS
WITH LOAD
CENTER



U5169-XTL-100

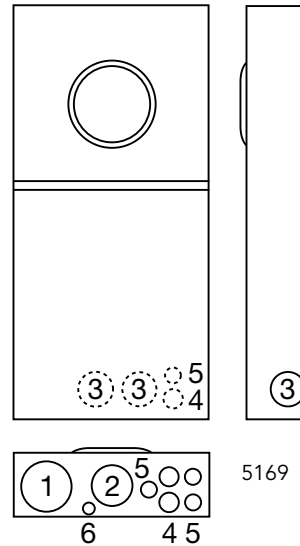

100-200 Amp | 4 Terminal | Meter Mains | 1Ø3W | Ring Type

Catalog Number	Circuits	Service	Hub	Connectors CU/AL	Dimensions			Knockouts					
				Line	D"	W"	H"	1	2	3	4	5	6
U5169-XTL-100	10	OH/UG	C.P.	#6-350	4½	14⅛	32	3	2½	2	1	½,¾	¼,½
U5169-XTL-200	8	OH/UG	C.P.	#6-350	4½	14⅛	32	3	2½	2	1	½,¾	¼,½
U5269-XTL-200	20	OH/UG	C.P.	#6-350	4½	14⅛	32	3	2½	2	1	½,¾	¼,½

Generator Interlock

	K5815 Large QN with small frame Q	K5820 Large frame QN with large frame QN	K5830 Small frame Q to small frame Q
---	---	--	--

Branch Breaker Chart

AIC Rating	Amps	Siemens	Cutler Hammer	General Electric	Square D
10k	150-200	QNR	BR (150A only)	—	—
	≤ 125	QP	HQP, BR	THQL, THQL-GF	Homeline
22k	150-200	QNRH	—	—	—
	≤ 125	QPH	—	—	—

Please consult serving utility for their requirements prior to ordering or installing, as specifications and approvals vary by utility, and may require local electrical inspector approval. All installations must be installed by a licensed electrician and must comply with all national and local codes, laws and regulations. Milbank reserves the right to make changes in specifications and features shown without notice or obligation.



Meter Main With Load Center

200 Amp | 4 Terminal | Ringless



U5818-RL-200S

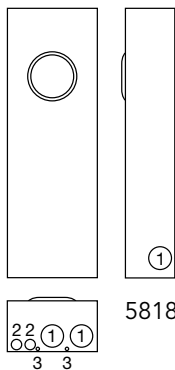

U5898-O-200

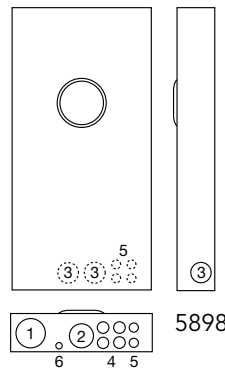

UAP5024-XL

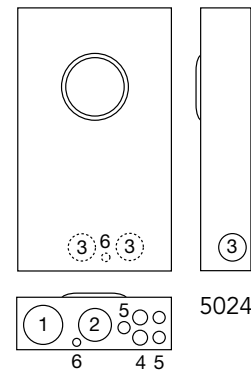

4 Terminal | Meter Main / Meter Load Center | 1Ø3W | Ringless

Catalog Number	Amp	Service	Hub	Connectors CU/AL Line	Branch Circuits	Dimensions			Knockouts					
						D"	W"	H"	1	2	3	4	5	6
U5818-RL-200S	200	OH	H.O.	#6-350	4	5½	10	30	2	½,¾	¼	—	—	—
U5898-O-200	200	UG	Blank	#6-350	8	4½	17	34½	3	2½	2	1	½,¾	¼,½
UAP5024-XL*	200	OH/UG	C.P.	#6-350	12	4½	14⅞	24	3	2½	2	1	½,¾	¼,½

Notes

- **Hubs:** For proper hub selection, refer to the hub suffix chart on the accessories page.
- **Receptacles:** Consult factory for factory-installed receptacle assemblies for the **U5818**.
- **Fifth Terminal Kit:** For field installed fifth terminal, order **K5T**.
- **Horn Bypass:** Available on **U5898** and **U5818**, add suffix **-KK**.
- **Interlock Kit:** For **U5898** generator auxiliary circuit breaker interlock, order **K5815** for large **QN** with small frame **Q**; order **K5820** for large frame **QN** with large frame **QN**; order **K5830** for small frame **Q** to small frame **Q**.

*Aluminum Enclosure on **UAP5024-XL**, Main breakers sold separately.



Please consult serving utility for their requirements prior to ordering or installing, as specifications and approvals vary by utility, and may require local electrical inspector approval. All installations must be installed by a licensed electrician and must comply with all national and local codes, laws and regulations. Milbank reserves the right to make changes in specifications and features shown without notice or obligation.

Meter Mains

200 Amp | 4 & 7 Terminal | Lever Bypass | Ringless

23
200 AMP
METER MAINS



U5880-RXL-200-BL



U5871-XL-200

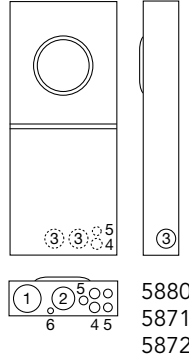

U5750-RXL-200-BL

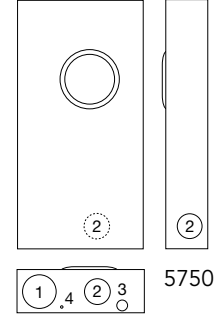

200 Amp | 4 Terminal | Meter Mains | Lever Bypass | Ringless

Catalog Number	Service	Hub	Connectors	Branch Circuits	Dimensions			Knockouts					
			CU/AL Line		D"	W"	H"	1	2	3	4	5	6
U5880-RXL-200-BL	OH/UG	C.P.	#6-350	—	4½	14⅞	33½	3	2½	2	1	½,¾	¼,½
U5871-XL-200	OH/UG	C.P.	#6-350	8	4½	14⅞	32	3	2½	2	1	½,¾	¼,½
U5872-XL-200	OH/UG	C.P.	#6-350	20	4½	14⅞	32	3	2½	2	1	½,¾	¼,½

200 Amp | 7 Terminal | Meter Mains | Lever Bypass | Ringless

Catalog Number	Service	Hub	Connectors	Branch Circuits	Dimensions			Knockouts					
			CU/AL Line		D"	W"	H"	1	2	3	4	5	6
U5750-RXL-200-BL	OH/UG	C.P.	#6-350	—	5¾	17⅞	34	4	3	1	¼	—	—

Notes

- **Breakers:** Rated 22K AIC with Milbank **QNR2200RH** main installed.
- **Fifth Terminal:** For field installed fifth terminal, order **K3865**.
- **Interlock Kit:** For generator auxiliary circuit breaker interlock for **U5871** and **U5872**, order **K5815** for large **QN** with small frame **Q**; order **K5820** for large frame **QN** with large frame **QN**.
- **Sub Feed Lugs:** #6-350 sub feed lugs provided on 8 circuit interior. **Not available on 20 circuit interior.**
- **-BL:** Barrel lock

Please consult serving utility for their requirements prior to ordering or installing, as specifications and approvals vary by utility, and may require local electrical inspector approval. All installations must be installed by a licensed electrician and must comply with all national and local codes, laws and regulations. Milbank reserves the right to make changes in specifications and features shown without notice or obligation.



Lever Bypass Meter Mains w/ 2/200A Breakers

320 Amp | 4 & 7 Terminal | Ringless | Jaw Clamping



U5059-X-2/200

U5890-X-2/200

U5894-X-2/200

U6115-X-2/200-K7L

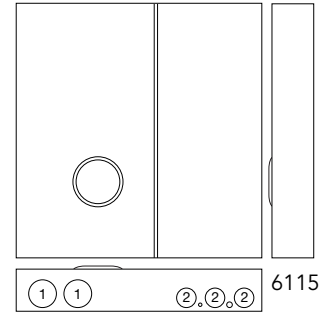
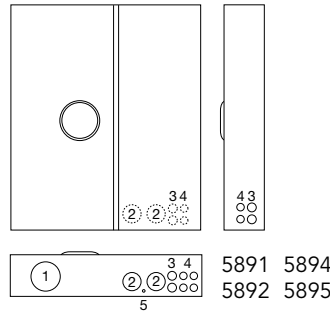
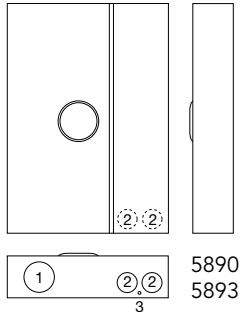
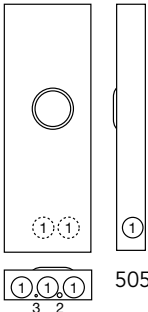

320 Amp | 4 Terminal | Meter Mains | Lever Bypass | Ringless

Catalog Number	Service	Hub	Connectors CU/AL	Branch Circuits	Dimensions			Knockouts				
			Line		D"	W"	H"	1	2	3	4	5
U5059-X-2/200-K3L	OH/UG	C.P.	#6-350	N/A	4 ⁷ / ₈	15	42	3	1/4, 1/2	1/4	—	—
U5890-X-2/200	OH/UG	C.P.	#6-350	N/A	6	24 ¹ / ₂	35	4	2 ¹ / ₂	1/4	—	—
U5891-X-2/200*	OH/UG	C.P.	#6-350	12	6	29 ¹ / ₂	35	4	2 ¹ / ₂	1	1/2, 3/4	1/4
U5892-X-2/200	OH/UG	C.P.	#6-350	24	6	29 ¹ / ₂	35	4	2 ¹ / ₂	1	1/2, 3/4	1/4
U5893-X-2/200	OH/UG	C.P.	#6-350	N/A	6	24 ¹ / ₂	35	4	2 ¹ / ₂	1/4	—	—
U5894-X-2/200*	OH/UG	C.P.	#6-350	12	6	29 ¹ / ₂	35	4	2 ¹ / ₂	1	1/2, 3/4	1/4
U5895-X-2/200	OH/UG	C.P.	#6-350	24	6	29 ¹ / ₂	35	4	2 ¹ / ₂	1	1/2, 3/4	1/4

320 Amp | 7 Terminal | Meter Mains | Lever Bypass | Ringless

Catalog Number	Service	Hub	Connectors CU/AL	Dimensions			Knockouts			
			Line	D"	W"	H"	1	2	3	4
U6115-X-2/200-K7L	OH/UG	C.P.	(2) 1/0 - 250 or 4-600kcmil	7	34 ¹ / ₄	34	1/2, 3/4	1/2, 3/4	1/2, 3/4	1/2, 3/4

Notes

- **Short Circuit Current Rating:** 22K AIC at 120/240 Volts or 10K at 480 Volts.
- **Breakers:** All units come with two 200A main breakers.
- **Side Bussed Units:** U5893, U5894 and U5895.
- *Main Lug feed-through kit: K3701- for factory installed order part number with -MLK.
- **Fifth Terminal:** For field mounted fifth terminal order catalog number K3865.



Please consult serving utility for their requirements prior to ordering or installing, as specifications and approvals vary by utility, and may require local electrical inspector approval. All installations must be installed by a licensed electrician and must comply with all national and local codes, laws and regulations. Milbank reserves the right to make changes in specifications and features shown without notice or obligation.

Lever Bypass Meter Mains w/ 400A Breaker

320 Amp | 4 & 7 Terminal | Ringless | Jaw Clamping

25
320 AMP
LEVER BYPASS
METER MAIN

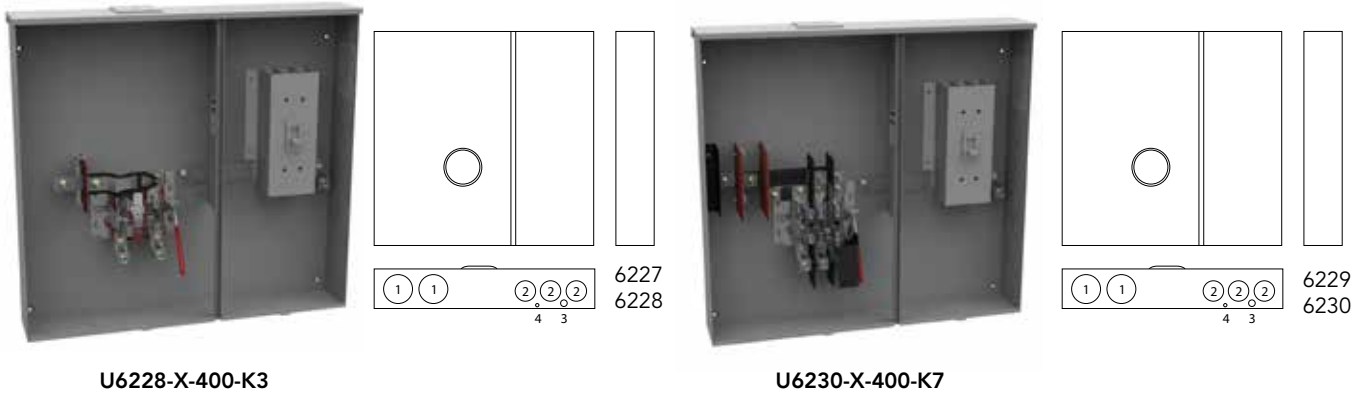

320 Amp | 4 Terminal | Meter Mains | Lever Bypass | Ringless

Catalog Number	Service	Hub	Connectors CU/AL	Dimensions			Knockouts			
			Line	D"	W"	H"	1	2	3	4
U6227-X-400-K3	OH/UG	C.P.	600 kcmil	6	36¼	34	4	2½	½	¼
U6228-X-400-K3*	OH/UG	C.P.	600 kcmil	6	36¼	34	4	2½	½	¼

320 Amp | 7 Terminal | Meter Mains | Lever Bypass | Ringless

Catalog Number	Service	Hub	Connectors CU/AL	Dimensions			Knockouts			
			Line	D"	W"	H"	1	2	3	4
U6229-X-400-K7	OH/UG	C.P.	600 kcmil	6	36¼	34	4	2½	½	¼
U6230-X-400-K7*	OH/UG	C.P.	600 kcmil	6	36¼	34	4	2½	½	¼

Notes

- **Short Circuit Current Rating: 22K AIC** at 120/240 Volts or 10K at 480 Volts
- ***Side Bussing:** U6228 and U6230 have side bussing.

Please consult serving utility for their requirements prior to ordering or installing, as specifications and approvals vary by utility, and may require local electrical inspector approval. All installations must be installed by a licensed electrician and must comply with all national and local codes, laws and regulations. Milbank reserves the right to make changes in specifications and features shown without notice or obligation.



Cold Sequence Meter Mains

4, 5 & 7 Terminal | Ringless



U5767-X-200-CB



U5787-O-200-CB

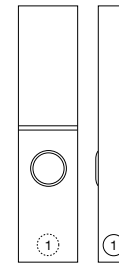

5794
5796

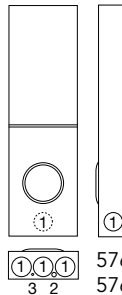

5764 5767
5765

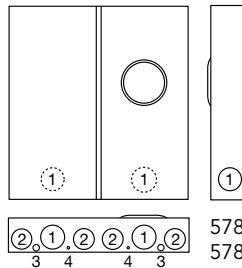

5784
5787

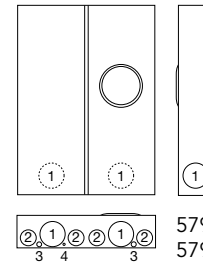

5797
5799

200 Amp Circuit Breaker Disconnect Ahead Of Meter Socket

Catalog Number	Terminals	Service	Hub	Connectors	Bypass	Dimensions			Knockouts			
				CU/AL		D"	W"	H"	1	2	3	4
U5764-X-200-CB	4	OH/UG	C.P.	#6-350	Lever	4 ²⁷ / ₃₂	13	43	4	2½	¼	—
U5784-O-200-CB	4	UG	Blank	#6-350	Lever	4 ²⁷ / ₃₂	26	28	4	2½	¼	—
U5765-X-200-CB	5	OH/UG	C.P.	#6-350	Lever	4 ²⁷ / ₃₂	13	43	4	2½	1	½, ¾
U5767-X-200-CB	7	OH/UG	C.P.	#6-350	Lever	4 ²⁷ / ₃₂	13	43	4	2½	1	½, ¾
U5787-O-200-CB	7	UG	Blank	#6-350	Lever	6	26	28	4	2½	1	½, ¾

400 Amp (320 Amp Continuous) Circuit Breaker Disconnect Ahead Of Meter Socket

Catalog Number	Terminals	Service	Hub	Connectors	Bypass	Dimensions			Knockouts			
				CU/AL		D"	W"	H"	1	2	3	4
U5794-X-400-CB	4	OH	C.P.	(1) #4-600kcmil (2) 1/0-250kcmil	Lever	6	13	56	4	2½	½, ¾	¾
U5797-O-400-CB	4	UG	Blank	(1) #4-600kcmil (2) 1/0-250kcmil	Lever	6	26	36	4	2½	1	½, ¾
U5796-X-400-CB	7	OH	C.P.	(1) #4-600kcmil (2) 1/0-250kcmil	Lever	6	13	56	4	2½	¼	—
U5799-O-400-CB	7	UG	Blank	(1) #4-600kcmil (2) 1/0-250kcmil	Lever	6	26	36	4	2½	1	½, ¾

Notes

- **Hubs:** For proper hub selection, refer to the hub suffix chart on the accessories page.



Please consult serving utility for their requirements prior to ordering or installing, as specifications and approvals vary by utility, and may require local electrical inspector approval. All installations must be installed by a licensed electrician and must comply with all national and local codes, laws and regulations. Milbank reserves the right to make changes in specifications and features shown without notice or obligation.

Multi-Position Sockets

100 Amp | 4 Terminal | Ringless | 300 VAC

27
100 AMP
MULTI-
POSITION



U8212-RL

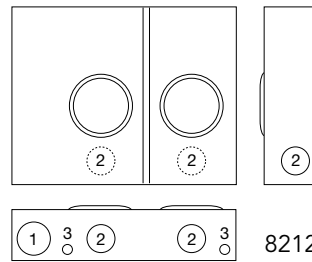

8212

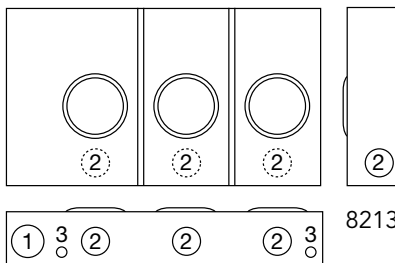

8213

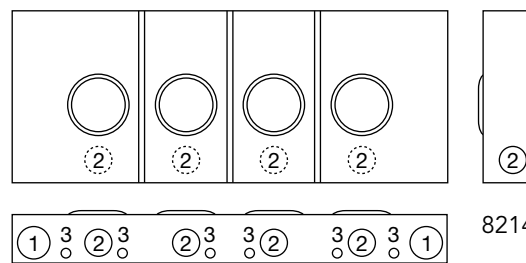

8214

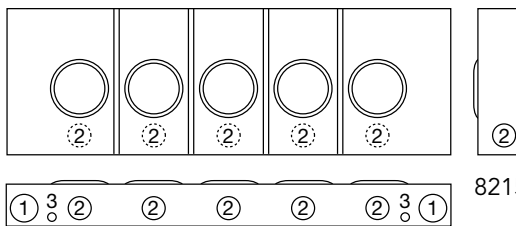

8215

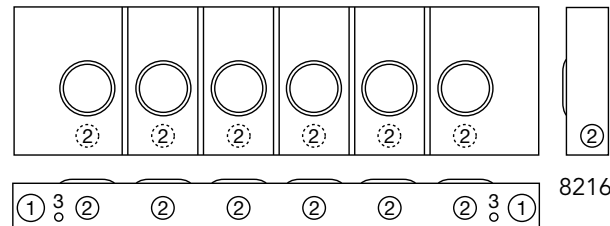

8216

100 Amp per Position | 4 Terminal | Multi-Position | Ringless

Catalog Number	Positions	Service	Hub	Connectors CU/AL		Dimensions			Knockouts		
				Line	Load	D"	W"	H"	1	2	3
U8212-RL	2	OH/UG	H.O.	#6-350	#6-2/0	4½	20⅝	16	2½	2	¼,½
U8213-RL	3	OH/UG	H.O.	#6-350	#6-2/0	4½	28½	16	2½	2	¼,½
U8214-RL	4	OH/UG	H.O.	#6-350	#6-2/0	4½	40⅞	16	2½	2	¼,½
U8215-RL	5	OH/UG	H.O.	#6-350	#6-2/0	4½	48⅞	16	2½	2	¼,½
U8216-XL	6	OH/UG	C.P.	#6-350	#6-2/0	4½	57⅞	16	2½	2	¼,½

Notes

- **Hub:** For proper hub selection refer to the hub suffix chart on the accessory page. A hub opening is supplied at each end and the extra opening is closed with a closing plate as standard.
- **Fifth Terminal Kit:** For field mounted fifth terminal, order **5T8K2** (6 o'clock position).
- **Connectors:** Extruded aluminum connectors are tin plated.

Please consult serving utility for their requirements prior to ordering or installing, as specifications and approvals vary by utility, and may require local electrical inspector approval. All installations must be installed by a licensed electrician and must comply with all national and local codes, laws and regulations. Milbank reserves the right to make changes in specifications and features shown without notice or obligation.



Multi-Position Sockets

200 Amp | 4 Terminal | Ringless | 300 VAC



U1254-X

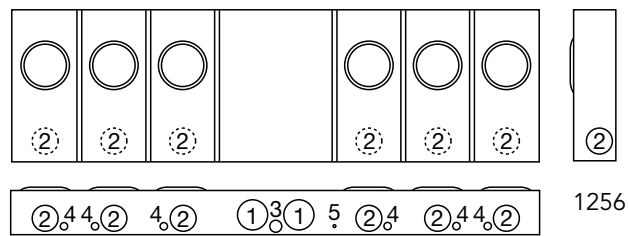
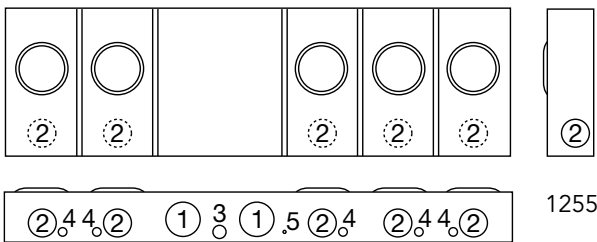
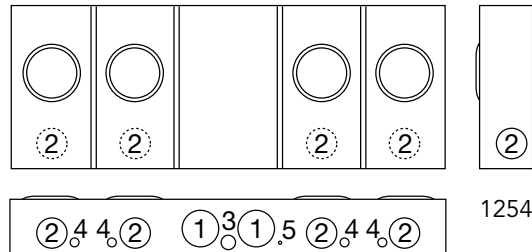
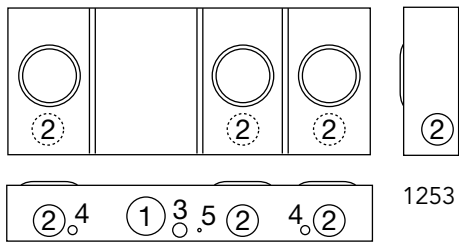
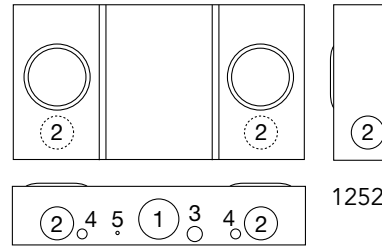

200 Amp per Position | 4 Terminal | Multi-Position | Ringless

Catalog Number	Positions	Service	Hub	Connectors CU/AL		Dimensions			Knockouts				
				Line	Load	D"	W"	H"	1	2	3	4	5
U1252-X	2	OH/UG	C.P.	3/8" x 16 Stud	#6-350	5 1/8	26 1/2	14	3	2 1/2	1	1/2	1/4
U1253-X	3	OH/UG	C.P.	3/8" x 16 Stud	#6-350	5 1/8	34 3/4	14	3	2 1/2	1	1/2	1/4
U1254-X	4	OH/UG	C.P.	3/8" x 16 Stud	#6-350	5 1/8	42 7/8	16	3	2 1/2	1	1/2	1/4
U1255-X	5	OH/UG	C.P.	3/8" x 16 Stud	#6-350	5 1/8	54 1/2	16	3	2 1/2	1	1/2	1/4
U1256-X	6	OH/UG	C.P.	3/8" x 16 Stud	#6-350	5 1/8	63 1/16	18	3	2 1/2	1	1/2	1/4

Notes

- **Hubs:** For proper hub selection, refer to the hub suffix chart on the accessories page. For the **U1254-6** two hub openings are supplied and the extra opening is closed with a closing plate as standard.
- **Fifth Terminal:** For field mounted fifth terminal, order catalog number **K5T** (9 o'clock position).
- **Connectors:** Extruded aluminum connectors are tin plated. For line side connector lug kits, order as extra from chart on page 76.



Please consult serving utility for their requirements prior to ordering or installing, as specifications and approvals vary by utility, and may require local electrical inspector approval. All installations must be installed by a licensed electrician and must comply with all national and local codes, laws and regulations. Milbank reserves the right to make changes in specifications and features shown without notice or obligation.

Lever Bypass Multi-Position Sockets

200 Amp | 5 Terminal | Ringless | 300 VAC | Jaw Clamping

29
200 AMP
LEVER BYPASS
MULTI-POSITION

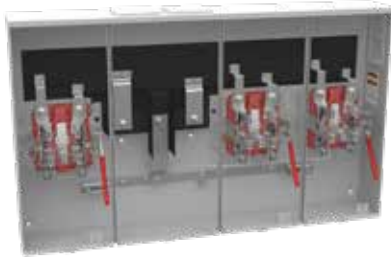

U2873-XT

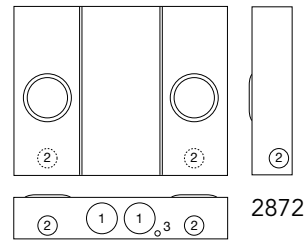

2872

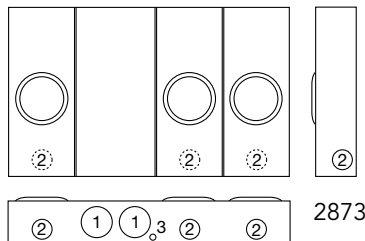

2873

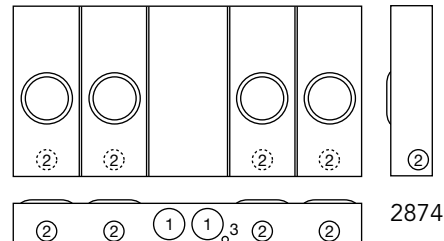

2874

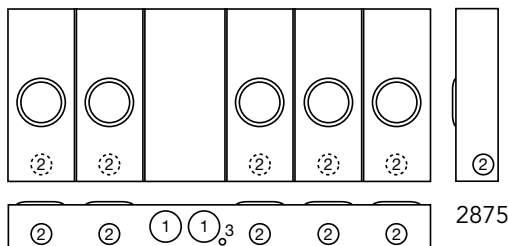

2875

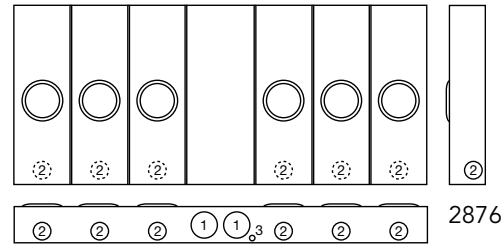

2876

200 Amp per Position | 5 Terminal | Lever Bypass | Multi-Position | Ringless

Catalog Number	Positions	Service	Hub	Connectors CU/AL		Dimensions			Knockouts		
				Line	Load	D"	W"	H"	1	2	3
U2872-XT	2	OH/UG	(2) C.P.	3/8" x 16 Stud	#6-350	6	32 1/8	25 1/4	4	2 1/2	1/4, 1/2
U2873-XT	3	OH/UG	(2) C.P.	3/8" x 16 Stud	#6-350	6	42 3/16	25 1/4	4	2 1/2	1/4, 1/2
U2874-XT	4	OH/UG	(2) C.P.	3/8" x 16 Stud	#6-350	6	52 1/4	25 1/4	4	2 1/2	1/4, 1/2
U2875-XT	5	OH/UG	(2) C.P.	3/8" x 16 Stud	#6-350	6	62 5/16	25 1/4	4	2 1/2	1/4, 1/2
U2876-XT	6	OH/UG	(2) C.P.	3/8" x 16 Stud	#6-350	6	72 3/8	31 1/4	4	2 1/2	1/4, 1/2

Notes

- **Hubs:** Units supplied with two closing plates. To order hubs as extra, refer to the hub suffix chart on the accessories page.
- **Connector Kits:** For line side connector kits, order as extra **K1539** (350 kcmil), **K1540** (600 kcmil), twin **K1350** (350 kcmil), twin **K1541** (600 kcmil). Line connectors can be reversed to change from "OH" to "UG" service. For line side connector lug kits, order as extra from chart on 76
- **Bypass:** Lever supplies clamping action on meter spades and also operates bypass device.

Please consult serving utility for their requirements prior to ordering or installing, as specifications and approvals vary by utility, and may require local electrical inspector approval. All installations must be installed by a licensed electrician and must comply with all national and local codes, laws and regulations. Milbank reserves the right to make changes in specifications and features shown without notice or obligation.



30
200 AMP
MULTI-
POSITION

Lever Bypass Multi-Position Sockets

200 Amp | 7 Terminal | Ringless | 300 VAC | Jaw Clamping



U2732-XT

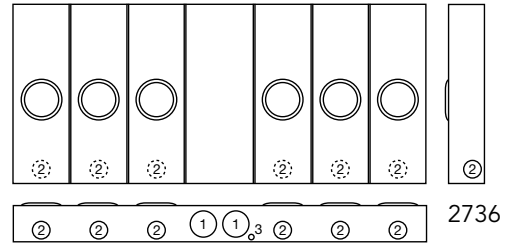
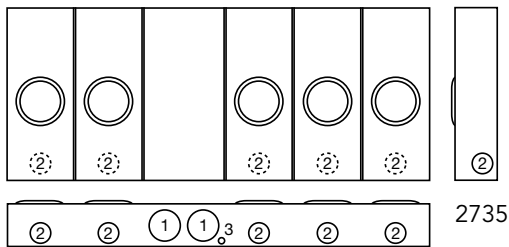
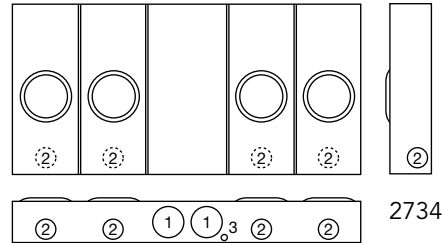
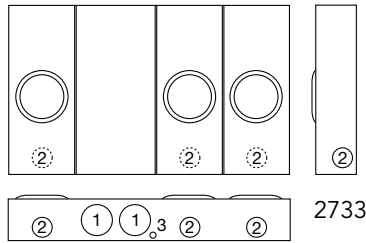
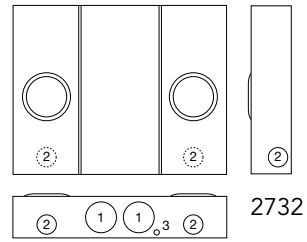

200 Amp per Position | 7 Terminal | Multi-Position | Lever Bypass | Ringless

Catalog Number	Positions	Service	Hub	Connectors CU/AL		Dimensions			Knockouts		
				Line	Load	D"	W"	H"	1	2	3
U2732-XT	2	OH/UG	(2) C.P.	3/8" x 16 Stud	#6-350	6	32 1/8	25 1/4	4	2 1/2	1/4, 1/2
U2733-XT	3	OH/UG	(2) C.P.	3/8" x 16 Stud	#6-350	6	42 3/16	25 1/4	4	2 1/2	1/4, 1/2
U2734-XT	4	OH/UG	(2) C.P.	3/8" x 16 Stud	#6-350	6	52 1/4	25 1/4	4	2 1/2	1/4, 1/2
U2735-XT	5	OH/UG	(2) C.P.	3/8" x 16 Stud	#6-350	6	62 5/16	25 1/4	4	2 1/2	1/4, 1/2
U2736-XT	6	OH/UG	(2) C.P.	3/8" x 16 Stud	#6-350	6	72 3/8	31 1/4	4	2 1/2	1/4, 1/2

Notes

- **Hubs:** Units supplied with two closing plates. To order hubs as extra, refer to the hub suffix chart on the accessories page.
- **Connector Kits:** For line side connector kits, order as extra **K3082** (350 kcmil), **K3441** (600 kcmil), twin **K3442** (350 kcmil), twin **K3083** (600 kcmil). Line connectors can be reversed to change from "OH" to "UG" service.
- **Bypass:** Lever supplies clamping action on meter spades and also operates bypass device.



Please consult serving utility for their requirements prior to ordering or installing, as specifications and approvals vary by utility, and may require local electrical inspector approval. All installations must be installed by a licensed electrician and must comply with all national and local codes, laws and regulations. Milbank reserves the right to make changes in specifications and features shown without notice or obligation.

Multi-Position Meter-Main Sockets

125 & 200 Amp | 4 Terminal | Ringless | 120/240 VAC

31
125-200 AMP
MULTI-
POSITION
METER MAIN



U2854-X



U2866-X

125 Amp per Position | Multi-Position Sockets | Ringless

Catalog Number	Amp Per Position	Positions	Main Bus Rating	Line Connector Size	Dimensions		
					D"	W"	H"
U2852-X	125	2	200 Amp	3/8" x 16 Stud*	5 13/16	18	25
U2853-X	125	3	200 Amp	3/8" x 16 Stud*	5 13/16	18	37
U2854-X	125	4	400 Amp	3/8" x 16 Stud*	4 7/8	31	25
U2855-X	125	5	400 Amp	3/8" x 16 Stud*	4 7/8	31	37
U2856-X	125	6	400 Amp	3/8" x 16 Stud*	4 7/8	31	37

200 Amp per Position | Multi-Position Sockets | Ringless

Catalog Number	Amp Per Position	Positions	Main Bus Rating	Line Connector Size	Dimensions		
					D"	W"	H"
U2862-X	200	2	250 Amp	3/8" x 16 Stud*	5 13/16	21	29
U2863-X	200	3	300 Amp	3/8" x 16 Stud*	5 13/16	21	41
U2864-X	200	4	400 Amp	3/8" x 16 Stud*	4 7/8	36	29
U2865-X	200	5	600 Amp	3/8" x 16 Stud*	4 7/8	36	41
U2866-X	200	6	600 Amp	3/8" x 16 Stud*	4 7/8	36	41

Connector Kits*

Size	Suffix	Kit Number	Compatible With	Wire Range
Single	-K1	K1539	U2852-56, U2862-66	#6-350
	-K3	K1540	U2854-56, U2864-66	#4-600
Twin	-K2	K1350	U2854-56, U2863-66	#6-350
	-K4	K1541	U2864-66	#2-600

Breaker Chart

Manufacturer	125-200 Amp	125 Amp or Less
Cutler Hammer	BR, BJ	Quicklag P, BR, HQP
Siemens	QNR	QP
Siemens/Murray	MD	MP
G.E.	Q Line	Q Line
Square D	—	Homeline

Notes

- **Connectors:** For line wire connector kits, order separately.
- **Fifth Terminal:** For field mounted fifth terminal, order catalog number **K2381**. Order one per meter position.
- **Breakers:** Units have provision for one double pole main per meter position. Breakers not included.
- **Short Circuit Current Rating:** 10K AIC. However, this rating is limited to the lowest interrupting capacity of any circuit breaker installed. Watthour meter not included in short circuit current rating.
- **Knockouts:** See next page for drawings and knockout configurations.
- **Horn Bypass :** Available, add -KK suffix

Please consult serving utility for their requirements prior to ordering or installing, as specifications and approvals vary by utility, and may require local electrical inspector approval. All installations must be installed by a licensed electrician and must comply with all national and local codes, laws and regulations. Milbank reserves the right to make changes in specifications and features shown without notice or obligation.



Multi-Position Meter-Main Sockets

Knockout Information

Catalog Number	Knockouts		
	1	2	3
U2852-X	3	1¼	¼,½
U2853-X	3	1¼	¼,½
U2854-X	3	1¼	¼,½
U2855-X	3	1¼	¼,½
U2856-X	3	1¼	¼,½
U2862-X	3	2	¼,½
U2863-X	3	2	¼,½
U2864-X	3	2	¼,½
U2865-X	3	2	¼,½
U2866-X	3	2	¼,½

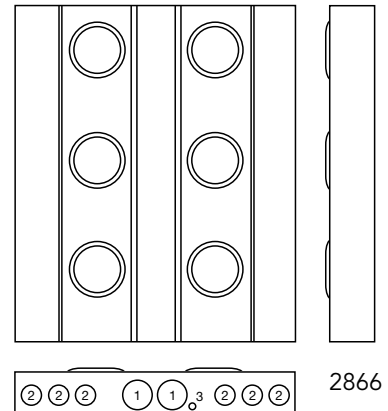
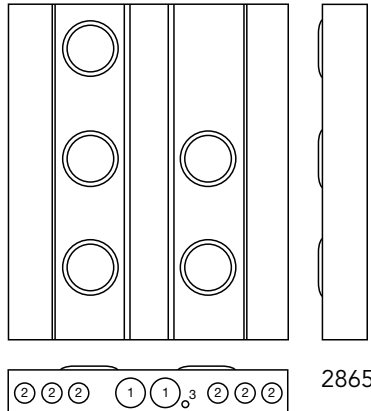
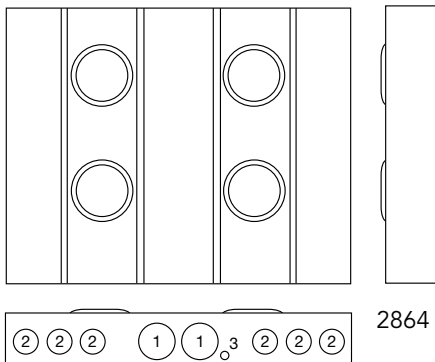
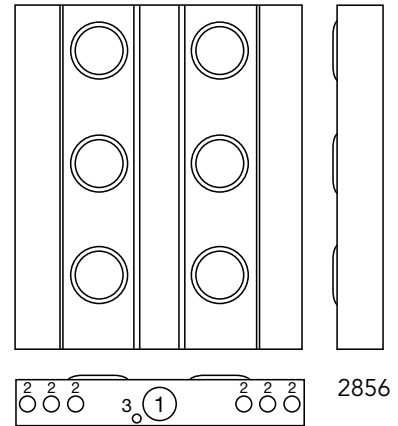
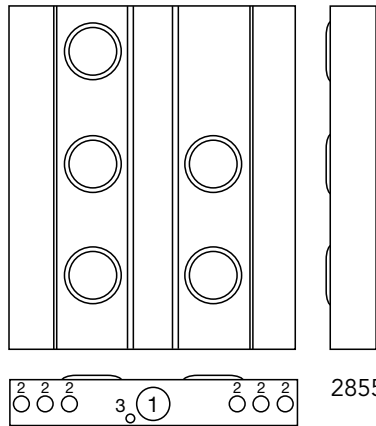
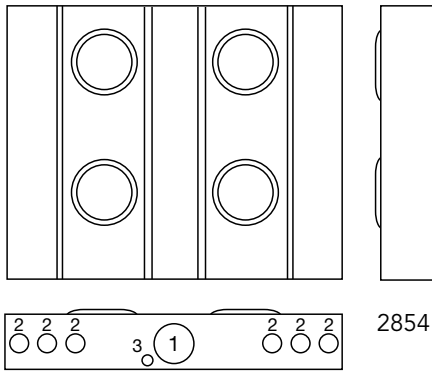
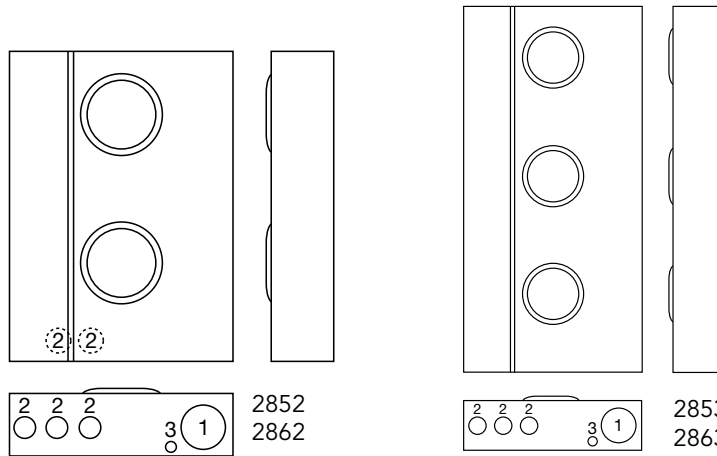

Please consult serving utility for their requirements prior to ordering or installing, as specifications and approvals vary by utility, and may require local electrical inspector approval. All installations must be installed by a licensed electrician and must comply with all national and local codes, laws and regulations. Milbank reserves the right to make changes in specifications and features shown without notice or obligation.

Multi-Position Meter Mains

125-200 Amp | 4 Terminal | Ringless | 22K AIC Rated
120/240 VAC

33
125-200 AMP
MULTI-
POSITION
METER MAINS



U5882-X



U5884-X

125 Amp per Position | 4 Terminal | Multi-Position Meter Main | Ringless

Catalog Number	Amp	Positions	Service	Hub	Connectors CU/AL	Dimensions			Weight (lbs.)
					Line	D"	W"	H"	
U5902-X	125	2	OH/UG	C.P.	3/8" x 16 Stud	5 1/8"	26 1/2"	30"	58
U5903-X	125	3	OH/UG	C.P.	3/8" x 16 Stud	5 1/8"	34 5/8"	30"	88
U5904-X	125	4	OH/UG	C.P.	3/8" x 16 Stud	5 1/8"	42 5/8"	30"	107
U5905-X	125	5	OH/UG	C.P.	3/8" x 16 Stud	5 1/8"	51 1/20"	30"	128
U5906-X	125	6	OH/UG	C.P.	3/8" x 16 Stud	5 1/8"	59 7/10"	30"	146

200 Amp per Position | 4 Terminal | Multi-Position Meter Main | Ringless

Catalog Number	Amp	Positions	Service	Hub	Connectors CU/AL	Dimensions			Weight (lbs.)
					Line	D"	W"	H"	
U5882-X	200	2	OH/UG	C.P.	3/8" x 16 Stud	5 1/8"	26 1/2"	30"	58
U5883-X	200	3	OH/UG	C.P.	3/8" x 16 Stud	5 1/8"	34 5/8"	30"	88
U5884-X	200	4	OH/UG	C.P.	3/8" x 16 Stud	5 1/8"	42 5/8"	30"	107
U5885-X	200	5	OH/UG	C.P.	3/8" x 16 Stud	5 1/8"	51 1/20"	30"	128
U5886-X	200	6	OH/UG	C.P.	3/8" x 16 Stud	5 1/8"	59 7/10"	30"	146

Breaker Chart - 10K AIC (unless noted 22K)

Manufacturer	Cutler Hammer	Siemens	G.E. (50 Amp Max)	Square D
125 Amp or Less	BR, HQP, QPGF	QP, QPH (22K)	THQL, THQL-GF	Homeline
150-200 Amp	BR, BJ	QN, QNH (22K)	—	—

Notes

- **Knockouts:** See drawings on the next page.
- **Optional:** Factory installed breakers are available - consult factory.
- **AIC Rating:** All models are rated 22K AIC.
- **Hub:** Units supplied with one (1) closing plate. Order hubs separately, see accessory page.
- **Fifth Terminal:** For field installed fifth terminal, order K5T.
- **Connectors:** Socket is supplied with 3/8" - 16 hex head nuts with Belleville washers. For connector lug kits, order as extra from chart on page 76.
- **Horn Bypass :** Available, add -KK suffix

Please consult serving utility for their requirements prior to ordering or installing, as specifications and approvals vary by utility, and may require local electrical inspector approval. All installations must be installed by a licensed electrician and must comply with all national and local codes, laws and regulations. Milbank reserves the right to make changes in specifications and features shown without notice or obligation.



Multi-Position Meter Mains

U5902 & U5882 Series Knockout information

Knockouts				
1	2	3	4	5
3	2½	1	7/8	¼

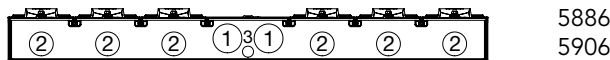
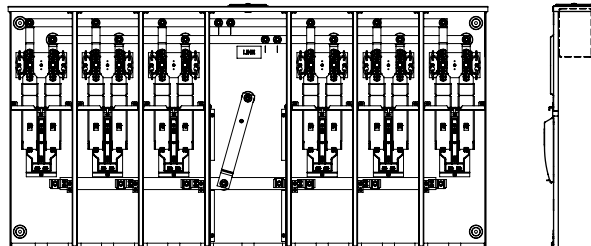
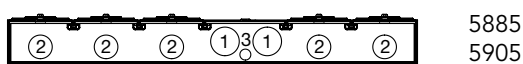
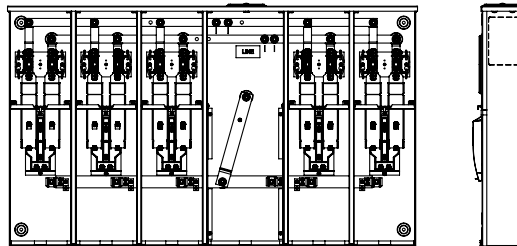
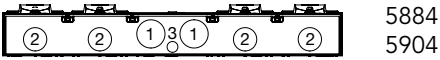
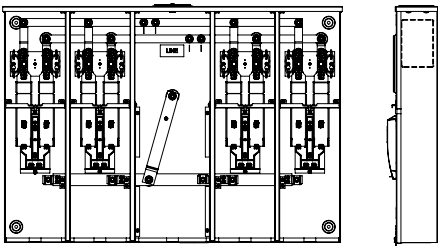
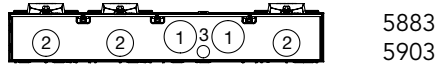
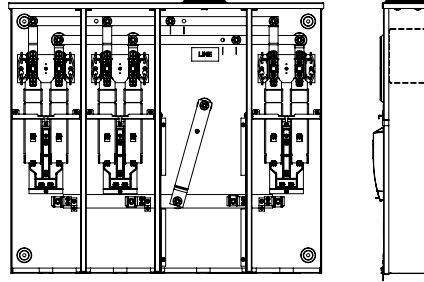
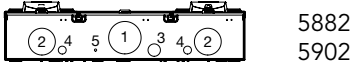
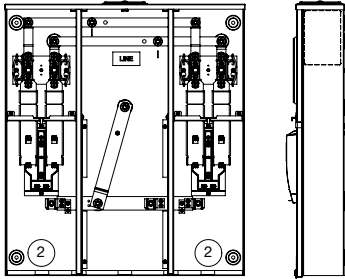

Please consult serving utility for their requirements prior to ordering or installing, as specifications and approvals vary by utility, and may require local electrical inspector approval. All installations must be installed by a licensed electrician and must comply with all national and local codes, laws and regulations. Milbank reserves the right to make changes in specifications and features shown without notice or obligation.

Lever Bypass Multi-Position Meter Main

200 Amp | 5 Terminal | Ringless | 120/240 VAC
Jaw Clamping

35
200 AMP
LEVER BYPASS
MULTI-
POSITION



U4374-Xt-5T9

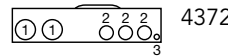
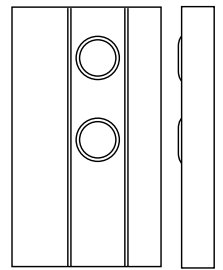

4372

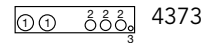
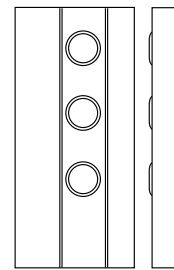

4373

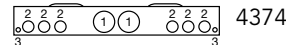
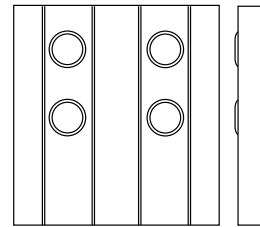

4374

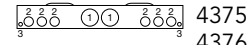
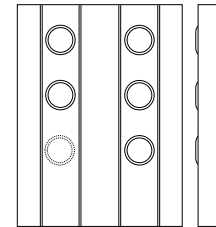

4375

4376

200 Amp per Position | 5 Terminal | Lever Bypass Multi-Position Sockets | Ringless | 1Ø3W

Catalog Number	Positions	Main Bus Rating	Line Connector Size	Dimensions			Knockouts		
				D"	W"	H"	1	2	3
U4372-Xt-5T9	2	320 Amp	3/8" x 16 Stud*	6	27 3/4	48	3	2	1/4, 1/2
U4373-Xt-5T9	3	480 Amp	3/8" x 16 Stud*	6	27 3/4	60	3	2	1/4, 1/2
U4374-Xt-5T9	4	640 Amp	3/8" x 16 Stud*	6	45	48	4	2	1/4, 1/2
U4375-Xt-5T9	5	640 Amp	3/8" x 16 Stud*	6	45	60	4	2	1/4, 1/2
U4376-Xt-5T9	6	640 Amp	3/8" x 16 Stud*	6	45	60	4	2	1/4, 1/2

Connector Kits*

Size	Suffix	Kit Number	Wire Range
Single	-K3	K1540	#4-600
Twin	-K2	K1350	#6-350
	-K4	K1541	#2-600

Breaker Chart

Manufacturer	125-200 Amp	125 Amp or Less
Cutler Hammer	BR, BJ, HQP	Quicklag P BR
Siemens (ITE)	QNR	QP
Siemens (Murray/Crouse Hinds)	MD	MP
G.E.	Q Line	Q Line
Square D	—	Homeline

Notes

- ***Connectors:** For line wire connector kits, order separately (see chart above).
- **Breakers:** Units have provision for one double pole main per meter position. Breakers not included. Order as extra (see chart above).
- **Bypass:** Lever supplies clamping action on meter spades and also operates bypass device.

Please consult serving utility for their requirements prior to ordering or installing, as specifications and approvals vary by utility, and may require local electrical inspector approval. All installations must be installed by a licensed electrician and must comply with all national and local codes, laws and regulations. Milbank reserves the right to make changes in specifications and features shown without notice or obligation.



Multi-Position Meter Mains

200 Amp | Lever Bypass | 22K AIC Rated | 240 VAC
Jaw Clamping

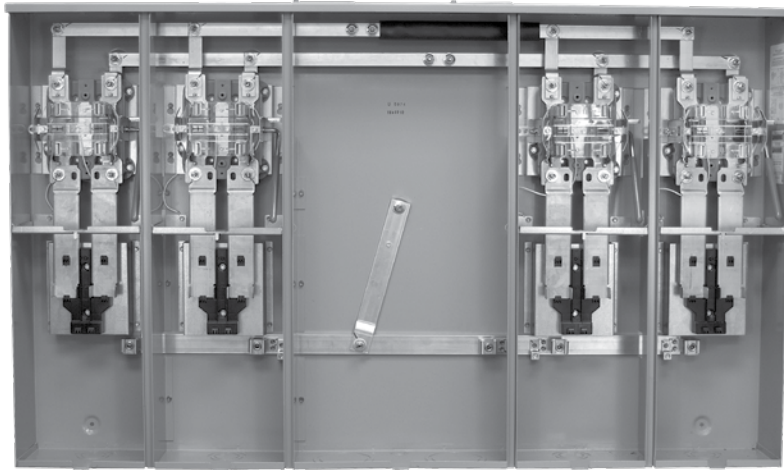

U5974-XT

4 Terminals | Multi-Position Meter Main | Lever Bypass | Ringless

Catalog Number	Amp	Positions	Service	Hub	Bypass	Dimensions			Weight (lbs.)
						D"	W"	H"	
U5972-XT	200	2	OH/UG	(2) C.P.	Lever	5 ³ / ₃₂	36 ³ / ₈	34	97
U5973-XT	200	3	OH/UG	(2) C.P.	Lever	5 ³ / ₃₂	46 ¹ / ₂	34	146
U5974-XT	200	4	OH/UG	(2) C.P.	Lever	5 ³ / ₃₂	57 ¹ / ₁₆	34	179
U5975-XT	200	5	OH/UG	(2) C.P.	Lever	5 ³ / ₃₂	67 ¹ / ₈	34	213
U5976-XT	200	6	OH/UG	(2) C.P.	Lever	5 ³ / ₃₂	77 ¹ / ₁₆	34	246

Notes

- **Knockouts:** See drawings on the next page.
- **AIC Rating:** All models are rated **22K AIC** when used with approved breakers rated at 22K.
- **Hub:** Units supplied with one (1) closing plate. Order hubs separately, see accessories page.
- **Fifth Terminal:** For field installed fifth terminal, order **K3866**.
- **Lug Kits:** Sold separately.
- **Front Covers:** Barrel lock option available—contact factory.

Breaker Chart - 10K AIC (unless noted 22K)

Manufacturer	Cutler Hammer	Siemens	G.E. (50 Amp Max)	Square D
125 Amp or Less	BR, HQP, QPGF	QP, QPH (22K)	THQL, THQL-GF	Homeline
150-200 Amp	—	QN, QNH (22K)	—	—



Please consult serving utility for their requirements prior to ordering or installing, as specifications and approvals vary by utility, and may require local electrical inspector approval. All installations must be installed by a licensed electrician and must comply with all national and local codes, laws and regulations. Milbank reserves the right to make changes in specifications and features shown without notice or obligation.

Multi-Position Meter Mains

U5972–U5976 Series | Knockout Information

37
200 AMP
LEVER BYPASS
MULTI-POSITION
METER MAINS

Knockouts			
1	2	3	4
4	2½	1	½

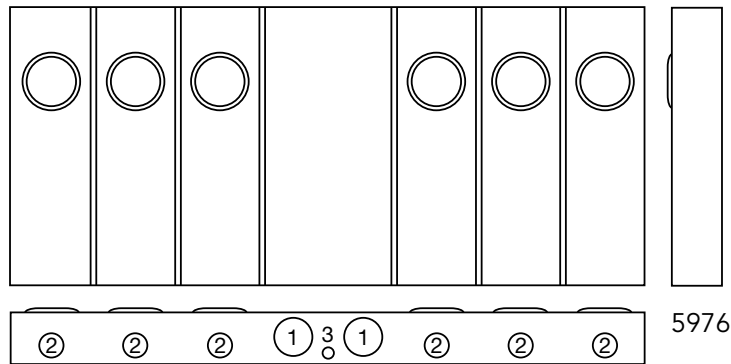
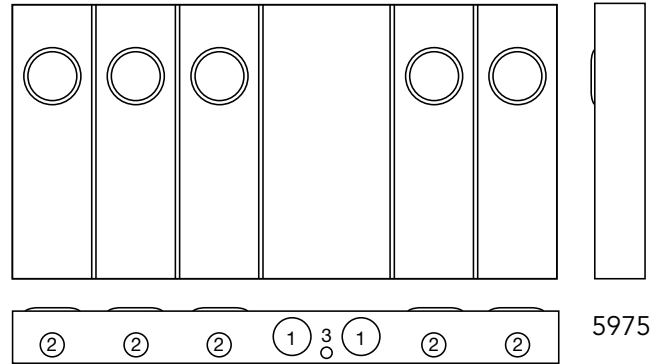
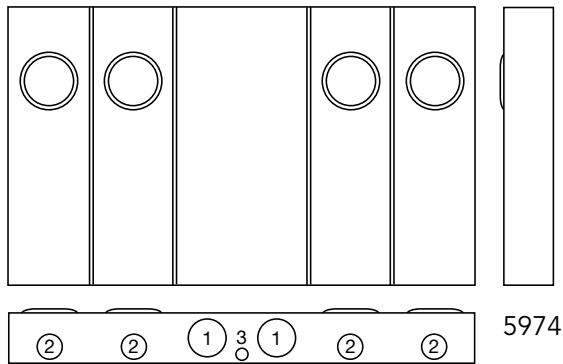
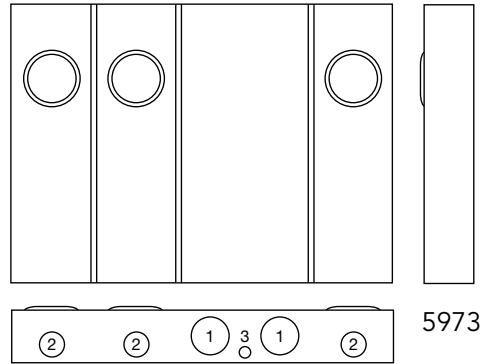
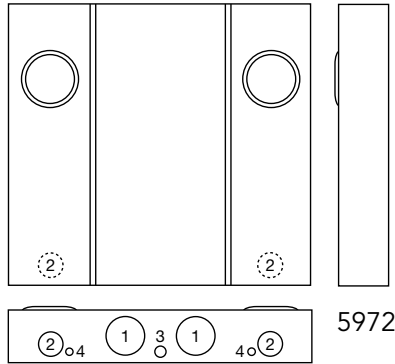

Please consult serving utility for their requirements prior to ordering or installing, as specifications and approvals vary by utility, and may require local electrical inspector approval. All installations must be installed by a licensed electrician and must comply with all national and local codes, laws and regulations. Milbank reserves the right to make changes in specifications and features shown without notice or obligation.



Transformer Rated

20 Amp | 5-13 Terminals | No Test Switch Provision

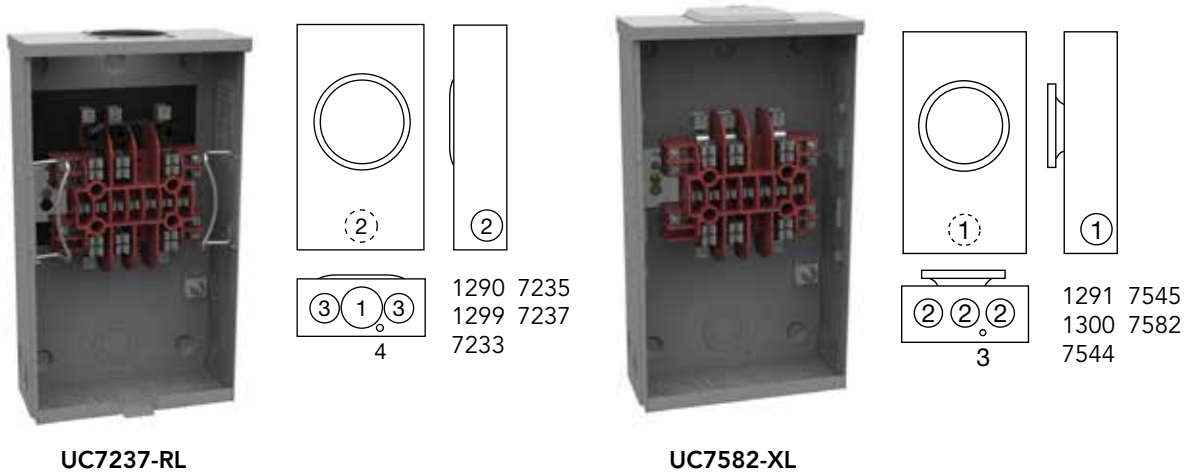

20 Amp | Ringless | **Plunger Bypass** | Overhead / Underground Service

Catalog Number	Terminals	Hub	Meter Form	Connectors CU	Dimensions			Knockouts			
					D"	W"	H"	1	2	3	4
UC1290-XL	5	C.P.	3S	#14 - #10	3 ⁵ / ₁₆	8	14	2	1 ¹ / ₂	1 ¹ / ₄	1 ¹ / ₄
UC1299-XL	6	C.P.	4S	#14 - #10	3 ⁵ / ₁₆	8	14	2	1 ¹ / ₂	1 ¹ / ₄	1 ¹ / ₄
UC7233-XL	7	C.P.	7, 14, 15 & 24S	#14 - #10	3 ⁵ / ₁₆	8	14	2	1 ¹ / ₂	1 ¹ / ₄	1 ¹ / ₄
UC7235-XL	8	C.P.	5S	#14 - #10	3 ⁵ / ₁₆	8	14	2	1 ¹ / ₂	1 ¹ / ₄	1 ¹ / ₄
UC7237-XL	13	C.P.	6, 8, 9S & (ALT) 10S	#14 - #10	3 ⁵ / ₁₆	8	14	2	1 ¹ / ₂	1 ¹ / ₄	1 ¹ / ₄

20 Amp | Ring Type | Overhead / Underground Service

Catalog Number	Terminals	Hub	Meter Form	Connectors CU	Bypass	Dimensions			Knockouts		
						D"	W"	H"	1	2	3
UC1291-RL	5	H.O.	3S	#14 - #4 MAX	Plunger	3 ⁵ / ₁₆	8	14	1 ¹ / ₂	1 ¹ / ₄	1 ¹ / ₄
UC1300-RL	6	H.O.	4S	#14 - #4 MAX	Plunger	3 ⁵ / ₁₆	8	14	1 ¹ / ₂	1 ¹ / ₄	1 ¹ / ₄
UC7544-RL	8	H.O.	5S	#14 - #4 MAX	Plunger	3 ⁵ / ₁₆	8	14	1 ¹ / ₂	1 ¹ / ₄	1 ¹ / ₄
UC7545-RL	13	H.O.	6, 8, 9S & (ALT) 10S	#14 - #4 MAX	Plunger	3 ⁵ / ₁₆	8	14	1 ¹ / ₂	1 ¹ / ₄	1 ¹ / ₄
UC7582-XL	13	C.P.	6, 8, 9S & (ALT) 10S	#14 - #10	None	3 ⁵ / ₁₆	8	14	1 ¹ / ₂	1 ¹ / ₄	1 ¹ / ₄

Notes

- **Hubs:** For proper hub selection, see the hub suffix chart on the accessories page.
- **Bypass:** Plunger type bypass automatically closes when meter is removed.



Please consult serving utility for their requirements prior to ordering or installing, as specifications and approvals vary by utility, and may require local electrical inspector approval. All installations must be installed by a licensed electrician and must comply with all national and local codes, laws and regulations. Milbank reserves the right to make changes in specifications and features shown without notice or obligation.

Transformer Rated

20 Amp | 5-13 Terminals | Test Switch Provision

39
20 AMP
TRANSFORMER
RATED

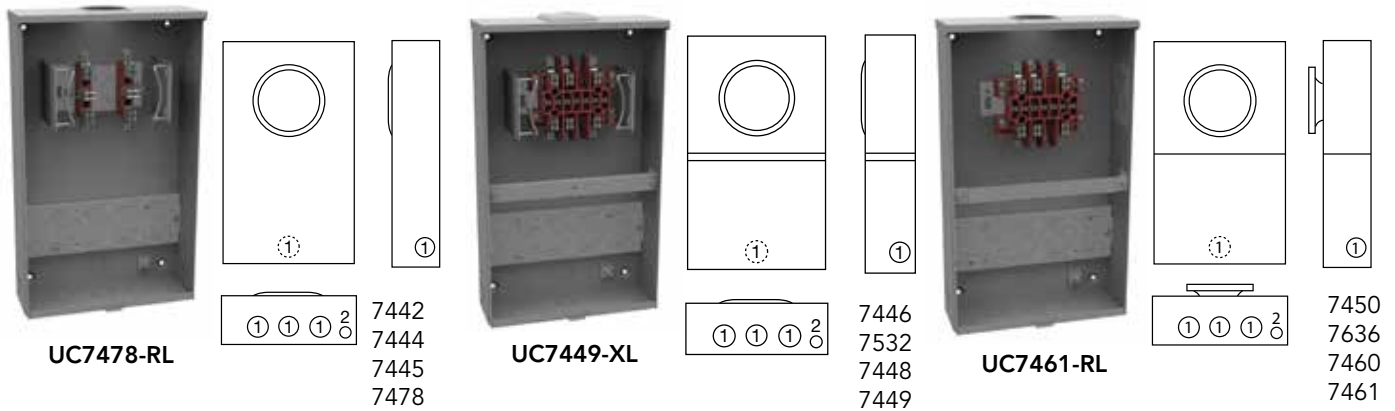

1 Piece Cover | Ringless | Overhead / Underground | with test switch provision*

Catalog Number	Terminals	Hub	Meter Form	Connectors CU	Bypass	Dimensions			Knockouts	
						D"	W"	H"	1	2
UC7442-RL	5	H.O.	3S	#14 - #4 Max	None	4½	12	20	1¼	¼, ½
UC7478-RL	6	H.O.	4S	#14 - #4 Max	None	4½	12	20	1¼	¼, ½
UC7444-RL	8	H.O.	5S	#14 - #4 Max	None	4½	12	20	1¼	¼, ½
UC7445-RL	13	H.O.	6, 8, 9 & (ALT) 10S	#14 - #4 Max	None	4½	12	20	1¼	¼, ½

2 Piece Cover | Overhead / Underground | with test switch provision*

Ringless Catalog Number	Ring Type Catalog Number	Terminals	Hub	Connectors CU	Bypass	Dimensions			Knockouts	
						D"	W"	H"	1	2
UC7446-RL	UC7450-RL	5	H.O.	#14 - #4 Max	None	4½	12	20	1¼	¼, ½
UC7532-RL	UC7636-RL	6	H.O.	#14 - #4 Max	None	4½	12	20	1¼	¼, ½
UC7448-RL	UC7460-RL	8	H.O.	#14 - #4 Max	None	4½	12	20	1¼	¼, ½
UC7449-RL	UC7461-RL	13	H.O.	#14 - #4 Max	None	4½	12	20	1¼	¼, ½

Notes

- **Hubs:** For proper hub selection see the hub suffix chart on the accessory page.
- **Sealing Rings:** Ring type units are supplied with one MR-2, snap type, sealing ring.
- **Prewiring:** If standard factory prewiring is required, refer to wiring diagrams in the general engineering section of this catalog. Determine appropriate diagram and send copy with order. If custom factory prewiring is required, specify on order. Be sure to include meter socket catalog number, test switch model and number, and meter form number. Please be sure to provide a copy of your wiring diagram.
- **Connectors:** Units are supplied with mechanical type connectors (#4 max). If compression type connectors (#10) are preferred, change catalog prefix to "S" (i.e. UC7445-XL becomes S7445-XL). The "S" prefix also designates non-U/L.
- ***Test Switch Cover:** Units on this page are not designed for use with test switch covers.

Please consult serving utility for their requirements prior to ordering or installing, as specifications and approvals vary by utility, and may require local electrical inspector approval. All installations must be installed by a licensed electrician and must comply with all national and local codes, laws and regulations. Milbank reserves the right to make changes in specifications and features shown without notice or obligation.



Lever Bypass Transformer Rated

20 & 80 Amp | 6, 8 & 13 Terminal | Ringless | 600 VAC



U4490-XL

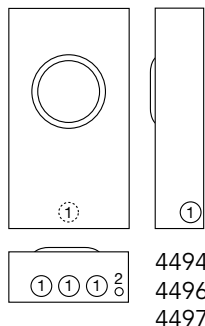
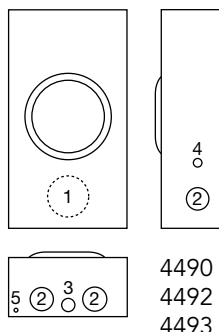

U4497-XL

80 Amp | Ringless | Transformer Rated | Lever Bypass

Catalog Number	Terminals	Hub	Service	Connectors CU	Bypass	Dimensions			Knockouts				
						D"	W"	H"	1	2	3	4	5
U4490-XL	6	C.P.	OH/UG	#14 - #4 Max	Lever	4 ⁷ / ₈	10	18 ¹ / ₂	3	1 ¹ / ₂	1 ¹ / ₂ , 3 ³ / ₄	3 ³ / ₄	1 ¹ / ₄
U4492-XL	8	C.P.	OH/UG	#14 - #4 Max	Lever	4 ⁷ / ₈	10	18 ¹ / ₂	3	1 ¹ / ₂	1 ¹ / ₂ , 3 ³ / ₄	3 ³ / ₄	1 ¹ / ₄
U4493-XL	13	C.P.	OH/UG	#14 - #4 Max	Lever	4 ⁷ / ₈	10	18 ¹ / ₂	3	1 ¹ / ₂	1 ¹ / ₂ , 3 ³ / ₄	3 ³ / ₄	1 ¹ / ₄

*20 Amp | Ringless | Transformer Rated | Lever Bypass | With Provision for Test Switch

Catalog Number	Terminals	Hub	Meter Form	Connectors CU	Bypass	Dimensions			Knockouts	
						D"	W"	H"	1	2
U4494-XL	6	C.P.	OH/UG	#14 - #4 Max	Lever	4 ⁷ / ₈	12	22	1 ¹ / ₂	1 ¹ / ₄ , 1 ¹ / ₂
U4496-XL	8	C.P.	OH/UG	#14 - #4 Max	Lever	4 ⁷ / ₈	12	22	1 ¹ / ₂	1 ¹ / ₄ , 1 ¹ / ₂
U4497-XL	13	C.P.	OH/UG	#14 - #4 Max	Lever	4 ⁷ / ₈	12	22	1 ¹ / ₂	1 ¹ / ₄ , 1 ¹ / ₂

Notes

- **Bypass:** Lever operates current bypass devices and also supplies clamping action on current meter spades.
- ***Prewiring:** If standard factory prewiring is required, refer to wiring diagrams in the general engineering section of this catalog. Determine appropriate diagram and send copy with order. If custom factory prewiring is required, specify on order. Be sure to include meter socket catalog number, test switch model and number, and meter form number. Please be sure to provide a copy of your wiring diagram.
- ***Test Switch Cover:** Units on this page can be used with clear lexan cover. See accessories page for ordering information.
- ***Block Assembly:** Block assembly rated at 80 amps and test switch rated at 20 amps; therefore, unit defaults to test switch rating of 20 amps.
- **Connectors:** Units are supplied with mechanical type connectors (#4 max). If compression type connectors (#10) are preferred, change catalog prefix to "S" (i.e. U4494-XL becomes S4494-XL). The "S" prefix also designates non-U/L.



Please consult serving utility for their requirements prior to ordering or installing, as specifications and approvals vary by utility, and may require local electrical inspector approval. All installations must be installed by a licensed electrician and must comply with all national and local codes, laws and regulations. Milbank reserves the right to make changes in specifications and features shown without notice or obligation.

Milbank Test Switches

4, 7, & 10 Pole

41
CURRENT
TRANSFORMER
TEST SWITCHES

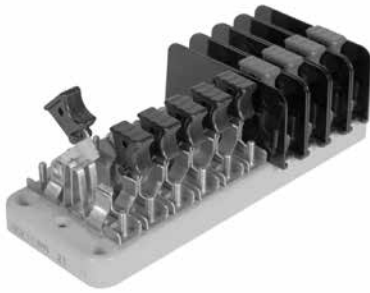

SWITCH BLADES

Two dimples coined into one side of the switch blade ensure positive contact in corrosive, sooty environments – even after years of inactivity.



TEST SWITCH BASE

The base is molded from a high strength, fiberglass reinforced, thermoset polyester. This material is track resistant, flame retardant and has low water absorption qualities. Bases are available in 7 pole and 10 pole sizes.



POLARITY BARRIER

For maximum protection potential circuits are supplied with permanently mounted, rigid barriers made from high tensile strength, polycarbonate.

TEST SWITCH COVERS

Standard test switch covers are made from break resistant, clear, thermal plastic which has excellent tracking and moisture resistant properties. If covers are required, add suffix “-WC” (with cover) to the catalog number or order separately catalog number K3388. Black flush mount covers are also available. Order catalog number K3388-BLK-FL. 10 pole base only.

SWITCH JAWS

The switch blade jaw clips are constructed from spring grade copper alloy. The material and design ensure excellent contact which prevents overheating.

CURRENT CARRYING PARTS

Highly conductive copper and copper alloy materials are used on all current carrying parts. This ensures conductivity and deters corrosion. Spring grades are used where appropriate. Plating is available if required. Contact general offices to special order.

STANDARD COVER



K3388

Units must be
5-1/8" deep
for Cover

FLUSH MOUNT COVER BLACK



K3388-BLK-FL

Notes

- **Factory Installed:** For cover installed add the suffix **-WC** or **-WCFL** to the catalog number of desired test switch
- **Field Installed:** For field installed cover order kit number **K3388** or **K3388-BLK-FL**.

The MILBANK test switch is designed to meet the critical requirements of the electric utility industry. Not only do they meet EEI, ANSI C12.9, and UL standards but they combine several special features giving the MILBANK test switch increased safety, durability and reliability. One such feature is our unique switch blade contact points which cut through residue that builds up after years of service. Another distinction is our polarity barrier which is designed to be flexible as well as offer exceptional insulating qualities. Our test switches are constructed from the latest materials available using modern fabricating and assembly methods.

Please consult serving utility for their requirements prior to ordering or installing, as specifications and approvals vary by utility, and may require local electrical inspector approval. All installations must be installed by a licensed electrician and must comply with all national and local codes, laws and regulations. Milbank reserves the right to make changes in specifications and features shown without notice or obligation.



42

CURRENT
TRANSFORMER
TEST SWITCHES

Current Transformer Test Switches

4, 7, & 10 Pole | 600 VAC | Per Ansi C12.9 Standard

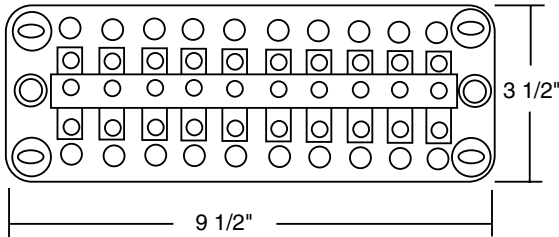
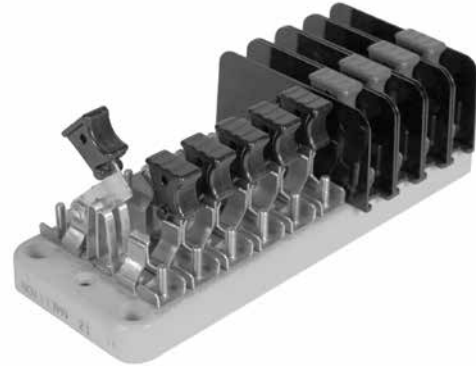
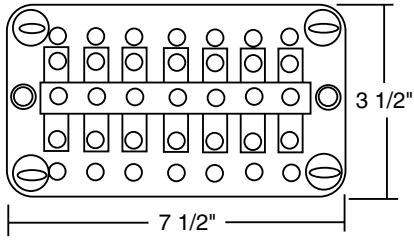

Catalog Number	4-Pole						
TS04-0101	X	P	Pn	X	C+	C	X
TS04-0104	X	C+	C	X	P	Pn	X

KEY	
P	Potential Switch
C+	Line side current switch with short circuit assembly
C	Load side current switch with test jack assembly
N	Neutral bar (no switch)
Pn	Neutral potential switch
X	Unused position on base
	Line side current switch with short circuit assembly

Catalog Number	7-Pole						
TS07-0105	P	P	Pn	C+	C	C+	C

Catalog Number	7-Pole on a 10-pole base									
TS07-0049	P	X	P	X	Pn	X	C+	C	C	C+
TS07-0106	X	P	C+	C	P	C+	C	Pn	X	X

CUSTOM POLE ARRANGEMENTS

The key may be used to diagram your own pole arrangement. Be sure to specify base size and whether all C+ line side, current switch / shunt circuit assemblies are to be bussed together. The catalog numbers shown above are connected in line-load pairs; therefore, if bussed is required, different catalog numbers will apply.

Catalog Number	10-Pole									
TS10-0109	P	P	P	Pn	C+	C	C+	C	C+	C
TS10-0110	P	C+	C	P	C+	C	P	C+	C	Pn
TS10-0111	P	P	P	Pn	C	C+	C	C+	C	C+
TS10-0112	C+	C	C+	C	C+	C	P	P	P	Pn
TS10-0016	P	P	P	PN	C	C+	C	C+	C	C+



Please consult serving utility for their requirements prior to ordering or installing, as specifications and approvals vary by utility, and may require local electrical inspector approval. All installations must be installed by a licensed electrician and must comply with all national and local codes, laws and regulations. Milbank reserves the right to make changes in specifications and features shown without notice or obligation.

Milbank Test Switch Worksheet



TEST SWITCH BASE

The base is molded from a high strength, fiberglass reinforced, thermoset polyester. This material is track-resistant, flame-retardant and has low water absorption qualities. Bases are available in two standard sizes following NEMA mounting classifications.

Customer Name: _____

Address: _____

Phone/Email: _____ / _____

Handle Color Key							
BK	Black	P	Purple	Y	Yellow	GN	Green
R	Red	BL	Blue	W	White	BKS	BK/Stripe
BR	Brown	GR	Grey	O	Orange	WS	W/Stripe

Pole Position Chart

1	2	3	4	5	6	7	8	9	10

Special Features

Features	1	2	3	4	5	6	7	8	9	10

Engineering Information: _____

KEY	
P	Potential Switch
C+	Line side current switch with short circuit assembly
C	Load side current switch with test jack assembly
N	Neutral bar (no switch)
Pn	Neutral potential switch
X	Unused position on base
	Line side current switch with short circuit assembly

Custom Pole Arrangements: The key may be used to diagram your own pole arrangement. Be sure to specify base size and whether all C+ line side, current switch / shunt circuit assemblies are to be bussed together. The catalog numbers shown above are connected in line-load pairs; therefore, if bussed is required, different catalog numbers will apply.

Number of Poles

- 4
 7
 10
 Other _____

Test Switch Cover*

- Yes ___ Clear ___ Black
 No

Base Size

- 7-Pole
 10-Pole

* Test switch covers are only available for 10-pole bases.

Please consult serving utility for their requirements prior to ordering or installing, as specifications and approvals vary by utility, and may require local electrical inspector approval. All installations must be installed by a licensed electrician and must comply with all national and local codes, laws and regulations. Milbank reserves the right to make changes in specifications and features shown without notice or obligation.



44

CURRENT
TRANSFORMER
CABINET

Current Transformer Cabinet

Panel Enclosure | Type 3R

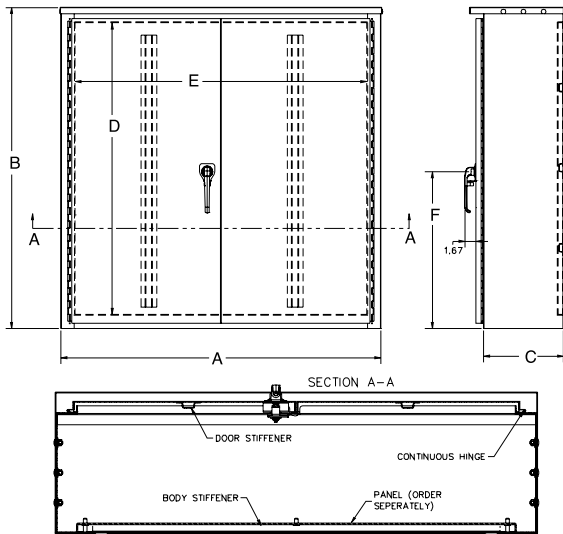

Application

- Designed for use as a current transformer cabinet or panel enclosure.
- For outdoor use to provide protection against rain, sleet and snow, or indoor use to protect against dripping water.

Construction

- Enclosure and cover manufactured from 16 or 14 gauge G90U galvanized steel.
- The doors are overlapping with no center post.
- Continuous door hinge with stainless steel hinge pins.
- Three point pad-lockable handle.
- Panel mounting studs provided for optional back panels.
- Drip shield top and seam-free sides, front and back.

Finish

- ANSI 61 gray polyester powder coating over phosphatized G90U galvanized steel.

Current Transformer Cabinets | Panel Enclosure | CN3R

Catalog Number	UPC # (7-84572)	Weight	Dimensions			Steel Panel Catalog #	Wood Panel Catalog #
			D"	W"	H"		
363010-CT3R	18823	99	36	30	10	A-36P30	A-36P30W
363016-CT3R	16181	121.5	36	30	16	A-36P30	A-36P30W
363610-CT3R	17368	113	36	36	10	A-36P36	A-36P36W
363612-CT3R	16185	118	36	36	12	A-36P36	A-36P36W
363616-CT3R	18819	139	36	36	16	A-36P36	A-36P36W
483616-CT3R	25707	163	48	36	16	A-48P36	A-48P36W
484812-CT3R	16184	210	48	48	12	A-48P48	A-48P48W
606013-CT3R	18252	274	60	60	13	A-60P60	A-60P60W



Please consult serving utility for their requirements prior to ordering or installing, as specifications and approvals vary by utility, and may require local electrical inspector approval. All installations must be installed by a licensed electrician and must comply with all national and local codes, laws and regulations. Milbank reserves the right to make changes in specifications and features shown without notice or obligation.

Transformer Cabinets

45
TRANSFORMER
RATED



CT364811-HC
Shown with K5930 current
transformer rack installed



PT48AL*
PT48AR*



S7860

Hinge Cover Transformer Cabinets

Catalog Number	C.T. Racks**	Dimensions			Front Cover	Cover Type
		D"	W"	H"		
CT244811-SC	A	11	24	48	1 Piece	Screw
CT304811-SC	A, B, G, H	11	30	48	1 Piece	Screw
CT364811-SC	A, B, G, H	11	36	48	1 Piece	Screw
CT244811-HC	A	11	24	48	1 Piece	Hinge
CT304811-HC	A, B, G, H	11	30	48	1 Piece	Hinge
CT364811-HC	A, B, G, H	11	36	48	1 Piece	Hinge

PT Cabinets

Catalog Number	Dimensions			Knockout
	D"	W"	H"	
PT48AL	8	12	36	2½" - right side
PT48AR	8	12	36	2½" - left side

Notes

- ***PT48:** **PT48L** and **PT48AL** has mounting emboss on the right side to be mounted on left side of CT cabinet. **PT48R** and **PT48AR** have mounting emboss on left side to be mounted on right side of CT cabinet.
- ****Mounting Rack:** Select CT mounting rack from next page.
- **Enclosure:** These units are rated Type 3R, powder coated and constructed of galvanized steel.
- **Wall or Pole Mount:** For wall or pole mount CT rack order **S7860**. This unit accomodates 3 donut style CTs. The removable cover makes wiring much easier.
- **Mounting:** ¼ - 20 welded studs.

Please consult serving utility for their requirements prior to ordering or installing, as specifications and approvals vary by utility, and may require local electrical inspector approval. All installations must be installed by a licensed electrician and must comply with all national and local codes, laws and regulations. Milbank reserves the right to make changes in specifications and features shown without notice or obligation.



CT Cabinet Mounting Racks

Stud & Lug Type



K4797 (studs)



K4798 (studs)

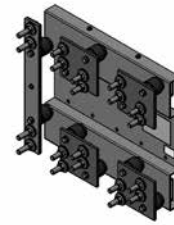

K5932 (studs)

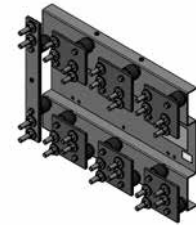

K5933 (studs)



K4729 (with lugs)



K4722 (with lugs)

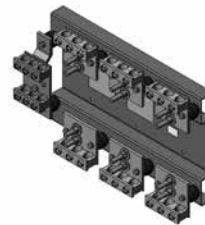

K5930 (with lugs)

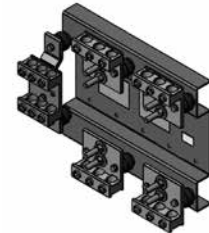

K5931 (with lugs)

Hinge Cover Transformer Cabinets

Code	Catalog Number	AIC Rating	Amp	Volts	Type of Service	Termination Type
A	K4797	50K	800	600	1Ø3W or 3Ø3W	½ - 13 studs on 1¾" centers
B	K4798	50K	800	600	3Ø4W	½ - 13 studs on 1¾" centers
G	K4729	50K	800	600	1Ø3W or 3Ø3W	6 lugs: (3) #4-600 or (6) #1-250
H	K4722	50K	800	600	3Ø4W	8 lugs: (3) #4-600 or (6) #1-250
H	K5930	50K	800	600	3Ø4W	8 lugs: (3) #4-600 or (6) #1-250
G	K5931	50K	800	600	1Ø3W or 3Ø3W	6 lugs: (3) #4-600 or (6) #1-250
A	K5932	50K	800	600	1Ø3W or 3Ø3W	½ - 13 studs on 1¾" centers
B	K5933	50K	800	600	3Ø4W	½ - 13 studs on 1¾" centers

Notes

- Select CT enclosures from previous page.
- **PT Cabinets:** PT Cabinets are required on all 277/480V installations.



Please consult serving utility for their requirements prior to ordering or installing, as specifications and approvals vary by utility, and may require local electrical inspector approval. All installations must be installed by a licensed electrician and must comply with all national and local codes, laws and regulations. Milbank reserves the right to make changes in specifications and features shown without notice or obligation.

Transockets

400 Amp | 6, 8 & 13 Terminals | Use with bar-type CTs

47
400 AMP
TRANSOCKETS



U2161-XT
(pre-wired as example only)

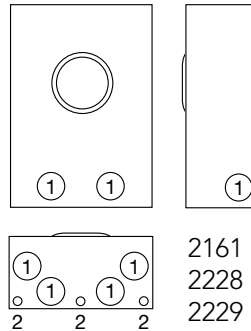

U2161-XT
(interior shown)

NOTE

Units priced without transformers or test switch. Contact general office for ordering information.

For use with bar-type CTs.
There is no provision for PTs in these units.
200 / 5
300 / 5
400 / 5

400 Amp | 6, 8 & 13 Terminal | Transockets | Ringless

Catalog Number	Terminals	Hub	Meter Form	Connectors	Current Transformer Mountings	Dimensions			Knockouts	
						D"	W"	H"	1	2
U2228-XT	6	(2) C.P.	4S	500	½"-13 Twin Studs	12	24	36	4	1
U2229-XT	8	(2) C.P.	5S	500	½"-13 Twin Studs	12	24	36	4	1
U2161-XT	13	(2) C.P.	6, 8, 9S	500	½"-13 Twin Studs	12	33⅙	35	4	1

Notes

- **Hubs:** Units are supplied with two closing plates as standard. To order hubs as extra refer to the hub suffix chart on the accessory page.
- **Studs:** ½"-13 twin studs are supplied to mount bar type transformers. Hex nuts with Belleville washers are also supplied.
- **Prewiring:** If standard factory prewiring is required, refer to wiring diagrams in the general engineering section of this catalog. Determine appropriate diagram and send copy with order. If custom factory prewiring is required, specify on order. Be sure to include meter socket catalog number, test switch model and number, meter form number, and a copy of your wiring diagram. If C.T.s are to be factory installed, specify C.T. ratio.

Please consult serving utility for their requirements prior to ordering or installing, as specifications and approvals vary by utility, and may require local electrical inspector approval. All installations must be installed by a licensed electrician and must comply with all national and local codes, laws and regulations. Milbank reserves the right to make changes in specifications and features shown without notice or obligation.



600 Amp | 6, 8, 13 & 14 Terminals | Donut or Bar Type CTs

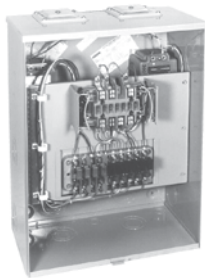

S1890-XT



S2690-XT

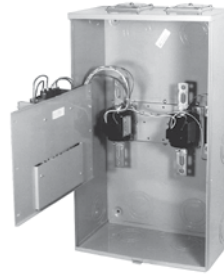

S2690-XT



AP6014-O-400-NKO
(shown factory prewired)

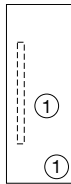
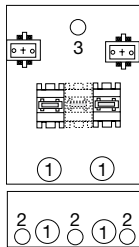

1890
1891
3912

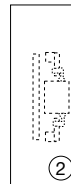
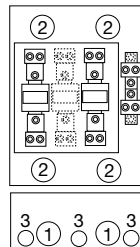

2674
2690
3831

600 Amp / 600 Volt | With PTs and Donut Type CTs | Ringless

Catalog Number	Terminals	Hub	Meter Form	PTs Quantity & Ratio	CTs Quantity & Ratio	Dimensions			Knockouts		
						D"	W"	H"	1	2	3
S1891-XT	8	(2) C.P.	5S	(2) 4:1	(2) 200/5	9½	18	24	2½	1	1½/₁₆
S3912-XT	13	(2) C.P.	6S	(2) 2.5:1	(3) 200/5	9½	18	24	2½	1	1½/₁₆
S1890-XT	14	(2) C.P.	6S	(2) 2.5:1	(3) 200/5	9½	18	24	2½	1	1½/₁₆

600 Amp / 600 Volt | Bar Type CTs Only | Ringless

Catalog Number	Terminals	Hub	Meter Form	CTs Quantity & Ratio	Dimensions			Knockouts		
					D"	W"	H"	1	2	3
S3831-XT	6	(2) C.P.	4S	(2) 200/5	11¼	18	30	4	3½	1
S2690-XT	8	(2) C.P.	5S	(2) 200/5	11¼	18	30	4	3½	1
S2674-XT	13	(2) C.P.	8S	(3) 200/5	11¼	18	30	4	3½	1

400–1000 Amp | 8 & 13 Terminals | Ringless | Transocket

Catalog Number	Terminals	Service	Phase	Test Switch	Hub	VT Pack Provision	CTs Qty. & Ratio	Dimensions			Knockouts
								D"	W"	H"	
AP6015-O-400-NKO	8	OH/UG	1Ø or 3Ø3W	7-pole	Blank	Yes	(2) 400/5	12¼/₁₆	36	37	None
AP6014-O-400-NKO	13	OH/UG	3Ø4W	10-pole	Blank	Yes	(3) 400/5	12¼/₁₆	36	37	None

Notes

- **Hubs:** Units are supplied with two closing plates as standard. To order hubs as extra refer to the hub suffix chart on the accessory page.
- **Prewiring:** Units supplied prewired with test switch and transformers in place. Contact factory if wiring diagram is desired.
- **Pricing:** Contact general office for pricing information.



Please consult serving utility for their requirements prior to ordering or installing, as specifications and approvals vary by utility, and may require local electrical inspector approval. All installations must be installed by a licensed electrician and must comply with all national and local codes, laws and regulations. Milbank reserves the right to make changes in specifications and features shown without notice or obligation.

Transockets

1200-1600 Amp | 14 Terminal

49

1200-1600 AMP
TRANSOCKETS



S2777-4X



S2777-4X

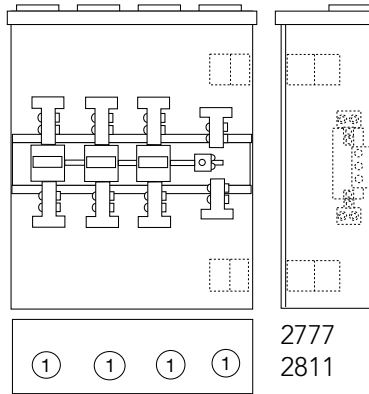

1200-1600 Amp | With PTs and Bar Type CTs | Ringless | 3Ø4W

Catalog Number	Terminals	Hub	Meter Form	PTs Quantity & Ratio	CTs Quantity & Ratio	Dimensions			Knockouts
						D"	W"	H"	1
S2777-4X	14	(4) C.P.	6S	(2) 2.5:1	(3) 400/5	14	30	42	½
S2811-4X	14	(4) C.P.	8S	NONE	(3) 400/5	14	30	42	½

Notes

- **Hubs:** Units are supplied with two closing plates as standard. To order hubs as extra refer to the hub suffix chart on the accessory page.
- **Prewiring:** Units supplied prewired with test switch and transformers in place. Contact factory if wiring diagram is desired.

Please consult serving utility for their requirements prior to ordering or installing, as specifications and approvals vary by utility, and may require local electrical inspector approval. All installations must be installed by a licensed electrician and must comply with all national and local codes, laws and regulations. Milbank reserves the right to make changes in specifications and features shown without notice or obligation.



Residential Pedestal

200 Amp | 4 Terminal | Single or Double Position

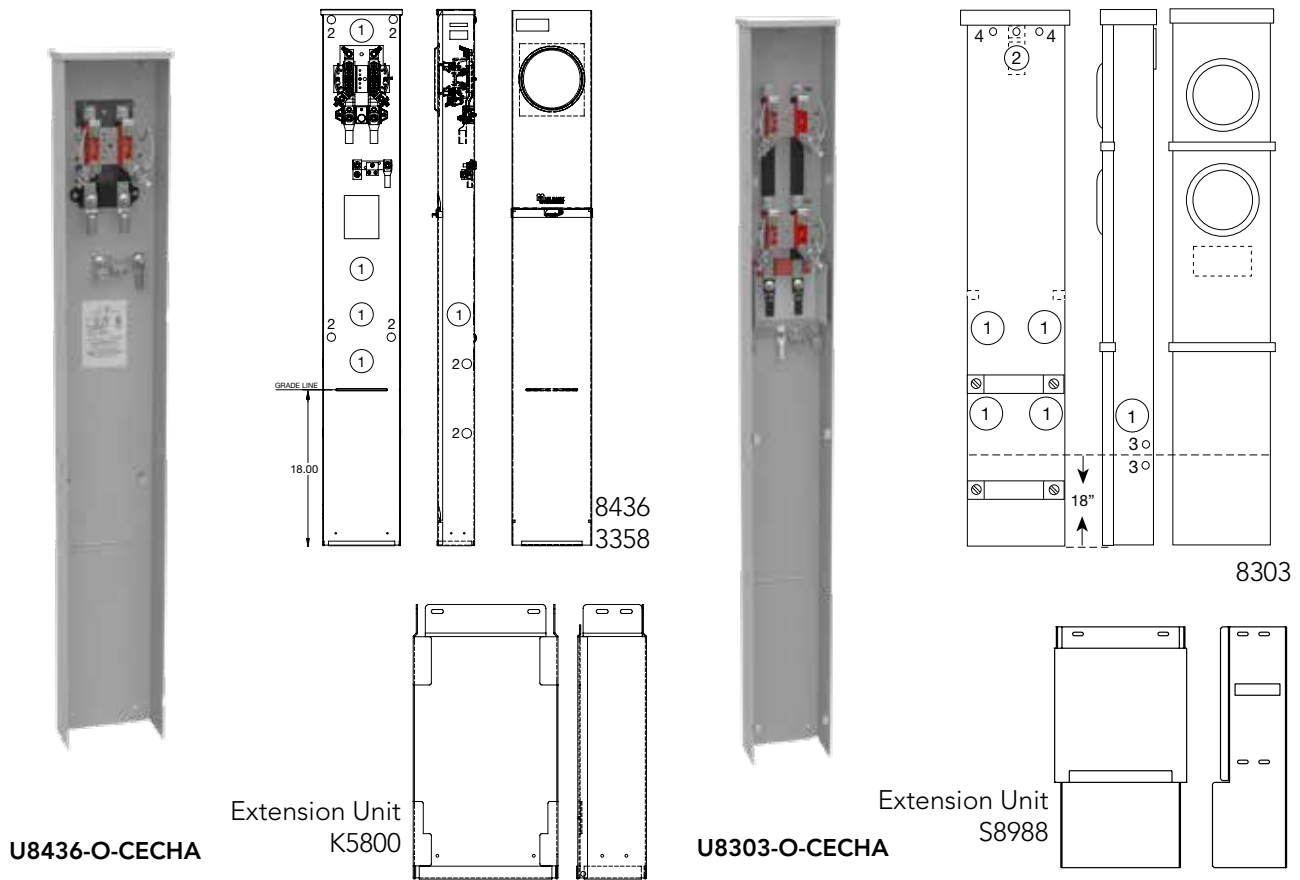

200 Amp | 4 Terminal | Ringless | Horn Bypass | 1Ø3W | Residential Pedestal

Catalog Number	Service	Hub	Number of Pos.	Connectors CU/AL		Dimensions			Knockouts				
				Line	Load	D"	W"	H"	1	2	3	4	
U3358-O-KK	UG	Blank	Single	#6-350	#6-350	4 $\frac{1}{8}$	9	62	2	1 $\frac{1}{4}$, 1 $\frac{1}{2}$	—	—	—
U8436-O-CECHA*	UG	Blank	Single	4/0 (Line) 2/0 (Neutral)	#6-350	4 $\frac{1}{8}$	9	62	2	1 $\frac{1}{4}$, 1 $\frac{1}{2}$	—	—	—
U8303-O-CECHA*	UG	Blank	Double	4/0 (Line) 2/0 (Neutral)	#6-350	4 $\frac{1}{2}$	8 $\frac{3}{16}$	74	2 $\frac{1}{2}$	1 $\frac{3}{4}$	1 $\frac{1}{4}$, 1 $\frac{1}{2}$	5 $\frac{1}{16}$	—

Notes

- **Hanging Hook:** Supplied with keyhole hanger for easy mounting.
- **Extension Unit:** For **U8436**, order extension unit **K5800** for 15" burial applications and two **K5800** units for 30" burial applications. For **U8303**, order extension kit **S8988** for 24" burial applications.
- **Fifth Terminal:** For field installed fifth terminal, order catalog number **K5T**.
- ***Compression Lug:** **U8436** and **U8303**



Please consult serving utility for their requirements prior to ordering or installing, as specifications and approvals vary by utility, and may require local electrical inspector approval. All installations must be installed by a licensed electrician and must comply with all national and local codes, laws and regulations. Milbank reserves the right to make changes in specifications and features shown without notice or obligation.

Lever Bypass Meter Pedestals

100-200 Amp | 5 & 7 Terminal | Ringless | 600 VAC | Jaw Clamping

51
100-200 AMP
LEVER BYPASS
METER PEDESTAL

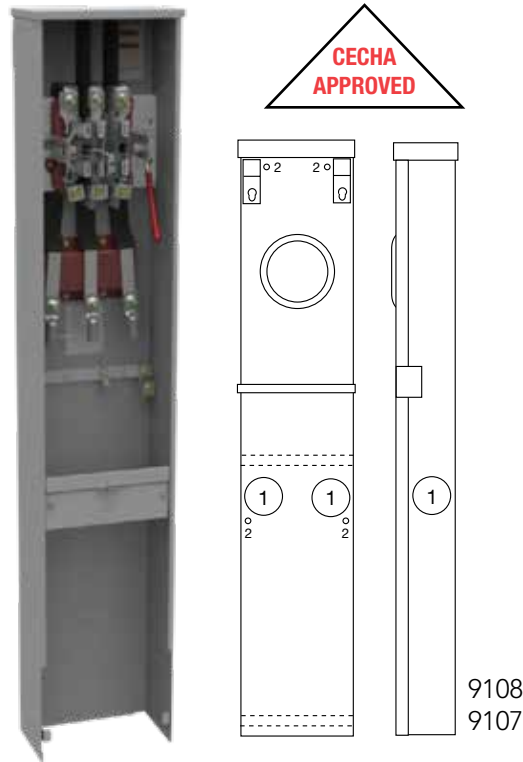

U9107-O-CECHA

100-200 Amp | Metered Pedestals | Lever Bypass | Ringless

Catalog Number	Terminals	Phase	Service	Hub	Connectors CU/AL		Dimensions			Knockouts	
					Line	Load	D"	W"	H"	1	2
U9108-O-CECHA*	5	1Ø3W or 3Ø3W	UG	Blank	3/0-4/0	#6-350	6	11	58	2½	5/16
U9108-O-WI	5	1Ø3W or 3Ø3W	UG	Blank	3/0-4/0	#6-350	6	11	58	2½	5/16
U9107-O-CEHCA*	7	3Ø4W	UG	Blank	3/0-4/0	#6-350	6	11	58	2½	5/16
U9107-O-WI	7	3Ø4W	UG	Blank	3/0-4/0	#6-350	6	11	58	2½	5/16

Notes

- **Bypass:** Lever supplies clamping action on meter spades and also operates bypass device.
- **Neutral Disconnect:** The **U9108** has a manual neutral disconnect bolt.
- **Direct Burial:** For free standing use, order separately burial kit **S3488**.
- **Fifth Terminal:** **U9108** Includes factory installed fifth terminal at 6 o'clock.
- **Compression Lugs:** on **CECHA** versions.

Please consult serving utility for their requirements prior to ordering or installing, as specifications and approvals vary by utility, and may require local electrical inspector approval. All installations must be installed by a licensed electrician and must comply with all national and local codes, laws and regulations. Milbank reserves the right to make changes in specifications and features shown without notice or obligation.



Meter Main Pedestal

100-200 Amp | 4 Terminal | Ringless

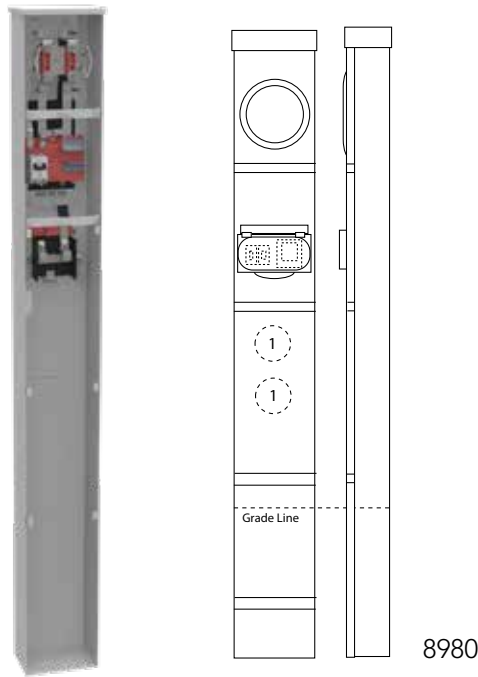

NU8980-O-KK

100-200 Amp | 4 Terminal | Ringless | Underground Service

Catalog Number	Hub	Connectors CU/AL		Hub	Dimensions			Knockouts
		Line	Load		D"	W"	H"	1
NU8980-O-KK	Blank	#6-350	CB*	Horn	6	9	79	2½
NU8980-O-KK-LP	Blank	#6-350	CB*	Horn	6	9	70	2½
NU8980-O-SF100-KK	Blank	#6-350	#6-1/0	Horn	6	9	79	2½
NU8980-O-SF100-KK-LP	Blank	#6-350	#6-1/0	Horn	6	9	70	2½
NU8980-O-200-KK	Blank	#6-350	1/0-300	Horn	6	9	79	2½
NU8980-O-200-KK-LP	Blank	#6-350	1/0-300	Horn	6	9	70	2½

Notes

- * **Field Installed Circuit Breaker Required.**
- **Series Wired Main:** For series wired main order wire kit **K5194** and **UQFPH-M** type circuit breaker.
- **Branch Circuit Breakers:** Branch interior accepts most manufacturers' small frame plug-in type circuit breakers (Milbank, GE, Siemens, Cutler-Hammer, Murray).
- **SF:** SF in catalog number has small frame plug-in type circuit breaker installed on middle stabs of 4-circuit interior. Only two single pole space available.
- **Fifth Terminal:** For field-installed 5th terminal order kit. Mounts in 9 o'clock position only.
- **Bypass:** All pedestals have horn-type bypass installed for meter testing or replacement without interrupting customer service.
- **Extension Kit:** Available for low profile (-LP) units only. Order kit **K4694**.



Please consult serving utility for their requirements prior to ordering or installing, as specifications and approvals vary by utility, and may require local electrical inspector approval. All installations must be installed by a licensed electrician and must comply with all national and local codes, laws and regulations. Milbank reserves the right to make changes in specifications and features shown without notice or obligation.

Meter Main w/ Load Center Pedestal

100-200 Amp | 4 Terminal | Ringless

53
100-200 AMP
METER MAIN
PEDESTAL

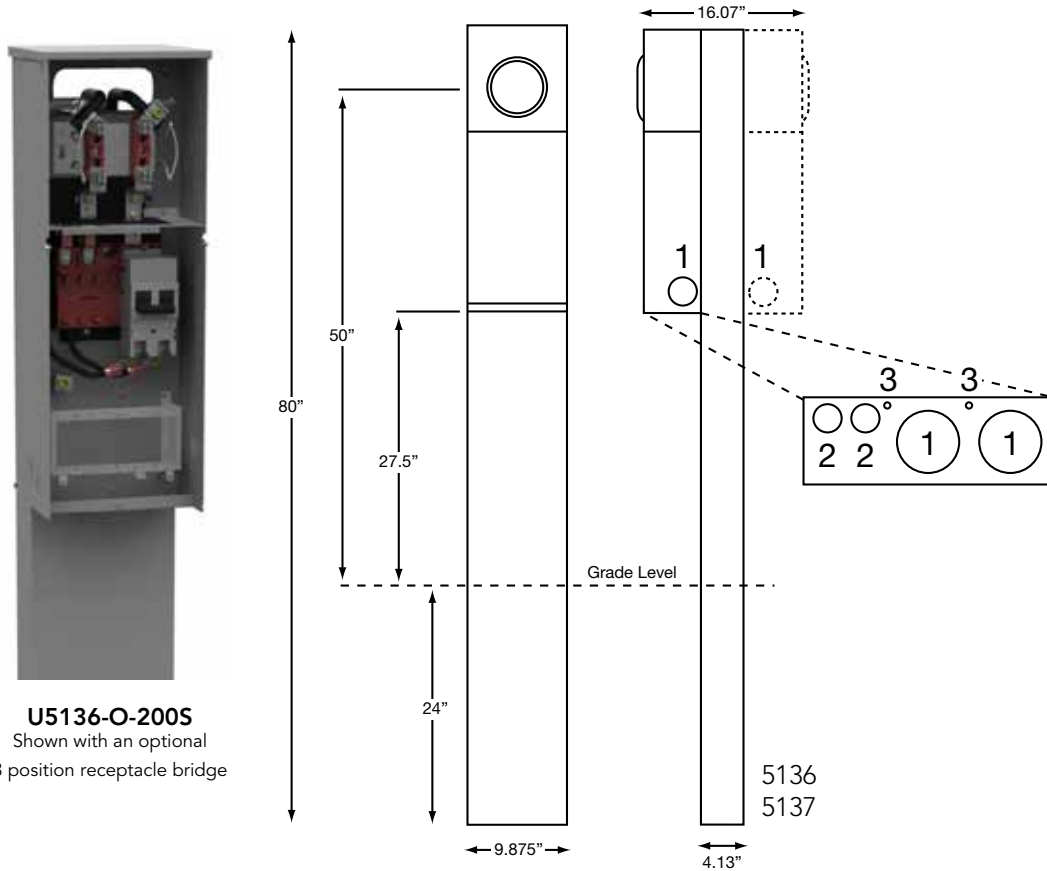

U5136-O-200S
Shown with an optional
3 position receptacle bridge

100-200 Amp | 4 Terminal | Meter Main Pedestal | Ringless

Catalog Number	Service	Meter Positions	Bypass	Connectors CU/AL		Knockouts		
				Line	Load	1	2	3
U5136-O-100S	UG	Single	Horn	#6-350	CB	2	1/2, 3/4	1/4
U5136-O-200S	UG	Single	Horn	#6-350	CB	2	1/2, 3/4	1/4
U5137-O-100S	UG	Double	Horn	#6-350	CB	2	1/2, 3/4	1/4
U5137-O-200S	UG	Double	Horn	#6-350	CB	2	1/2, 3/4	1/4

Notes

- **Fifth Terminal:** For field installed fifth terminal, order **K5T**.
- **Stabilizer Foot:** For field installed stabilizer foot, order **K5415**.
- **Penta Bolt Locking:** For field installed pedestal fronts penta bolt locking, order **K5039**.
- **Receptacles:** Consult factory for installed receptacle assemblies.

Please consult serving utility for their requirements prior to ordering or installing, as specifications and approvals vary by utility, and may require local electrical inspector approval. All installations must be installed by a licensed electrician and must comply with all national and local codes, laws and regulations. Milbank reserves the right to make changes in specifications and features shown without notice or obligation.



54

100-200 AMP
METER MAIN
PEDESTAL WITH
LOAD CENTER

Meter Main with Load Center Pedestal

100-200 Amp | 4 Terminal | Ringless



U5925-O-200

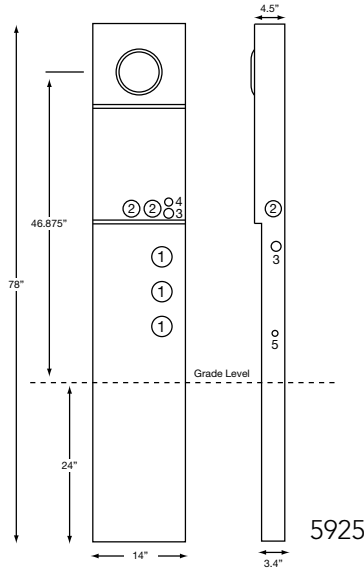

U6220-O-100-10GR

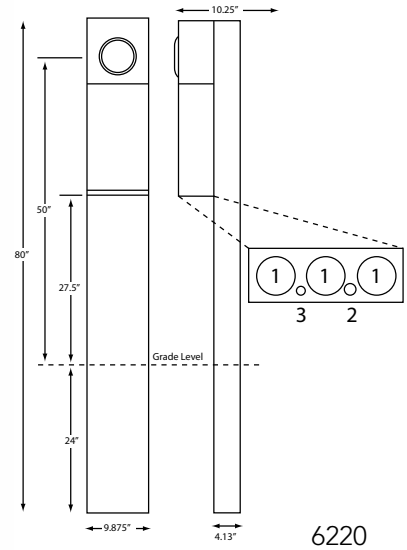

4 Terminal | All-In-One Pedestal | Ringless

Catalog Number	Service	Bypass	Connectors CU/AL		Circuit Provisions	Knockouts				
			Line	Load		1	2	3	4	5
U5925-O-100	UG	None	#6-350	CB	10	2½	2	1	½,¾	¼,½
U5925-O-200	UG	None	#6-350	CB	8	2½	2	1	½,¾	¼,½
U6220-O-100-10GR	UG	None	#6-350	CB	9	2	½	¼	—	—
U6220-O-200-10GR	UG	None	#6-350	CB	7	2	½	¼	—	—

Notes

- **Fifth Terminal:** For field installed fifth terminal, order **K5T**.
- **Interlock Kit:** For generator auxiliary circuit breaker interlock for large frame **QN** with small frame **Q** order **K5815**; for larger frame **QN** with larger frame **QN** order **K5820**; for small frame **Q** with small frame **Q** order **K5830**.
- **Branch Circuit Breakers:** Branch interior accepts most manufacturers' small frame plug-in type circuit breakers (GE, Siemens, Cutler Hammer, Murray).
- **Note:** Ten additional single pole spaces for 100A version and eight additional single pole spaces for 200A version.
- Ring type available. Consult factory

For Horn Bypass use catalog number **U5925**



Please consult serving utility for their requirements prior to ordering or installing, as specifications and approvals vary by utility, and may require local electrical inspector approval. All installations must be installed by a licensed electrician and must comply with all national and local codes, laws and regulations. Milbank reserves the right to make changes in specifications and features shown without notice or obligation.

Meter Main with Load Center Pedestal

100-200 Amp | 4 Terminal | Lever Bypass | Ringless

55
100-200 AMP
METER MAIN
PEDESTAL WITH
LOAD CENTER



U4322-O

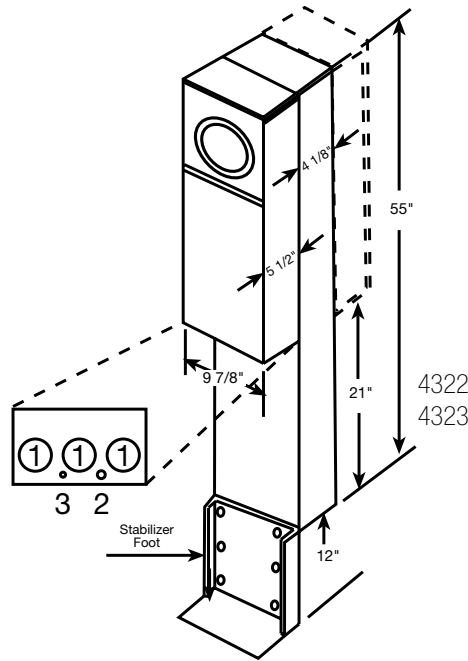

U4323-O

100-200 Amp | 4 Terminal | Meter Main Pedestals | Lever Bypass | Ringless

Catalog Number	Meter Positions	Bypass	Mounting Type	Twin Line Connectors CU/AL		Circuit Provisions	Knockouts		
							1	2	3
U4322-O-(AMP)	Single	Lever	Post	#6-350	#6-350	6	2	1/2	1/4
U4323-O-(AMP)	Double	Lever	Post	#6-350	#6-350	6	2	1/2	1/4

Notes

- **Lever Bypass:** Lever provides clamping action on meter spades and also operates bypass device.
- **Application:** The **U4322 & U4323** pedestals are suitable for use as service equipment or mobile home service equipment. **K5081 / K3188** for direct burial application is included with unit. **K5151** for pad mount application must be ordered as extra.
- **Breakers:** These units are wired as parallel mains and have provisions for six circuits: six single-pole or three double-pole breakers. If main breaker is used, there are provisions for two 2-pole breakers or four 1-pole breakers in series.
- **Fifth Terminal Kit:** For field installed fifth terminal order catalog number **K3865** (neutral wire provided) or **K3866** (no neutral wire).

Please consult serving utility for their requirements prior to ordering or installing, as specifications and approvals vary by utility, and may require local electrical inspector approval. All installations must be installed by a licensed electrician and must comply with all national and local codes, laws and regulations. Milbank reserves the right to make changes in specifications and features shown without notice or obligation.



56

200 AMP
METER MAIN
PEDESTAL WITH
LOAD CENTER

Meter Main with Load Center Pedestal

200 Amp | 4 Terminal | Lever Bypass | Ringless | Jaw Clamping



U5701-O-5T9

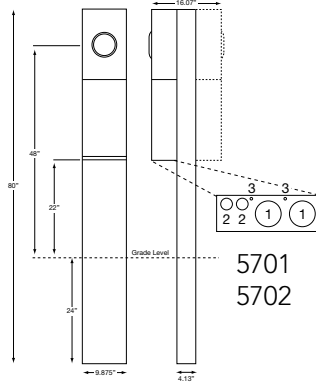

U6221-O-200-10GR

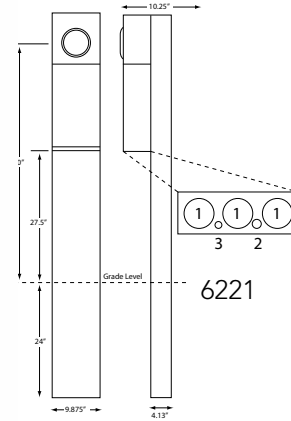

200 Amp | 4 Terminal | Meter Main Pedestal | Lever Bypass | Ringless

Catalog Number	Service	Meter Positions	Bypass	Connectors CU/AL		Circuit Provisions	Knockouts		
				Line	Load		1	2	3
*U5701-O-5T9	UG	Single	Lever	#6-350	CB	4	2	1/2, 3/4	1/4
U5701-O-100S	UG	Single	Lever	#6-350	CB	4	2	1/2, 3/4	1/4
U5701-O-200S	UG	Single	Lever	#6-350	CB	4	2	1/2, 3/4	1/4
*U5702-O-5T9	UG	Double	Lever	#6-350	CB	4	2	1/2, 3/4	1/4
U5702-O-100S	UG	Double	Lever	#6-350	CB	4	2	1/2, 3/4	1/4
U5702-O-200S	UG	Double	Lever	#6-350	CB	4	2	1/2, 3/4	1/4
**U6221-O-100-10GR	UG	Single	Lever	#6-350	CB	10	2	1/2	1/4
**U6221-O-200-10GR	UG	Single	Lever	#6-350	CB	8	2	1/2	1/4

Notes

- **Parallel to Series Conversion:** For the **U5701** and **U5702** without main breakers to field convert from parallel wired to series wired order **K5194**.
 - **Fifth Terminal:** For field installed fifth terminal, order **K3865**.
 - **Stabilizer Foot:** For field installed stabilizer foot, order **K5415**.
 - **Receptacles:** Consult factory for installed receptacle assemblies.
 - **AIC Rating:** All models are rated **22K AIC**.
- *Circuit Breaker not included.
**U6221 with -10GR has 20A GFI receptacle installed from factory.



Please consult serving utility for their requirements prior to ordering or installing, as specifications and approvals vary by utility, and may require local electrical inspector approval. All installations must be installed by a licensed electrician and must comply with all national and local codes, laws and regulations. Milbank reserves the right to make changes in specifications and features shown without notice or obligation.

Metered Pedestals

Receptacles, Circuit Breaker Kits & Accessories

Receptacles & Small Circuit Breaker Accessories

Catalog Number	Description
K5400-BRIDGE-2POS	Self-grounded two-position receptacle bridge with hardware
K5415	Stabilizer foot with hardware
K5T	Fifth terminal for 208Y / 120 volt 3-wire service
K5193	Bus kit to convert series-wired main breaker to parallel
K5194	Wire kit to convert parallel-wired main breaker to series
K5039	Penta bolt utility cover
Z708080-MO	20A duplex GFI receptacle, NEMA type 520
Z701776-MO	30A receptacle, NEMA type TT30R
Z708767-MO	50A receptacle, NEMA type 14-50R
Q120	20A 1P circuit breaker
Q130	30A 1P circuit breaker
Q250	50A 2P circuit breaker
K5935-10GR	Receptacle plate; 10, 10GR configurations
K5935-11GR	Receptacle plate; 11GR configuration
K5935-36GR	Receptacle plate; 36GR, 36GBGR configurations
K5935-41	Receptacle plate; 41, 55, 55GB, 55GBGR configurations
K5935-54	Receptacle plate; 54 configuration
K5935-2/1450	Receptacle plate; 2/1450 configuration
Z819294-SC	U5136, U5701 dead front with opening for two receptacles - MH product
Z1148210	U5136, U5701 dead front with opening for three receptacles

Notes

- Accessories for **U5136, U5137, U5701, & U5702** only.

Please consult serving utility for their requirements prior to ordering or installing, as specifications and approvals vary by utility, and may require local electrical inspector approval. All installations must be installed by a licensed electrician and must comply with all national and local codes, laws and regulations. Milbank reserves the right to make changes in specifications and features shown without notice or obligation.



58

CURBSIDE METER
PEDESTAL

Curbside Meter Pedestal

200 Amp | 4 Terminal | Ringless



S9148-200

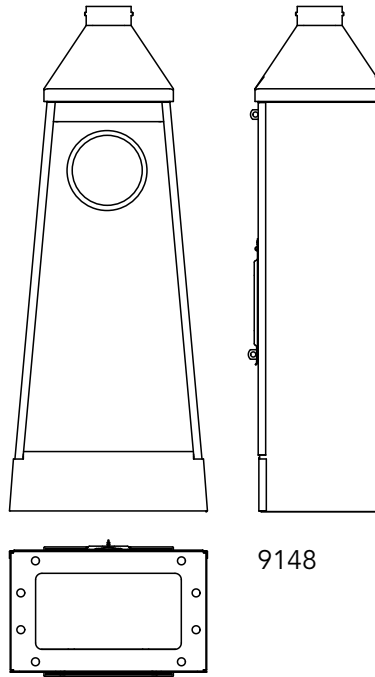

9148

200 Amp | 4 Terminal | Curbside Meter Pedestal | Ringless

Catalog Number	Amp	Terminals	Connectors CU/AL Line and Load	Dimensions		
				D"	W"	H"
S9148-200	200	4	1/0-350 (3)	9½	15¾	33

Notes

- **Post Size:** Accepts 3-inch diameter conduit.
- **Lever Bypass:** Available upon request.



Please consult serving utility for their requirements prior to ordering or installing, as specifications and approvals vary by utility, and may require local electrical inspector approval. All installations must be installed by a licensed electrician and must comply with all national and local codes, laws and regulations. Milbank reserves the right to make changes in specifications and features shown without notice or obligation.

Lever Bypass Residential Pedestal

320 Amp Continuous | 400 Amp Max | 4 Terminal |
Jaw Clamping

59
320 AMP
LEVER BYPASS
RESIDENTIAL
PEDESTAL



U1748-O

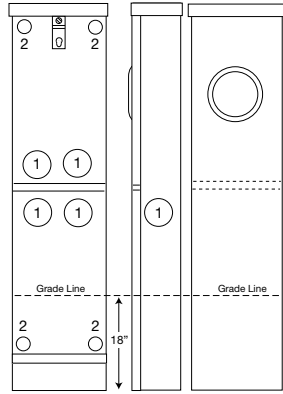

1748

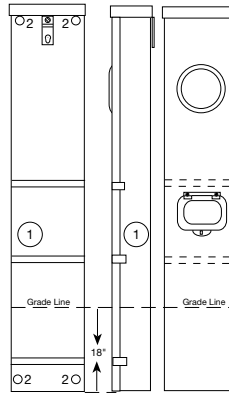

3849



U3849-O-2/200

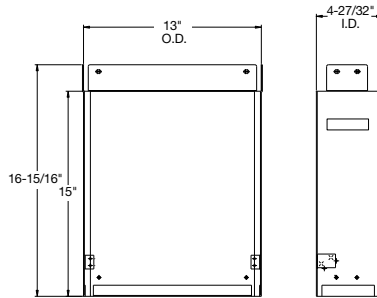

1848

320 Amp | 4 Terminal | Without Breaker | Ringless

Catalog Number	Service	Hub	Bypass	Connectors CU/AL		Dimensions			Knockouts	
				Line	Load	D"	W"	H"	1	2
U1748-O	UG	None	Lever	3/8" x 16 Studs	Twin #6-350	4 7/8	13	64	2 1/2	5/16

Notes

- **Bypass:** The lever supplies clamping action on the meter spade and also operates the bypass device.
- **Fifth Terminal:** For field-installed fifth terminal order kit **K3865**.
- **Pedestal Extension Kit:** If extension kit is required, order as extra kit **S1848**.

320 Amp | 4 Terminal | Meter Main with Breakers | Ringless

Catalog Number	Service	Hub	Bypass	Connectors CU/AL		Dimensions			Knockouts	
				Line	Load	D"	W"	H"	1	2
U3849-O-2/200	UG	None	Lever	3/8" x 16 Studs	CB #1-300 kcmil	4 7/8	13	58	2 1/2	5/16

Notes

- **Breakers:** The **U3849** is furnished with (2) 200 amp Milbank type **UQFBH-200** 22K AIC circuit breakers.
- **Pedestal Extension Unit:** If extension kit is required, order as extra kit **S1848**.
- **Bypass:** The lever supplies clamping action on the meter spade and also operates the bypass device.
- **Fifth Terminal:** For field-installed fifth terminal order kit **K3865**.

Please consult serving utility for their requirements prior to ordering or installing, as specifications and approvals vary by utility, and may require local electrical inspector approval. All installations must be installed by a licensed electrician and must comply with all national and local codes, laws and regulations. Milbank reserves the right to make changes in specifications and features shown without notice or obligation.



Instrument Rated Pedestal

20 Amp | 13 Terminal | With Test Switch Provision

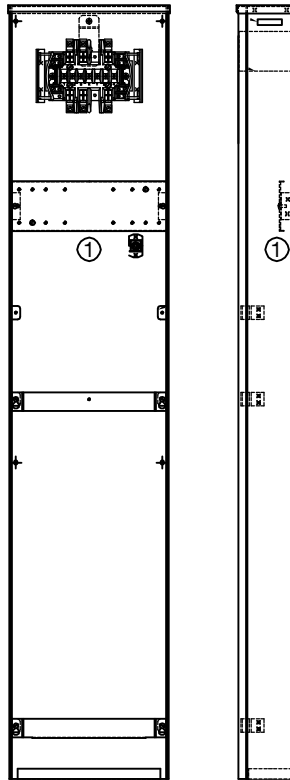

S4084-O

Ringless | Overhead / Underground | with test switch provision*

Catalog Number	Terminals	Hub	Meter Form	Connectors CU	Bypass	Dimensions			Knockouts
						D"	W"	H"	1
S4084-O	13	Blank	6, 8, 9 & (ALT) 10S	#14 - #4 Max	None	4½	12	58	1¼

Notes

- Contact factory for details.

Terminal Box

100, 200 & 400 Amp



U4540-XL

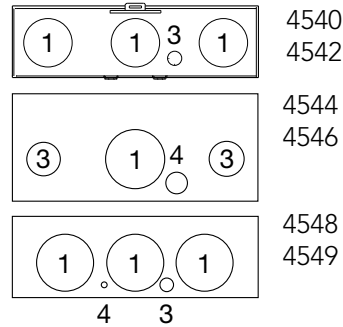
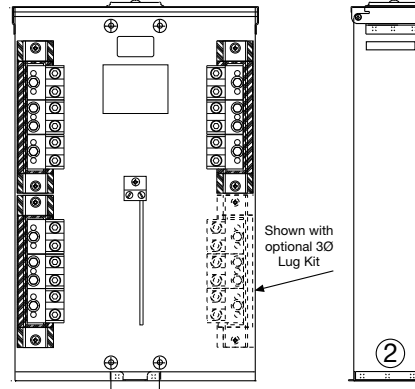

Terminal Boxes | 1Ø and 3Ø | 600 Volt

Catalog Number	Amp	Phase	Hub	Connectors CU/AL	1Ø to 3Ø Kit	Dimensions			Knockouts			
						D"	W"	H"	1	2	3	4
U4544-XL	100	1	C.P.	(6) #12-1/0	K4543	4 $\frac{1}{8}$	9 $\frac{13}{16}$	18	2	1	¼, ½	—
U4546-XL	100	3	C.P.	(6) #12-1/0	N/A	4 $\frac{1}{8}$	9 $\frac{13}{16}$	18	2	1	¼, ½	—
U4540-XL	200	1	C.P.	(6) #6-350	K4539	4 $\frac{1}{8}$	14 $\frac{13}{16}$	23	2½	2½	1¼	¼, ½
U4542-XL	200	3	C.P.	(6) #6-350	N/A	4 $\frac{1}{8}$	14 $\frac{13}{16}$	23	2½	2½	1¼	¼, ½
U4548-RXL	400	1	C.P.	(3) #6-350 or (2) #4-600	K4547	5	15½	27	3	3	¼, ½	¼
U4549-RXL	400	3	C.P.	(3) #6-350 or (2) #4-600	N/A	5	15½	27	3	3	¼, ½	¼

Notes

- **Hub:** Standard hub opening on top with closing plate attached.
- **Features:** UL listed pad lockable Type 3R enclosure.
- **3Ø 120/240V Application:** Field installable 3Ø lug kit converts 1Ø unit to 3Ø unit (consult factory)

Please consult serving utility for their requirements prior to ordering or installing, as specifications and approvals vary by utility, and may require local electrical inspector approval. All installations must be installed by a licensed electrician and must comply with all national and local codes, laws and regulations. Milbank reserves the right to make changes in specifications and features shown without notice or obligation.



Multi-Position Tap Box

Three Phase | Aluminum Construction | Wall or Pad Mountable



Features

- **Painted Aluminum Construction:** Enclosure shells are constructed with lightweight aluminum, making wall-mount installations easier. Powder-coat paint finish helps prevent corrosion.
- **Capable of Wall or Pad Mounting:** Units feature a removable bottom, allowing an easy conversion from a wall-mount to a pad-mount.
- **Smaller Footprint:** The UAP6094 model has a more compact footprint compared with the leading competitor.
- **Multi-port ground lugs**
- **Optional Pentabolt Secured Handle:** Enclosure handle includes a pentabolt locking mechanism (see photos below) for enhanced protection. Does not come standard.



Optional (not standard)

Common Applications



Catalog Number	Phase	Position Lugs	Maximum Wire Size	Maximum Amperage	Dimensions		
					D"	W"	H"
UAP6094-O	3	16	500 kcmil	3000 Amp	16	25 ⁵ / ₈	43
UAP6095-O	3	22	500 kcmil	4000 Amp	16	32 ³ / ₈	43
UAP6096-O	3	14	750 kcmil	3300 Amp	16	25 ¹⁵ / ₁₆	51

Stainless steel pad mount spacing brackets included



Please consult serving utility for their requirements prior to ordering or installing, as specifications and approvals vary by utility, and may require local electrical inspector approval. All installations must be installed by a licensed electrician and must comply with all national and local codes, laws and regulations. Milbank reserves the right to make changes in specifications and features shown without notice or obligation.

Multi-Position Tap Box

Line Drawings

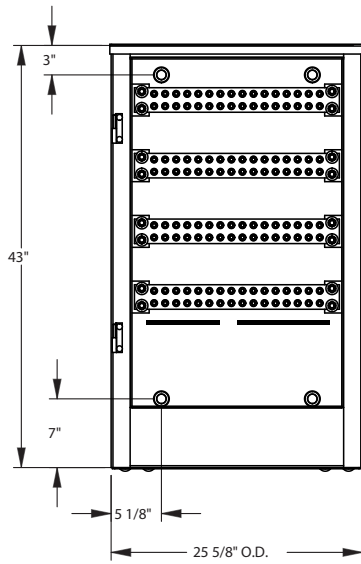

6094

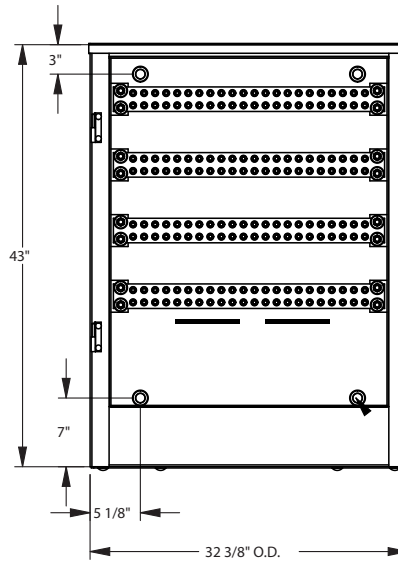

6095

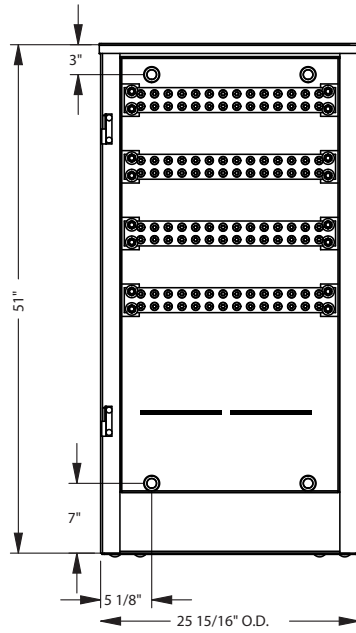

6096

Please consult serving utility for their requirements prior to ordering or installing, as specifications and approvals vary by utility, and may require local electrical inspector approval. All installations must be installed by a licensed electrician and must comply with all national and local codes, laws and regulations. Milbank reserves the right to make changes in specifications and features shown without notice or obligation.



Attractive | Easy to Install | Secure | Cost-Effective

Milbank Commercial Pedestals are pad-mounted, weather resistant electrical enclosures consisting of a utility pull section with optional meter socket, and a customer section containing distribution and control equipment. Milbank Commercial Pedestals are an attractive, secure, easy to install and cost-effective solution when underground remote site power distribution and control equipment is required, replacing unsightly and inefficient strut and backboard structures.



Strut and backboard



Commercial pedestal

UL Listed as Industrial Control Equipment (File E113855)

Standard Features

- Type 3R rain-resistant, vandal-resistant cabinet of polyurethane powder coated steel (aluminum or stainless steel also available)
- UL listed as enclosed industrial control equipment (UL508)
- Isolated lockable and sealable utility metering and lug landing sections
- Lockable customer section for distribution and control equipment with internal deadfront
- Print pocket inside customer section door contains wiring schematics and installation instructions
- Most load centers are UL listed for use with various manufacturers' circuit breakers
- All stainless steel external hardware (screws, bolts, hinges, handles, hasps and sealing screws)

Note
All meter form and bypass options available to meet utility requirements.

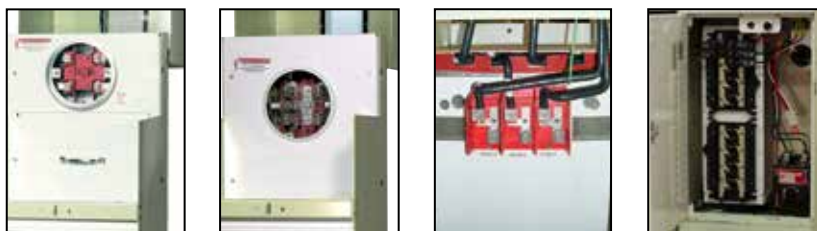

Please consult serving utility for their requirements prior to ordering or installing, as specifications and approvals vary by utility, and may require local electrical inspector approval. All installations must be installed by a licensed electrician and must comply with all national and local codes, laws and regulations. Milbank reserves the right to make changes in specifications and features shown without notice or obligation.

Commercial Pedestals

Attractive | Easy to Install | Secure | Cost-Effective

65
COMMERCIAL
PEDESTALS



Applications

These units are ideal for controlling and metering:

- Traffic signals
- Street lighting
- Power distribution for EV charging stations
- Irrigation and sprinkler systems
- Cell towers and telephone vaults
- Pump stations
- Temporary power for fairgrounds, swap meets, outdoor markets, portable offices, holiday lights, etc.
- Outdoor lighting for athletic fields, tennis and basketball courts, parking lots, landscaping and subdivision entrances, etc.

Available Factory-Installed Options

- Meter sockets: ring type or ringless, up to 400 amp
- Main and branch breakers or T fuses
- Distribution: copper load centers and panel boards
- Clocks, timers and relays
- Photoelectric cells and controls
- Power receptacles: pin and sleeve, twist lock or straight blade
- Contactors: definite purpose, electrical or mechanically held, IEC and mercury types
- Surge protection and lightning arrestors
- Reserve inlet generator receptacle with interlocked circuit breakers
- Motor starters and relays
- Push button controls
- Thermostat controls, fans and heating strips
- Power blocks and terminal blocks
- Steel, aluminum and plywood backboards
- Transformers
- Interlock devices for circuit breakers
- Available in steel, aluminum (raw painted or anodized) or stainless steel construction with powder coated finish available in eight standard colors or special-ordered RAL colors
- Available for applications up to 400 amp, 120V, 208V, 240V, 277V, 480V - 1Ø or 3Ø

Please consult serving utility for their requirements prior to ordering or installing, as specifications and approvals vary by utility, and may require local electrical inspector approval. All installations must be installed by a licensed electrician and must comply with all national and local codes, laws and regulations. Milbank reserves the right to make changes in specifications and features shown without notice or obligation.

Accessories



K3865
Fifth terminal kit for use with ringless meter sockets

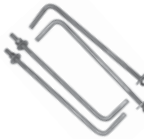

CP-ABK5/8
Anchor bolt kit (includes four 5/8 - 13 x 18" anchor bolts)



105J
Fifth terminal kit for use with ring type meter sockets



CP-TC7D
7-day time clock kit
CP-TC24H
24-hour time clock kit

CP-TCWIRE
Male 4-pin connector and wiring harness for use with time clocks other than above



CP-PE-HOA-3POS
HOA switch for field installation



CP-16PDMNT-CALT
16" pedestal mounting base

CP-24PDMNT-CALT
24" pedestal mounting base (includes mounting hardware)



CP3B "ML" Series

Main Load Center Series

1Ø3 wire 120/240V or 208Y/120V

Application: remote site service for multiple loads

Milbank Main Load Center Commercial Pedestals are designed to handle the vast majority of all requirements in a standard, stocked configuration.

- All units feature a load center with a plug-on, back-fed main breaker.
- Load center has 16 positions for the 100 amp pedestals and 24 circuits for the 200 amp pedestals.
- Both sizes include sub-feed lugs to allow feeding an external panel.

If your application requires turning loads on based on "dusk-to-dawn" requirements, be sure to see the Milbank Switched Load Center Commercial Pedestal products on the following page.

Features

These units include everything required for remote site service:

- NEMA 3R construction.
- Expandable: load centers allow for future expansion without costly modifications.
- All units feature 200 amp meter socket with optional field installable fifth terminal kit available.
- 22K ampere interrupting capacity (AIC) standard.
- Optional mounting base can be embedded in concrete for fast, easy installation.
- Separate sealable and lockable utility termination section.
- Separate sealable and lockable metering section.
- Separate sealable and lockable customer section with a load center for "always on" loads that include a main circuit breaker, 20 (125 or 200 amp model) or 14 (100 amp model) blank breaker spaces and a circuit directory to document configuration.

Note
All meter form and bypass options available to meet utility requirements.



Typical Applications
Remote site service for multiple loads.

Standard Pedestals	Optional Fifth Terminal Kit	Main CB		Load Center Circuits	Meter Socket Type
		Amp	Spaces		
CP3B51115A22	K3865	100	1,2	16	Ringless socket with lever bypass
CP3B52119A22	K3865	200	1,2,3,4	24	Ringless socket with lever bypass

Notes

- Chart shows standard, stocked items. Other options and features are available. Contact factory for options, details and availability.



Please consult serving utility for their requirements prior to ordering or installing, as specifications and approvals vary by utility, and may require local electrical inspector approval. All installations must be installed by a licensed electrician and must comply with all national and local codes, laws and regulations. Milbank reserves the right to make changes in specifications and features shown without notice or obligation.

Commercial Pedestals

Switched Load Center Series | Custom Designs Available

CP3B "SL" Series

Switched Load Center Series
1Ø3 wire 120/240V or 208Y/120V

Note
All meter form and bypass options available to meet utility requirements.

Millbank Switched Load Center Commercial Pedestals are designed not only to provide power for various loads, but also to switch specific loads on and off under certain conditions. A photoelectric cell is used for these controlled loads, and an optional time clock is also available.

Features

These units include everything required for remote site service:

- NEMA 3R construction.
- Expandable: load centers allow for future expansion without costly modifications.
- All units feature 200 amp meter socket with optional field installable fifth terminal kit available.
- 22K amp interrupting capacity (AIC) standard.
- Optional mounting base can be embedded in concrete for fast, easy installation.
- Separate sealable and lockable utility termination section.
- Separate sealable and lockable metering section.
- Separate sealable and lockable customer section with a control circuit including PE receptacle, Lexan® window, glare shield, Hand-Off-Auto (HOA) switch, contractor controlling a 16-circuit load center for controlled loads, a pre-mounted DIN rail and pre-wired connector to add an optional "plug-and-play" time clock kit for PE on and TC off operation and a circuit directory to document configuration.
- A load center for "always on" loads that includes a main circuit breaker, a control power circuit breaker, a switched load center main breaker, nine (125 or 200 amp model) or 11 (100 amp model) blank breaker spaces and a circuit directory to document configuration.



Typical Applications
Traffic signals, parking lots, highways & athletic field lighting

Standard Pedestals	Optional Fifth Terminal Kit	Main CB		Contactor Amperage	Meter Socket Type
		Amp	Spaces		
CP3B51110A22SL1	K3865	100	1,3	60	Ringless socket with lever bypass
CP3B52110A22SL1	K3865	200	1,2,3,4	100	Ringless socket with lever bypass

Notes

- Chart shows standard, stocked items. Other options and features are available. Contact factory for options, details and availability.

Please consult serving utility for their requirements prior to ordering or installing, as specifications and approvals vary by utility, and may require local electrical inspector approval. All installations must be installed by a licensed electrician and must comply with all national and local codes, laws and regulations. Milbank reserves the right to make changes in specifications and features shown without notice or obligation.



Commercial Pedestals

CP3B "400" 400 Amp Series



Milbank 400 Amp Commercial Pedestals are designed to provide a weather and vandal resistant metered enclosure for various loads and distribution. Each pedestal has been designed to handle a wide range of applications using standard, stocked configurations.

- Choice of a single main breaker or twin service disconnect breakers gives flexibility to the pedestal design.
- Optional distribution with feed-through lugs below the service disconnect breakers allows the pedestal to handle numerous applications.
- Typical applications include remote homes where the metering is best located at the curb side or other remote area. The pedestal can also provide power to secondary residence, on-site business, workshop, irrigation, lighting, security or other secondary load.
- Available in custom colors to match home or landscaping.

Features

These units include everything required for remote service:

- Type 3R construction
- Main circuit breaker or dual service disconnects
- Expandable: load center units allow for future expansion without costly modifications
- Optional mounting base can be embedded in concrete for fast, easy installation
- Separate sealable and lockable utility termination section with lug termination
- Separate sealable and lockable metering section
- A separate sealable and lockable customer section with a circuit directory and a print pocket to hold all documentation
- Meter socket options include ring type with bypass studs, ringless with heavy duty lever bypass, or K-Type bolt-on

Typical Applications

Remote site service for residential and commercial job sites.

Standard Pedestals	Optional fifth Terminal Kit	Main CB	Load Center Circuits	Meter Socket Type
CP3B54120B22	K3865	2-200 amp	(2) 12 circuit	Ringless with lever bypass
CP3B5411JB22	K3865	320 amp (400 max)	0	Ringless with lever bypass

Notes

- Chart shows standard, stocked items. Other options and features are available. Contact factory for options, details and availability.
- Stud utility landing is standard. Lug kits are available from factory.
- Units with load centers have (2) #6-250 sub-feed lugs on each load center. (Each load center is 200 amp rated and UL listed with: Siemens, General Electric and Cutler-Hammer plug-in style circuit breakers.)



Please consult serving utility for their requirements prior to ordering or installing, as specifications and approvals vary by utility, and may require local electrical inspector approval. All installations must be installed by a licensed electrician and must comply with all national and local codes, laws and regulations. Milbank reserves the right to make changes in specifications and features shown without notice or obligation.

Commercial Pedestals

CP3B "IR" Irrigation Control Series



Milbank "IR" Series Irrigation Pedestals install quickly and simply – often in less than an hour with a single technician – a fraction of the time typically needed for strut farm and other installation set ups. Additionally, the pedestal comes pre-wired, so the technician simply drops in the pre-drilled concrete box pad, fastens the pedestal and runs the wires. Prewired landing lugs are provided in a separate utility side so that there is no more need to wrestle with hard-to-bend wires. Simply run the utility wire up and land on the lugs. With both the motor starter and disconnect in the same enclosure, all the controls are housed in a safe, lockable pedestal that protects against vandalism and energy theft.

Features

- 3Ø4W, 480Y/277 volt
- One technician can install in under an hour with use of Milbank's pre-drilled box pad
- All units are UL listed and service entrance rated
- Fused disconnect with accessible handle through the deadfront
- HOA and push button start
- Separate accessible utility side with pre-wired landing lugs
- NEMA rated starters (sizes 1-5)
- Soft start units sizes 30HP-150HP
- 30 amp fuse block for pivot pre-wired in the unit
- White powder coated paint finish helps keep components cooler
- Options include:
 - Hour meter
 - Chemical injection receptacle
 - Multiple injection receptacle
 - Multiple 30 amp fuse blocks possible

Typical Applications

Power pedestal for irrigation systems or other pump control applications.

Standard Pedestals	Exterior Cabinet	NEMA Rating
CP3B0281UMWIR04	White	4
CP3B0281UMWIR03	White	3
CP3B0181UMWIR02	White	2

Notes

- Chart shows standard, stocked items. Other options and features are available. Contact factory for options, details and availability.

Please consult serving utility for their requirements prior to ordering or installing, as specifications and approvals vary by utility, and may require local electrical inspector approval. All installations must be installed by a licensed electrician and must comply with all national and local codes, laws and regulations. Milbank reserves the right to make changes in specifications and features shown without notice or obligation.



Commercial Pedestals

CP3B "BBS" Battery Backup Series



Milbank BBS Series Commercial Pedestals are designed to provide battery backup power for various loads, and to switch specific loads on and off under certain conditions; a photoelectric cell or time clock to control lighting circuits, as an example. Metered and unmetered power distribution options are available. The back-up power pedestal is designed to handle the vast majority of today's back-up power requirements. By using 19" rack design, shelves can be adjusted to accommodate the required batteries and manufactures DC to AC inverters, transfer switches and other related equipment. This design gives the user a wide range of design and configuration options. Complete turnkey, ready to power-up pedestals are offered along with basic units ready to accept batteries and inverters supplied by others.

Features

- Type 3R construction
- 100 through 320 amp meter socket with the option of either a ring type socket (conforms to EUSERC 308) with or without test/bypass blocks or a heavy duty ringless socket with lever bypass
- Separate sealable utility termination compartment
- An isolated separate customer section with service disconnects, power distribution options and power control
- 19" wide rack in customer compartment for easy layout of equipment
- Battery trays
- Thermostat with cooling fan
- Filtered louvers for heat rise flow through ventilation
- Three point door latch (key or pad lockable)

Typical Applications

Metered emergency uninterrupted power for traffic intersections, wireless, phone and communications equipment, parking lots, camera and security locations.

Options

- Manual bypass switch
- Transfer switch for generator power back-up
- Generator inlet receptacles 30 amp through 200 amp
- Pad lockable provision for receptacles
- Police access door
- Metered load center distribution
- Unmetered load center distribution
- Photo electric controls (for street lighting)
- Time clocks
- HOA switches
- Contactors
- GFI duplex receptacles
- Thermostat for heating control
- Heating pads or elements
- Roll out shelves for batteries
- Surge arrestors and lighting arrestors



Please consult serving utility for their requirements prior to ordering or installing, as specifications and approvals vary by utility, and may require local electrical inspector approval. All installations must be installed by a licensed electrician and must comply with all national and local codes, laws and regulations. Milbank reserves the right to make changes in specifications and features shown without notice or obligation.

Commercial Pedestals

CP3B "Power Transfer" Series



Milbank Power Transfer Series Pedestals provide unmetered AC power, distribution, surge suppression, mechanical interlock and stand-by generator receptacle all in a neat, compact pedestal.

Features

- 120/240V 1Ø3W through 277/480V 3Ø4W ratings
- Metered or unmetered units
- Choice of EUSERC ring type or ringless meter sockets
- 60 amp through 400 amp ratings
- UL listed Type 3R rated
- Pad lockable, isolated utility compartments
- 20 amp GFI convenience receptacle
- Lockable recessed generator receptacle door
- Utility and generator indicator light options
- All stainless steel hardware
- Galvanized steel, aluminum or stainless steel cabinet options
- Custom designs available



Typical Applications

Traffic intersections, cell sites, cable TV, pump and lift stations requiring utility power with backup generator power

Please consult serving utility for their requirements prior to ordering or installing, as specifications and approvals vary by utility, and may require local electrical inspector approval. All installations must be installed by a licensed electrician and must comply with all national and local codes, laws and regulations. Milbank reserves the right to make changes in specifications and features shown without notice or obligation.



Commercial Pedestals

CP3BB "CT Metered" Series



Milbank CT Metered Series Commercial Pedestals are designed to be used where a smaller service package would be a better choice over large 3R rated combination switchboards. These pedestals have amperage ratings of 400 to 800 amp at voltages up through 480 volt three phase.

Features

- UL listed, freestanding Type 3R service
- A low profile CT pedestal
- All utility equipment is isolated in separated pad lockable and sealable compartments
- Separate customer compartment designed to hold distribution and control equipment
- Dead front customer construction
- Optional mounting base
- Optional construction in steel, aluminum and stainless steel.
- Wide choice of powder paint colors

Typical Applications

Large homes, pumping and lift stations, motor control, water treatment plants, EV charging stations, commercial buildings, large remote service requirements, commercial and industrial control systems.



Please consult serving utility for their requirements prior to ordering or installing, as specifications and approvals vary by utility, and may require local electrical inspector approval. All installations must be installed by a licensed electrician and must comply with all national and local codes, laws and regulations. Milbank reserves the right to make changes in specifications and features shown without notice or obligation.

Commercial Pedestals

CP3A "Slimline" Series



Milbank Slimline Series Commercial Pedestals provide a sleeker, smaller footprint, with wireway access on the side of the unit rather than the back, allowing maximum flexibility to place the pedestal in tighter spaces.

Features

- UL listed as service equipment
- 100 or 200 amp
- Vandal-resistant, secure and attractive design
- Customer compartment with distribution and control equipment with swing dead front door, secured with both a hasp/latch and draw latch outer door
- Utility metering compartment protected with a hinged hood, increasing resistance to meter vandalism
- Small footprint
- Wireway located on left side of pedestal for utility incoming wire, allowing pedestal to be mounted with back very close to a wall (14")
- Available in 12" and 20" widths and 50" and 63" (metered) and 43" (unmetered) heights
- Includes a print pocket for plans and drawings
- 200 amp main available
- Voltage range: 120V–480V
- Compatible with both ringless and ring type meter sockets, 4–7 terminals
- Available in a wide array of colors, including but not limited too all ANSI powder coated paint colors upon request
- Pedestal mounting base option saves time and labor to install on a cement pad—no anchor bolts required
- Powder coated G90 galvanized steel, raw, anodized or powder coated aluminum and stainless steel exterior options

"Slimline" Series Direct Bury Extension

- No need for concrete
- Bolts directly to unit
- Easy, modular design
- Ships in a smaller package
- Increases project flexibility
- Easier to handle and install
- Utilizes stabilizer feet to prevent leaning over time
- Pedestal and extension can be installed within 45 minutes

Notes

- 14 guage steel
- Only available for 12" pedestals

Typical Applications

Roadway lighting and signage, wastewater treatment facilities, parks and landscaping, and any application where physical space is at a premium



Please consult serving utility for their requirements prior to ordering or installing, as specifications and approvals vary by utility, and may require local electrical inspector approval. All installations must be installed by a licensed electrician and must comply with all national and local codes, laws and regulations. Milbank reserves the right to make changes in specifications and features shown without notice or obligation.





UQFP
UQFPH



UQFP-M
UQFPH-M



UQFB-X1



UQFB-X



UQFB

200 Amp Frame | Plug-In | 10,000 AIC & 22,000 AIC | Two-Pole - Common Trip

Amp	10K AIC Plug-In	22K AIC Plug-In	10K AIC Plug-In	22K AIC Plug-In	Wire Range	
					CU	AL
100	UQFP-100	UQFPH-100	UQFP-M-100	UQFPH-M-100	#3-#1	#1-1/0
125	UQFP-125	UQFPH-125	UQFP-M-125	UQFPH-M-125	#3-#1	#1-1/0
150	UQFP-150	UQFPH-150	UQFP-M-150	UQFPH-M-150	1/0-300	2/0-300
175	UQFP-175	UQFPH-175	UQFP-M-175	UQFPH-M-175	1/0-300	2/0-300
200	UQFP-200	UQFPH-200	UQFP-M-200	UQFPH-M-200	1/0-300	2/0-300

200 Amp Frame | Bolt-On | 10,000 AIC & 22,000 AIC | Two-Pole - Common Trip

Amp	10K AIC Bolt-On	22K AIC Bolt-On	10K AIC Bolt-On	22K AIC Bolt-On	Wire Range	
					CU	AL
100	UQFB-100	UQFBH-100	UQFB-100-X1	UQFBH-M-100	#3-#1	#1-1/0
125	UQFB-125	UQFBH-125	UQFB-125-X1	UQFBH-M-125	#3-#1	#1-1/0
150	UQFB-150	UQFBH-150	UQFB-150-X1	UQFBH-M-150	1/0-300	2/0-300
175	UQFB-175	UQFBH-175	UQFB-175-X1	UQFBH-M-175	1/0-300	2/0-300
200	UQFB-200	UQFBH-200	UQFB-200-X1	UQFBH-M-200	1/0-300	2/0-300

Notes

- **UL listed:** For use with 60°C or 75°C wire.
- **UQFP:** For parallel main circuit breaker applications.
- **UQFP-M:** For series main circuit breaker applications Split load tab features allow for feed-through capability.
- **UQFB:** (2) 1/0-300 lugs provided on load and line side (cable-in, cable-out).
- **UQFB3:** Three-pole available. Consult factory.
- **UQFB-X:** (2) 1/0-300 lugs provided on load side and (2) line bar bus connections on line side.
- **UQFB-M:** For series main circuit breaker applications. Split load tab features allow for feed-through capability.
- **UQFB-X-MOD:** Replacement circuit breaker with line barriers removed.



Please consult serving utility for their requirements prior to ordering or installing, as specifications and approvals vary by utility, and may require local electrical inspector approval. All installations must be installed by a licensed electrician and must comply with all national and local codes, laws and regulations. Milbank reserves the right to make changes in specifications and features shown without notice or obligation.

Accessories

Hubs and Closing Plates

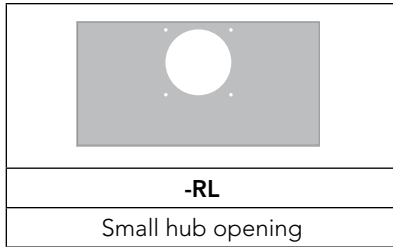

-WL A7514	-YL A7515	-ZL A7516	-DL A7517	-EL A7518	-XL A7551
1" hub	1¼" hub	1½" hub	2" hub	2½" hub	Small closing plate

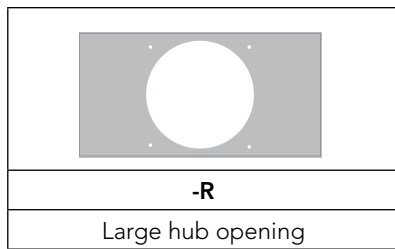

-F A8110	-G A8111	H A8112	-X A9064	-RRL S8324
3" hub	3½" hub	4" hub	Large closing plate	Large hub opening adapted to small hub opening

Please consult serving utility for their requirements prior to ordering or installing, as specifications and approvals vary by utility, and may require local electrical inspector approval. All installations must be installed by a licensed electrician and must comply with all national and local codes, laws and regulations. Milbank reserves the right to make changes in specifications and features shown without notice or obligation.



Connector Kits, Closing Kits and Sealing Rings

Connector Kits | For Use with 3/8"-16 Stud Type Units Only

Single			Twin		
Suffix	Part #	(3 per set) - 1Ø	Suffix	Part #	(3 per set) - 1Ø
K1	K1539	6-350	K2	K1350	6-350
K3	K1540	4-600 or (2) 1/0-250	K2L	K1350L	6-350 (non rotating)
K3L	K1540L	4-600 or (2) 1/0-250 (non rotating)	K4	K1541	4-600
Suffix	Part #	(4 per set) - 3Ø	Suffix	Part #	(4 per set) - 3Ø
K5	K3082	6-350	K6	K3442	6-350
K7	K3441	4-600 or (2) 1/0-250	K8	K3083	4-600

Bypass Link



K8180 (sold in pairs)

Closing Covers

Meter Closing Plate (Ring Type / Ringless)	Metal Closing Plate (For Ringless Sockets)
6003 - Grey Plastic	CP-21
6116 - Clear Plastic	
6002 - Clear/Bladed	Meter Closing Plate

Generator Interlock

K5815 - large QN with small frame Q
K5820 - large frame QN with large frame QN
K5830 - small frame Q to small frame Q

Sealing Rings

MR-2 - Snap Action	MR-4 - Screw Type (Stainless Steel)
MR2-SS - Stainless Steel	

Touch-Up Paint







A-GP - Light Grey

Accessories

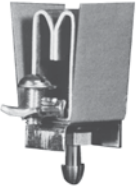
Fifth Terminal and Tap Connectors

Fifth Terminal

			
5T8K2 - 100-200 amp "Plug-In"	K5T - 200 amp (Block with Square Hole)	K3865 - Heavy Duty Jaw Clamping (K3866 without Neutral Wire)	This is for Condo meter- ing Banks (125-200 amp) K2381

Isolated Neutral Kit



Anti-Inversion Clip

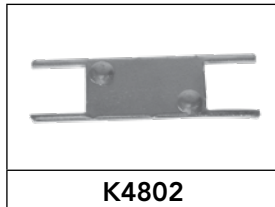

Disconnect Sleeve



Triplex Ground



*Isolated neutrals are specific to the meter socket. Consult factory for correct isolated neutral.

*Disconnect sleeves not to be used with lever bypass sockets.

Please consult serving utility for their requirements prior to ordering or installing, as specifications and approvals vary by utility, and may require local electrical inspector approval. All installations must be installed by a licensed electrician and must comply with all national and local codes, laws and regulations. Milbank reserves the right to make changes in specifications and features shown without notice or obligation.



Tap Connectors & Block Assemblies

Tap Connectors (3 per set)

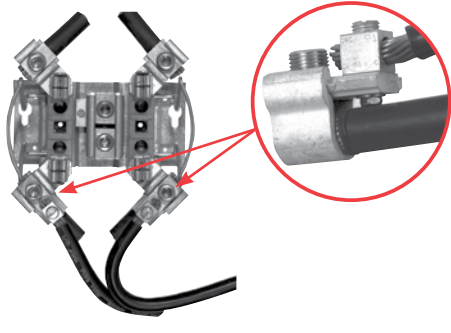

Replaces the load or line side slide-in nut assembly on Milbank 200 amp sockets. Allows for a 100 amp tap location in addition to the #6-350 kcmil load-side connector. **K5022** includes safety barrier extensions for applications over 300 VAC. Three lugs per kit.

K4977-INT - Internal Hex
K4977-EXT - External Hex
K5022-INT - Internal Hex (set of 4 w/ barrier)

Pedestal Extension Units

Catalog Number	D"	W"	H"
S8988	4½	8¾	15
S3488	6	11	15
S2571	4⅞	10	12
S1848	4⅞	13	15
K4694	6	9	24
K5800	4⅞	9	15

100 Amp Blocks *(single sockets only)*



BL7474 - Block Assembly
BL7499 - Horn Bypass Block Assembly
Z904486-AO - Slotted Nut Assembly
Z903274-AO - Horn Bypass Nut Assembly
Z802965-AC - Neutral without Nut
Z901925-AC - Hex Nut Set Screw

200 Amp Blocks *(single sockets only)*



K4527 - Internal Hex Block Assembly (w/ meter support)
K4528 - External Hex Block Assembly (w/ meter support)
K4529 - Internal Hex Horn Bypass Block Assembly (w/ meter support)
K4530 - External Hex Horn Bypass Block Assembly (w/ meter support)
Z916265-AO - Internal Nut Assembly
Z916264-AO - External Nut Assembly
Z814898-AC - Neutral without Nut



Please consult serving utility for their requirements prior to ordering or installing, as specifications and approvals vary by utility, and may require local electrical inspector approval. All installations must be installed by a licensed electrician and must comply with all national and local codes, laws and regulations. Milbank reserves the right to make changes in specifications and features shown without notice or obligation.

NEMA Commercial Enclosures

Strong & Secure | Powder Coated | NEMA Rated

79
NEMA
COMMERCIAL
ENCLOSURES

NEMA Commercial Enclosures

Milbank's line of commercial enclosures includes the full gamut of styles and sizes; everything from junction boxes to transformer cabinets, telephone cabinets to wireway.

Type 1 Enclosures

Milbank's Type 1 enclosures are designed for indoor use to provide a degree of protection to personnel against access to hazardous parts and to provide a degree of protection of the equipment inside the enclosure against ingress of solid foreign objects, such as falling dirt.



Type 3R Enclosures

Milbank's Type 3R enclosures are designed for either indoor or outdoor use to provide a degree of protection from harmful effects on the equipment due to the ingress of water (rain, sleet, snow) and that will be undamaged by the external formation of ice on the enclosure.

Type 1 and 3R Wireway

Milbank's wide range of wireway is available in many styles and sizes and its wide range of fittings allows it to smoothly transition to and from competitors' products.



Please consult serving utility for their requirements prior to ordering or installing, as specifications and approvals vary by utility, and may require local electrical inspector approval. All installations must be installed by a licensed electrician and must comply with all national and local codes, laws and regulations. Milbank reserves the right to make changes in specifications and features shown without notice or obligation.



MAXIMUM NUMBER OF CONDUCTORS IN CONDUIT

Table from 2008 NEC Code Reference: Rigid Metal Conduit

Type	Conductor Size (AWG/kcmil)	Conduit Trade Sizes (Inches)									
		½	¾	1	1¼	1½	2	2½	3	3½	4
THHN, THWN, THWN-2	12	9	16	26	46	62	102	146	225	301	387
	10	6	10	17	29	39	64	92	142	189	244
	8	3	6	9	16	22	37	53	82	109	140
	6	2	4	4	12	16	27	38	59	79	101
	4	1	2	4	7	10	16	23	36	48	62
	3	1	1	3	6	8	14	20	31	41	53
	2	1	1	3	5	7	11	19	26	34	44
	1	1	1	1	4	5	8	12	19	25	35
	1/0	1	1	1	3	4	7	10	16	21	27
	2/0	0	1	1	2	3	6	8	13	18	23
3/0	0	1	1	1	3	5	7	11	15	19	
4/0	0	1	1	1	2	4	6	9	12	16	
XHH, XHHW, XHHW-2	4	1	2	4	7	10	16	24	37	49	63
	2	1	1	3	5	7	12	17	26	35	45
	1/0	1	1	1	3	4	7	10	16	22	28
	2/0	0	1	1	2	3	6	9	13	18	23
	4/0	0	1	1	1	2	4	6	9	12	16
	250	0	0	1	1	1	3	5	7	10	13
	350	0	0	1	1	1	2	3	6	7	10
500	0	0	0	1	1	1	2	4	5	7	
750	0	0	0	0	1	1	1	3	4	5	

This table is for concentric stranded conductors only. For cables with compact conductors refer to NEC. Refer to latest NEC Code or Local Codes for updated requirements.

SAMPLE RATING LABEL

CATALOG NUMBERS U5952 & U5953
100A MAXIMUM, 120/240 VAC SINGLE PHASE, THREE WIRE
RAINFOOD NEMA TYPE 3R

SHORT CIRCUIT CURRENT RATING IS 10,000 RMS SYMMETRICAL AMPERE AT 240 VAC MAXIMUM, BUT IS LIMITED TO THE LOWEST SHORT CIRCUIT CURRENT RATING OF ANY INSTALLED CIRCUIT BREAKER. WATTHOUR METER NOT INCLUDED IN SHORT CIRCUIT CURRENT RATING. REPLACEMENT CIRCUIT BREAKER MUST BE THE SAME TYPE AND RATING. USE SIEMENS QP QT CUTLER-HAMMER QP, BD, BR; SQUARE D HOMELINE, G.E. TQ, THQ, THQL

SUITABLE FOR USE AS RECREATIONAL VEHICLE SITE SUPPLY EQUIPMENT

UNDERGROUND FEED ONLY

ON TRIP OFF

TO RESET BREAKER MOVE TO "OFF" THEN TO "ON"

DANGER
HAZARD OF ELECTRICAL SHOCK OR BURN
TURN OFF POWER
SUPPLYING THIS EQUIPMENT BEFORE WORKING INSIDE

WIRE TERMINAL INFORMATION USE AL-CU CONDUCTORS			SHIPPING TENDS TO LOOSEN BOLTED CONNECTIONS. CHECK AND TIGHTEN ALL HARDWARE BEFORE ENERGIZING UNIT
TERMINAL	WIRE RANGE	TORQUE LB-IN	
LINE AND LINE NEUTRAL	350 KCMIL - #6	250	SIZE OF FIELD INSTALLED CONDUCTORS SHALL BE 60° OR 75° C SIZED TO 60° C RATING FOR 110 AMPS OR LESS AND 75° C SIZED TO 75° C FOR 125 AMPS AND ABOVE
GROUND CONNECTOR	2/0 AWG - #14 AWG	120	
LOAD NEUTRAL SLOTTED HEAD (LARGE HOLE)	14 - 10	35	
	8	40	
	6 - 4	45	
LOAD NEUTRAL SLOTTED HEAD (SMALL HOLE)	3 - 1/0	50	
	14 - 10	20	
	8	25	
	6	35	

* ALLOWABLE AMPACITIES OF INSULATED COPPER & ** ALUMINUM CONDUCTORS (3W IN CONDUIT) 75°C (167°F)

*CU		AL or **Cu-Clad AL	
A	B	A	C
18	-	-	-
16	-	-	-
14	20†	-	-
12	25†	12	20†
10	35†	10	30†
8	50	8	40
6	65	6	50
4	85	4	65
3	100	3	75
2	115	2	90
1	130	1	100
1/0	150	1/0	120
2/0	175	2/0	135
3/0	200	3/0	155
4/0	230	4/0	180
250	255	250	205
300	285	300	230
350	310	350	250
400	335	400	270
500	380	500	310
600	420	600	340
700	460	700	375
750	475	750	385

A = Size: AWG/MCM
*B = Ampere Rating for Insulation Types:
FEPW, RH, RHW, THW, THWN, XHHW, USE, 2W.
**C = Ampere Rating for Insulation Types:
RH, RHW, THW, THWN, XHHW, USE
(Per NEC table 310-16)

AMPACITY CORRECTION FACTORS

AMBIENT TEMP.°C*	CORRECTION FACTOR	AMBIENT TEMP.°F*
21 - 25	1.05	70 - 77
26 - 30	1.00	78 - 86
31 - 35	.94	87 - 95
36 - 40	.88	96 - 104
41 - 45	.82	105 - 113
46 - 50	.75	114 - 122
51 - 55	.67	123 - 131
56 - 60	.58	132 - 140
61 - 65	.33	141 - 158

Overall ampere ratings of U/L listed Milbank multiple position meter sockets are based on **2008 N.E.C. Handbook Article 220-84** and **ANSI / UL-414** (except where restricted by line connector size.) These requirements provide for a diversity factor / demand factor being utilized in determining the overall (main bus / lug) rating of a gang socket. All Milbank U/L listed gang sockets meet or exceed these diversity factor/demand factor requirements. Standard overall ampacity ratings for U/L listed and non U/L listed gang sockets are as shown in the chart below. Ampere ratings of meter sockets are based on the meter socket being wired with 75° C insulated wire conductor, sized in accordance with **Table 310-16 of the National Electric Code.**

GANG SOCKET OVERALL AMPACITIES

NO. OF METER POSITIONS	100A / POS. AMPACITY	125A / POS. AMPACITY	150A / POS. AMPACITY	200A / POS. AMPACITY
2	200A	200A	200A	200A #
3	200A	225A	225A	270A
4	200A	250A	270A	360A
5	225A	285A	338A	450A
6	270A	330A	396A	528A

† Unless otherwise permitted elsewhere in the Code, the overcurrent protection for conductor types marked with an obelisk (†) shall not exceed 15 amps for 14 AWG, 20 amps for 12 AWG, and 30 amps for 10 AWG copper; or 15 amps for 12 AWG and 25 amps for 10 AWG aluminum and copper-clad aluminum after any correction factors for ambient temperature and number of conductors have been applied.

Some constructions are rated at 400 amps overall. Contact your sales representative for more information. Refer to latest NEC Code or Local Codes for updated requirements.



Please consult serving utility for their requirements prior to ordering or installing, as specifications and approvals vary by utility, and may require local electrical inspector approval. All installations must be installed by a licensed electrician and must comply with all national and local codes, laws and regulations. Milbank reserves the right to make changes in specifications and features shown without notice or obligation.

Energization of Electrical Equipment

Important Information for Installers

Important Note

In addition to national and local electrical codes, many utilities have specific requirements for metering equipment. Always consult the serving utility for their specifications and requirements prior to ordering or installing Milbank meter mounting equipment.

Before Energizing

1. Give equipment a thorough visual examination to determine that:
 - a) No shipping or installation damage exists.
 - b) Proper clearances have been maintained.
 - c) All connections have been made.
 - d) Equipment is clean and dry.
2. Make a thorough examination to:
 - a) Verify tightness of all bolted connections (see table below).
 - b) Manually operate all circuit breakers, switches, relays, etc.
 - c) Check rigidity of all mountings, bus bars and components.
 - d) Use test equipment to check continuity of circuitry and integrity of insulation.
3. All switches and circuit breakers should be in the OFF position.
4. Verify that manual meter bypass (if applicable) is in non-bypass position.
5. Install cover and/or close doors.
6. If installation is not being energized at this time, follow "after-energizing" steps listed below. These steps will secure the installation in case of accidental energization.

When Energizing

1. Use caution and follow established safety procedures:
 - a) Wear safety apparel.
 - b) Use safety equipment.
 - c) Take action to prevent injury to yourself and others in the event of failure of the installation.
 - d) Take action to prevent/decrease damage to property in the event of failure of the installation.
 - e) If you are unsure how to safely energize the installation, get someone who is knowledgeable to do it.

After Energizing

1. Secure the installation:
 - a) To prevent accidental contact with energized parts, cover all openings with approved filler devices.
 - b) To prevent unauthorized access, secure all covers and/or doors with approved security devices.
 - c) Attach/post information to advise others of potential hazards associated with the installation.

Recommended Torque for General Applications*

Nominal Size	Joint Description		Head Type	Torque (Inch Lbs.)
	Screw	Nut		
10	Brass	Brass Nut or Extruded Hole	All	20-25 inch lbs.
10	Steel	Copper or Aluminum Busbar $\leq 1/8"$	All	25-30 inch lbs.
10	Steel	Steel Nut or Extruded Hole; CU or AL Busbar $> 1/8"$	All	30-35 inch lbs.
12	Steel	Aluminum Extruded Hole	All	30-35 inch lbs.
12	Steel	Steel Nut or Extruded Hole	All	40-50 inch lbs.
1/4	Steel	Aluminum Extruded Hole	All	40-50 inch lbs.
1/4	Steel	Steel Nut or Extruded Hole; CU or AL Busbar	All	50-60 inch lbs.
5/16	Steel	Aluminum Extruded Hole	Hex	60-70 inch lbs.
5/16	Steel	Steel Nut or Extruded Hole; CU or AL Busbar	Hex	100-150 inch lbs.
3/8	Steel	Steel Nut	Hex	150-200 inch lbs.
1/2	Steel	Steel Nut	Hex	200-250 inch lbs.

* Interior labels typically indicate the required torque for wire connectors and studs, and should be referenced first.
CU: Copper
AL: Aluminum

Please consult serving utility for their requirements prior to ordering or installing, as specifications and approvals vary by utility, and may require local electrical inspector approval. All installations must be installed by a licensed electrician and must comply with all national and local codes, laws and regulations. Milbank reserves the right to make changes in specifications and features shown without notice or obligation.



Materials

Steel Quality

The meter equipment listed in this catalog is made of galvanized steel (AISI* G90) to afford the best possible weather proofing.
*American Iron and Steel Institute.

Steel Sheet

16 gauge, galvanized, sheet: 1 1/4 oz./ sq.ft. class zinc-coated. (AISI G90)
14 gauge, galvanized, sheet: 1 1/4 oz./ sq.ft. class zinc-coated.

Aluminum Extrusion

Wire-Terminal: Alloy; 6061-T6, Tin-plated for CU/AL wire.
Bus Bar: Alloy; 6101-O & 6063-O

Aluminum Sheet

3000 series aluminum sheet, H14, or 5052 series aluminum sheet, H32. Where applicable thicknesses range from .064-.125

Copper Sheet & Bus

Electrolytic copper with tin plating in most applications.

Insulating Materials

- In most units, support bases for current-carrying components are molded from fiberglass reinforced high-strength, track resistant, thermoset polyester molding compounds.
- Clear or black safety shields and polarity barriers are molded from high-strength, track resistant, polycarbonate molding compounds.
- Various sheet insulating materials, as appropriate for the application are utilized in the fabrication of flat, formed and punched component parts and barriers.

Finish

Process

Light gray state-of-the-art electrostatically applied powder paint offers a durable, non-fading finish. For further information concerning the chemical analysis of the weather resistant finish, please contact the factory.

Metal Fastners

Zinc-coated with a chromate dip.

Ratings & Compliance

Ratings & Compliance

All Milbank electrical enclosures in this catalog are rated "Type 3R Enclosure" unless specified otherwise on the product's page. All enclosures with a UL designation are constructed per the appropriate UL Standard and may be installed per the National Electric Code. UL procedure files associated with the UL Standards are listed as follows: Meter Sockets (UL 414, File E30202), Test Switches (UL 414, File E62531), Power Outlets (UL 231, File E90945), Panelboards (UL 67, File E32628) and Pullout Switches (UL 1429, File E133062). Additional standards are utilized as applicable: Meter Sockets (ANSI C12.7), Test Switches (ANSI C12.9) and Panelboards (NEMA PB-1).



Please consult serving utility for their requirements prior to ordering or installing, as specifications and approvals vary by utility, and may require local electrical inspector approval. All installations must be installed by a licensed electrician and must comply with all national and local codes, laws and regulations. Milbank reserves the right to make changes in specifications and features shown without notice or obligation.

Meter Forms

Reference Information

DIAGRAM A
1 \emptyset 2w with 1 P.T. & 1 C.T.
Single Stator Meter(2W1 \emptyset) - Form 3S
5T Socket, Test Switch #TS04-0101

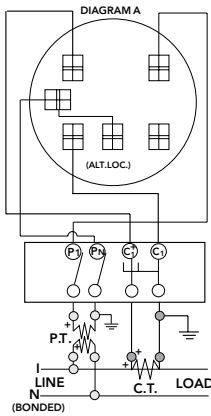

DIAGRAM B
1 \emptyset 3w with 1 C.T.
Single Stator Meter(2W1 \emptyset) - Form 3S
5T Socket, Test Switch #TS04-0101

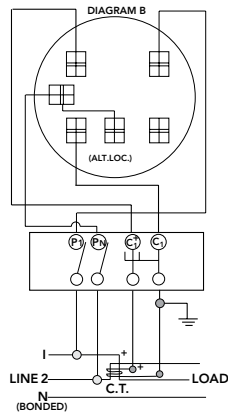

DIAGRAM C
1 \emptyset 3w with 2 C.T.'s
Single Stator Meter(3W1 \emptyset) - Form 4S
6T Socket, Test Switch #TS07-0105

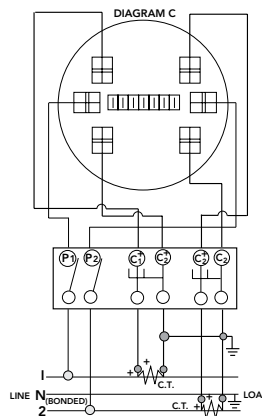

DIAGRAM D
1 \emptyset 3w or 3W Network with 2 C.T.'s
2 Stator Meter - Form 5S
8T Socket, Test Switch #TS07-0105

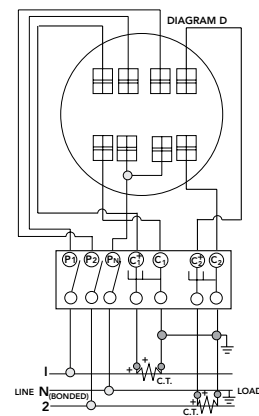

DIAGRAM E
3 \emptyset 3w "Δ" with 2 P.T.'s & 2 C.T.'s
2 Stator Meter - Form 5S
8T Socket, Test Switch #TS07-0105

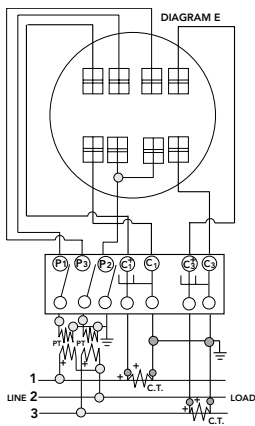

DIAGRAM F
3 \emptyset 3w "Δ" with 2 C.T.'s
2 Stator Meter - Form 5S
8T Socket, Test Switch #TS07-0105

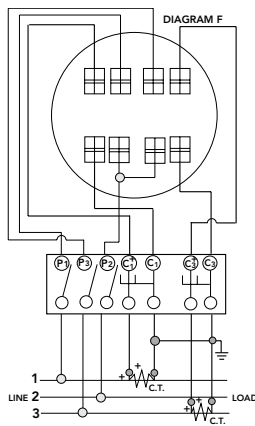

DIAGRAM G
3 \emptyset 4w "Y" with 3 C.T.'s
2 1/2 Stator Meter - Form 6S
13T Socket, Test Switch #TS10-0109

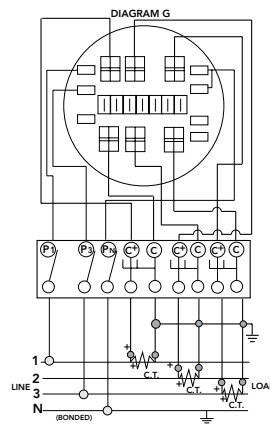

DIAGRAM H
3 \emptyset 4w "Y" with 2 P.T.'s & 3 C.T.'s
2 1/2 Stator Meter - Form 6S
13T Socket, Test Switch #TS10-0109

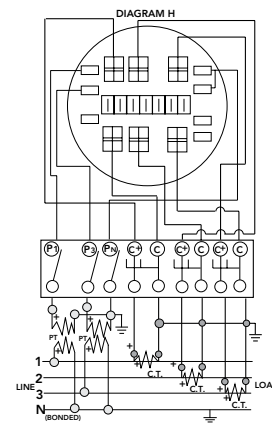

DIAGRAM I
3 \emptyset 4w "Y" or "Δ" with 3 C.T.'s
"Y" 3 Stator Meter - Form 9S
"Δ" 2 Stator Meter - Form 8S
13T Socket, Test Switch #TS10-0109

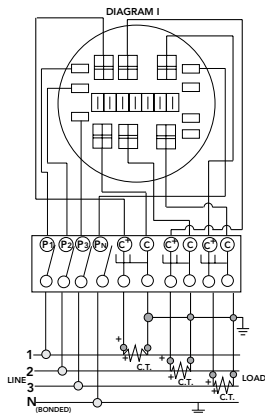
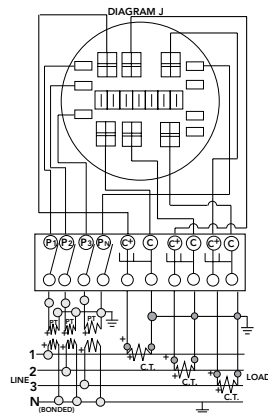

DIAGRAM J
3 \emptyset 4w "Y" with 3 P.T.'s & 3 C.T.'s
3 Stator Meter - Form 9S
13T Socket, Test Switch #TS10-0109



Prewiring: If standard factory prewiring is required, refer to wiring diagrams on this page. Determine appropriate diagram and send a copy with order. If custom factory prewiring is required, specify on order. Be sure to include meter socket catalog number, test switch make and catalog number, meter form number and provide a copy of your wiring diagram.

Please consult serving utility for their requirements prior to ordering or installing, as specifications and approvals vary by utility, and may require local electrical inspector approval. All installations must be installed by a licensed electrician and must comply with all national and local codes, laws and regulations. Milbank reserves the right to make changes in specifications and features shown without notice or obligation.



Watthour Meter Forms

Standard Forms | Transformer Rated or Self-Contained

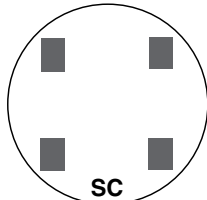

SC
2 and 3-WIRE FORMS
1S & 2S

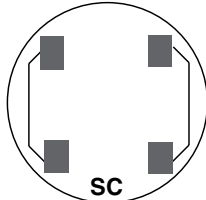

SC
2 and 3-WIRE FORMS
1S & 2S with BYPASS

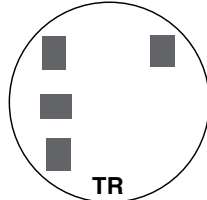

TR
2-WIRE FORM 3S
5th Term. 9 o'clock

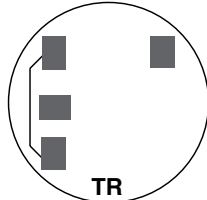

TR
2-WIRE FORM 3S
with BYPASS

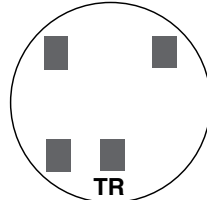

TR
2-WIRE FORM 3S
5th Term. 6 o'clock

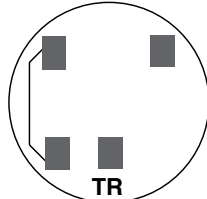

TR
2-WIRE FORM 3S
with BYPASS

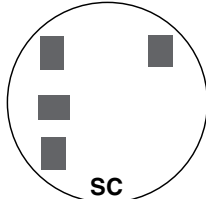

SC
2 ELEMENT
3-WIRE NETWORK
FORM 12S 5th
TERM. 9 o'clock

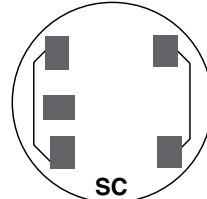

SC
2 ELEMENT 3-WIRE
NETWORK FORM 12S
with BYPASS
5th Term. 9 o'clock

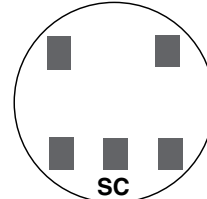

SC
2 ELEMENT
3-WIRE NETWORK
FORM 12S 5th
TERM. 6 o'clock

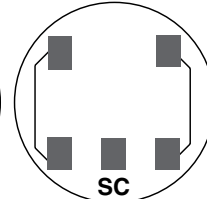

SC
2 ELEMENT 3-WIRE
NETWORK FORM 12S
with BYPASS
5th Term. 6 o'clock

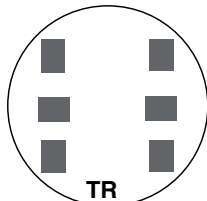

TR
3-WIRE FORM 4S

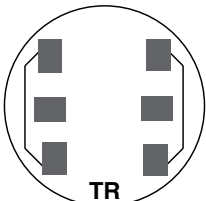

TR
3-WIRE FORM 4S
WITH BYPASS

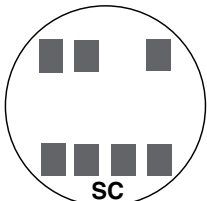

SC
2 or 3 ELEMENT
3Ø4W Y or
Y FORM 14S
FORM 15S
Y FORM 16S

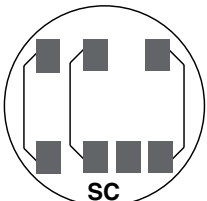

SC
2 or 3 ELEMENT
3Ø4W Y or
FORMS 14S & 15S
with BYPASS

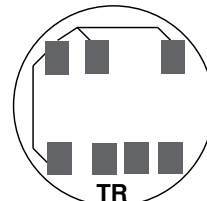

TR
2 ELEMENT
3Ø4W Y or
Y FORM 7S
FORM 24S
with BYPASS

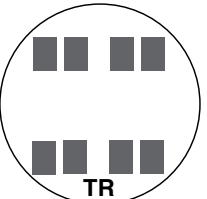

TR
2 ELEMENT
2Ø3W, 2Ø4W, 3Ø3W
FORM 5S

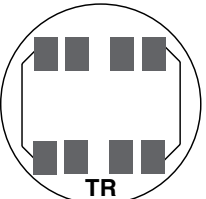

TR
2 ELEMENT 2Ø3W,
2Ø4W, 3Ø3W
FORM 5S with
BYPASS

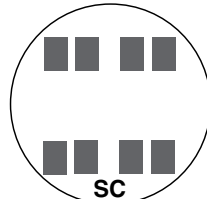

SC
2 ELEMENT
2Ø3W, 2Ø4W, 3Ø3W
FORM 13S

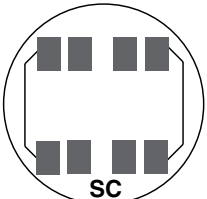

SC
2 or 3 ELEMENT
2Ø3W, 2Ø4W, 3Ø3W
FORM 13S with
BYPASS

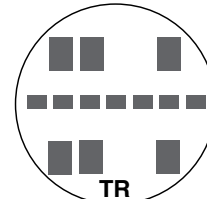

TR
2 or 3 ELEMENT
3Ø4W Y or
Y FORM 9S
FORM 8S

TR = TRANSFORMER RATED
SC = SELF CONTAINED

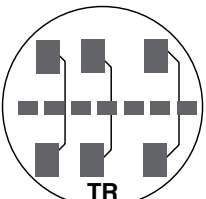

TR
2 or 3 ELEMENT
3Ø4W Y or
FORMS 8S & 9S
FORMS 8S & 9S
with BYPASS

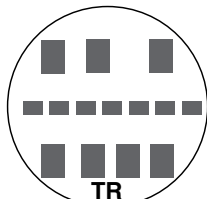

TR
2 ELEMENT
3Ø4W Y
FORM 6S

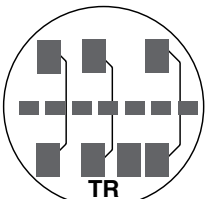

TR
2 ELEMENT
3Ø4W Y
FORM 6S
with BYPASS



Please consult serving utility for their requirements prior to ordering or installing, as specifications and approvals vary by utility, and may require local electrical inspector approval. All installations must be installed by a licensed electrician and must comply with all national and local codes, laws and regulations. Milbank reserves the right to make changes in specifications and features shown without notice or obligation.

Standard NEMA Configurations

Reference Information Only

2 Pole | 3 Wire | Grounding Receptacles

Straight Blade Wiring Devices				Twist-Lock Wiring Devices				
Volts	Code	15 amp	20 amp	30 amp	50 amp	15 amp	20 amp	30 amp
125	5							
		5-15R	5-20R	5-30R	5-50R	L5-15R	L5-20R	L5-30R
250	6							
		6-15R	6-20R	6-30R	6-50R	L6-15R	L6-20R	L6-30R
277 VAC	7							
		7-15R	7-20R	7-30R	7-50R	L7-15R	L7-20R	L7-30R

3 Pole | 3 Wire | Special Applications

Straight Blade Wiring Devices			Twist-Lock Wiring Devices		
Volts	Code	20 amp	30 amp	20 amp	30 amp
125V 250V	10				
		10-20R	10-30R	L10-20R	L10-30R

3 Pole | 4 Wire | Grounding

Straight Blade Wiring Devices				Twist-Lock			
Volts	Code	15 amp	20 amp	30 amp	50 amp	20 amp	30 amp
125V 250V	14						
		14-15R	14-20R	14-30R	14-50R	L14-20R	L14-30R

2 Pole | 3 Wire | Grounding | NEMA Trailer

Straight Blade Wiring Devices		
Volts	Code	30 amp
125V	TT	

Please consult serving utility for their requirements prior to ordering or installing, as specifications and approvals vary by utility, and may require local electrical inspector approval. All installations must be installed by a licensed electrician and must comply with all national and local codes, laws and regulations. Milbank reserves the right to make changes in specifications and features shown without notice or obligation.



6002.....	76	K2381	77	NU8980-O-KK-LP	52	U2734-XT.....	30
6003.....	76	K3082	76	NU8980-O-SF100-KK	52	U2734-XT.....	31
6116.....	76	K3083	76	NU8980-O-SF100-KK-LP	52	U2735-XT.....	30
105J.....	65	K3441	76	PT48AL.....	45	U2735-XT.....	31
363010-CT3R.....	44	K3442	76	PT48AR.....	45	U2736-XT.....	30
363016-CT3R.....	44	K3865	65	Q120.....	57	U2736-XT.....	31
363610-CT3R.....	44	K3865	77	Q130.....	57	U2862-X.....	31
363612-CT3R.....	44	K3866	77	Q250.....	57	U2863-X.....	31
363616-CT3R.....	44	K4527	78	S1848.....	78	U2864-X.....	31
483616-CT3R.....	44	K4528	78	S1890-XT	48	U2865-X.....	31
484812-CT3R.....	44	K4529	78	S1891-XT	48	U2866-X.....	31
5T8K2	77	K4530	78	S2571.....	78	U3328-RXL.....	11
606013-CT3R.....	44	K4694	78	S2674-XT	48	U3358-O-KK	50
A7514	75	K4722	46	S2690-XT	48	U3499-XL-100.....	17
A7515	75	K4729	46	S2777-4X.....	49	U3802	6
A7516	75	K4797	46	S2811-4X.....	49	U3812	6
A7517	75	K4798	46	S3488.....	78	U3822-20GWR.....	7
A7518	75	K4802	77	S3831-XT	48	U3832	6
A7551	75	K4977-EXT.....	78	S3912-XT	48	U3849-O-2/200.....	59
A8110	75	K4977-INT	78	S4084-O.....	60	U3850-O-TG	9
A8111	75	K5022-INT	78	S8324.....	75	U3862	6
A8112	75	K5039	57	S8988.....	78	U4013-X.....	16
A9064	75	K5193	57	S9148-200.....	58	U4015-O	10
A-GP	76	K5194	57	U1079-R.....	14	U4322-O-(AMP)	55
AP6014-O-400-NKO.....	48	K5400-BRIDGE-2POS....	57	U1129-O-K3L-K2L.....	14	U4323-O-(AMP)	55
AP6015-O-400-NKO.....	48	K5415	57	U1207-RL.....	11	U4372-XT-5T9.....	35
BL7474.....	78	K5800	78	U1211-RXL.....	11	U4373-XT-5T9.....	35
BL7499.....	78	K5815	76	U1252-X.....	28	U4374-XT-5T9.....	35
CP-16PDMNT-CALT.....	65	K5820	76	U1252-X.....	29	U4375-XT-5T9.....	35
CP-21	76	K5830	76	U1253-X.....	28	U4376-XT-5T9.....	35
CP-24PDMNT-CALT.....	65	K5930	46	U1253-X.....	29	U4413-O	9
CP-ABK5/8.....	65	K5931	46	U1254-X.....	28	U4490-XL	40
CP-PE-HOA-3POS	65	K5932	46	U1254-X.....	29	U4492-XL	40
CP-TC24H.....	65	K5933	46	U1255-X.....	28	U4493-XL	40
CP-TC7D.....	65	K5935-10GR	57	U1255-X.....	29	U4494-XL	40
CP-TCWIRE.....	65	K5935-11GR	57	U1256-X.....	28	U4496-XL	40
CT244811-HC.....	45	K5935-2/1450.....	57	U1256-X.....	29	U4497-XL	40
CT244811-SC	45	K5935-36GR	57	U1748-O	59	U4505-X.....	14
CT304811-HC.....	45	K5935-41	57	U1779-RRL-K3-K2.....	14	U4517-DL-M4	10
CT304811-SC	45	K5935-54	57	U1797-O-K3L-K2L.....	15	U4518-O-W	10
CT364811-HC.....	45	K5T	57	U1980-O	9	U4532-XL	9
CT364811-SC	45	K5T	77	U2161-XT.....	47	U4540-XL	61
K1047	77	K8180	76	U2228-XT.....	47	U4542-XL	61
K1190	77	M5-144	77	U2229-XT.....	47	U4544-XL	61
K1350	76	MR-2	76	U2448-X.....	15	U4546-XL	61
K1350L.....	76	MR2-SS	76	U2594-X.....	16	U4548-RXL.....	61
K1539	76	MR-4	76	U2732-XT.....	30	U4549-RXL.....	61
K1540	76	NU8980-O-200-KK	52	U2732-XT.....	31	U4702-X.....	14
K1540L.....	76	NU8980-O-200-KK-LP ...	52	U2733-XT.....	30	U4911-X-BL.....	16
K1541	76	NU8980-O-KK.....	52	U2733-XT.....	31	U5059-X-2/200-K3L.....	24



Please consult serving utility for their requirements prior to ordering or installing, as specifications and approvals vary by utility, and may require local electrical inspector approval. All installations must be installed by a licensed electrician and must comply with all national and local codes, laws and regulations. Milbank reserves the right to make changes in specifications and features shown without notice or obligation.

U5136-O-100S..... 53	U5880-RXL-200-BL 23	U8216-XL..... 27	UQFB-175-X1 74
U5136-O-200S..... 53	U5882-X..... 33	U8303-O-CECHA..... 50	UQFB-200..... 74
U5137-O-100S..... 53	U5883-X..... 33	U8436-O-CECHA..... 50	UQFB-200-X1 74
U5137-O-200S..... 53	U5884-X..... 33	U9107-O-CEHCA..... 51	UQFBH-100 74
U5161-X..... 15	U5885-X..... 33	U9107-O-WI 51	UQFBH-125 74
U5168-XTL-100..... 20	U5886-X..... 33	U9108-O-CECHA..... 51	UQFBH-150 74
U5168-XTL-100-KK..... 20	U5890-X-2/200 24	U9108-O-WI 51	UQFBH-175 74
U5168-XTL-100-KK-5T... 20	U5891-X-2/200 24	U9550-RRL..... 12	UQFBH-200 74
U5168-XTL-150..... 20	U5892-X-2/200 24	U9551-RXL..... 12	UQFBH-M-100..... 74
U5168-XTL-150-KK..... 20	U5893-X-2/200 24	U9581-RXL-QG..... 12	UQFBH-M-125..... 74
U5168-XTL-150-KK-5T... 20	U5894-X-2/200 24	U9647N-RL-200..... 19	UQFBH-M-150..... 74
U5168-XTL-200..... 20	U5895-X-2/200 24	U9648-RL-100..... 19	UQFBH-M-175..... 74
U5168-XTL-200-KK..... 20	U5898-O-200..... 22	U9700-RRL..... 13	UQFBH-M-200..... 74
U5168-XTL-200-KK-5T... 20	U5902-X..... 33	U9701-RXL..... 13	UQFP-100 74
U5169-XTL-100..... 21	U5903-X..... 33	U9800-RRL..... 12	UQFP-125 74
U5169-XTL-200..... 21	U5904-X..... 33	U9801-RXL..... 12	UQFP-150 74
U5268-XTL-150..... 20	U5905-X..... 33	U9865-RRL..... 12	UQFP-175 74
U5268-XTL-150-KK..... 20	U5906-X..... 33	UAP5024-XL 22	UQFP-200..... 74
U5268-XTL-200..... 20	U5925-O-100..... 54	UAP6094-O..... 62	UQFPH-100 74
U5268-XTL-200-KK..... 20	U5925-O-200..... 54	UAP6095-O..... 62	UQFPH-125 74
U5269-XTL-200..... 21	U5929-XL..... 8	UAP6096-O..... 62	UQFPH-150 74
U5701-O-100S..... 56	U5934-XL-BLG 8	UC1290-XL 38	UQFPH-175 74
U5701-O-200S..... 56	U5972-XT..... 36	UC1291-RL..... 38	UQFPH-200 74
U5701-O-5T9..... 56	U5973-XT..... 36	UC1299-XL 38	UQFPH-M-100 74
U5702-O-100S..... 56	U5974-XT..... 36	UC1300-RL..... 38	UQFPH-M-125 74
U5702-O-200S..... 56	U5975-XT..... 36	UC7233-XL 38	UQFPH-M-150 74
U5702-O-5T9..... 56	U5976-XT..... 36	UC7235-XL 38	UQFPH-M-175 74
U5750-RXL-200-BL 23	U6115-x-2/200-K7L..... 24	UC7237-XL 38	UQFPH-M-200 74
U5764-X-200-CB..... 26	U6220-O-100-10GR..... 54	UC7442-RL..... 39	UQFP-M-100..... 74
U5765-X-200-CB..... 26	U6220-O-200-10GR..... 54	UC7444-RL..... 39	UQFP-M-125..... 74
U5767-X-200-CB..... 26	U6221-O-100-10GR..... 56	UC7445-RL..... 39	UQFP-M-150..... 74
U5784-O-200-CB..... 26	U6221-O-200-10GR..... 56	UC7446-RL..... 39	UQFP-M-175..... 74
U5787-O-200-CB..... 26	U6227-X-400-K3 25	UC7448-RL..... 39	UQFP-M-200..... 74
U5794-X-400-CB..... 26	U6228-X-400-K3 25	UC7449-RL..... 39	Z1148210..... 57
U5796-X-400-CB..... 26	U6229-X-400-K7 25	UC7450-RL..... 39	Z701776-MO 57
U5797-O-400-CB..... 26	U6230-X-400-K7 25	UC7460-RL..... 39	Z708080-MO 57
U5799-O-400-CB..... 26	U7017-RL-TG 10	UC7461-RL..... 39	Z708767-MO 57
U5818-RL-200S..... 22	U7018-XL-TG 10	UC7478-RL..... 39	Z802965-AC..... 78
U5842-RL-100..... 18	U7021-RL-TG 9	UC7532-RL..... 39	Z814898-AC..... 78
U5842-RL-200..... 18	U7040-RL-TG 9	UC7544-RL..... 38	Z819294-SC..... 57
U5842-RL-KK 18	U7043-XL-TG 9	UC7545-RL..... 38	Z901925-AC..... 78
U5844-PXL-100..... 18	U7423-RXL..... 11	UC7582-XL 38	Z903274-AO 78
U5844-PXL-200..... 18	U7487-RL-TG 8	UC7636-RL..... 39	Z904486-AO 78
U5844-RL 18	U7487-RL-TG-KK 8	UQFB-100..... 74	Z916264-AO 78
U5852-RL 18	U7490-RL-TG 8	UQFB-100-X1 74	Z916265-AO 78
U5852-RL-200..... 18	U8144-RL 17	UQFB-125..... 74	
U5854-PXL-200..... 18	U8212-RL..... 27	UQFB-125-X1 74	
U5854-RL 18	U8213-RL..... 27	UQFB-150..... 74	
U5871-XL-200..... 23	U8214-RL..... 27	UQFB-150-X1 74	
U5872-XL-200..... 23	U8215-RL..... 27	UQFB-175..... 74	

Please consult serving utility for their requirements prior to ordering or installing, as specifications and approvals vary by utility, and may require local electrical inspector approval. All installations must be installed by a licensed electrician and must comply with all national and local codes, laws and regulations. Milbank reserves the right to make changes in specifications and features shown without notice or obligation.



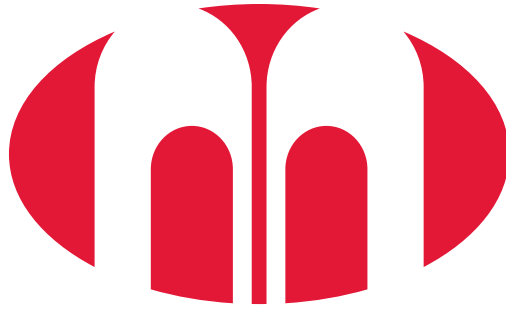

MILBANK[®]

ENERGY AT WORK

